



HSE18-B4A1BA

H18 Sure Sense

HYBRID PHOTOELECTRIC SENSORS

SICK
Sensor Intelligence.



Ordering information

Type	Part no.
HSE18-B4A1BA	1087754

Other models and accessories → www.sick.com/H18_Sure_Sense

Illustration may differ



Detailed technical data

Features

Functional principle	Through-beam photoelectric sensor	
Dimensions (W x H x D)	16.2 mm x 48.5 mm x 31.8 mm	
Housing design (light emission)	Hybrid	
Thread diameter (housing)	M18	
Mounting system type	M18, head/side (24.1 ... 25.4 mm)	
Housing color	Blue	
Sensing range max.	0 m ... 20 m	
Sensing range	0 m ... 15 m	
Type of light	Infrared light	
Light source	LED ¹⁾	
Light spot size (distance)	1,400 mm (10 m)	
Wave length	850 nm	
Adjustment		
	Potentiometer, right	None
	Potentiometer, left	None
Special features	Signal strength light bar	

¹⁾ Average service life: 100,000 h at T_J = +25 °C.

Mechanics/electronics

Supply voltage	10 V DC ... 30 V DC
-----------------------	---------------------

- ¹⁾ May not fall below or exceed U_V tolerances.
- ²⁾ Without signal strength light bar and load.
- ³⁾ Signal transit time with resistive load.
- ⁴⁾ With light/dark ratio 1:1.
- ⁵⁾ A = V_S connections reverse-polarity protected.
- ⁶⁾ B = inputs and output reverse-polarity protected.
- ⁷⁾ D = outputs overcurrent and short-circuit protected.

Ripple	< 5 V _{pp} ¹⁾
Current consumption	≤ 20 mA ²⁾
Switching output	PNP, NPN
Switching mode	Light switching
Switching output detail	
Switching output Q1	PNP, Light switching
Switching output Q2	NPN, Light switching
Output current I_{max.}	≤ 100 mA
Response time	≤ 0.5 ms ³⁾
Switching frequency	1,000 Hz ⁴⁾
Connection type	Male connector M12, 4-pin
Circuit protection	A ⁵⁾ B ⁶⁾ D ⁷⁾
Protection class	III
Weight	18 g
Housing material	Plastic, VISTAL®
Optics material	Plastic, PMMA
Enclosure rating	IP67 IP69K
Items supplied	Fastening nut (1x), M18, plastic, black, flat
Electromagnetic compatibility (EMC)	EN 60947-5-2 (The sensor complies with the Radio Safety Requirements (EMC) for the industrial sector (Radio Safety Class A). It may cause radio interference if used in a residential area.)
Ambient operating temperature	-40 °C ... +70 °C
Ambient temperature, storage	-40 °C ... +75 °C
UL File No.	E189383

1) May not fall below or exceed U_y tolerances.

2) Without signal strength light bar and load.

3) Signal transit time with resistive load.

4) With light/dark ratio 1:1.

5) A = V_S connections reverse-polarity protected.

6) B = inputs and output reverse-polarity protected.

7) D = outputs overcurrent and short-circuit protected.

Connection type/pinouts

Connection type	Male connector M12, 4-pin
Pinouts_{Sender}	
BN 1	+ (L+)
WH 2	Not connected
BU 3	- (M)
BK 4	Test _{IN}
Pinouts_{Receiver}	
BN 1	+ (L+)
WH 2	Q ₂

BU 3 - (M)

BK 4 Q₁

Classifications

ECLASS 5.0	27270901
ECLASS 5.1.4	27270901
ECLASS 6.0	27270901
ECLASS 6.2	27270901
ECLASS 7.0	27270901
ECLASS 8.0	27270901
ECLASS 8.1	27270901
ECLASS 9.0	27270901
ECLASS 10.0	27270901
ECLASS 11.0	27270901
ECLASS 12.0	27270901
ETIM 5.0	EC002716
ETIM 6.0	EC002716
ETIM 7.0	EC002716
ETIM 8.0	EC002716
UNSPSC 16.0901	39121528

Dimensional drawing (Dimensions in mm (inch))

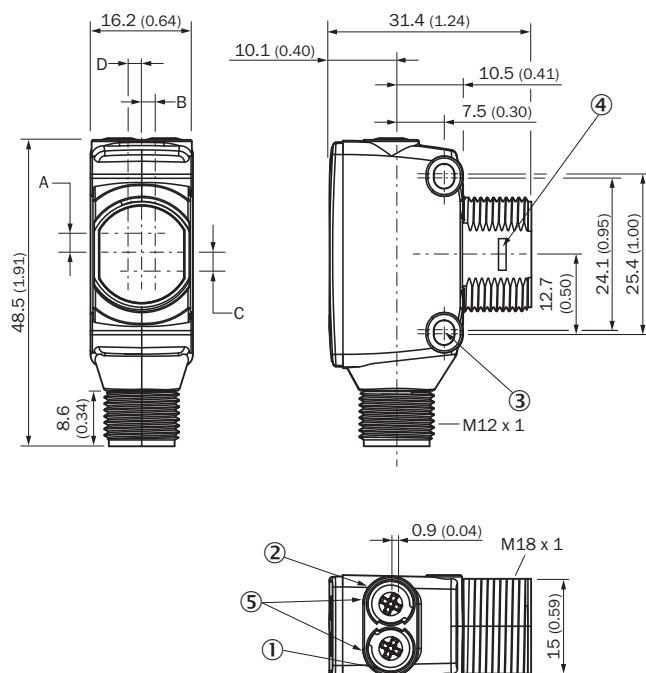

- ① LED indicator yellow: Status of received light beam
- ② LED indicator green: power on
- ③ M3 mounting hole
- ④ Snap Connection for flush ring (sold separately)
- ⑤ Potentiometer (if selected) or LED Indicators

Dimensions in mm (inch)	Receiver		Sender	
	A	B	C	D
HTB18 / HTF18	- 1.1 (0.04)	1.1 (0.04)	4.7 (0.19)	0.6 (0.02)
HTE18 / HL18 / HSE18	2.5 (0.1)	0.0 (0.0)	4.0 (0.16)	0.0 (0.0)
HTB18L / HTF18L / HL18L / HSE18L	2.5 (0.1)	0.0 (0.0)	3.5 (0.14)	0.0 (0.0)

Adjustments

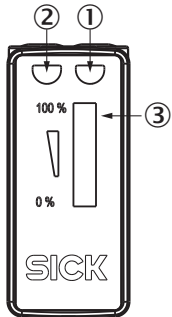

- ① LED indicator yellow: Status of received light beam
- ② LED indicator green: power on
- ③ Signal strength light bar

Connection type

Pinouts, see table Technical data: **Connection type/pinouts**

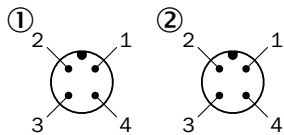

- ① Sender
- ② Receiver

Characteristic curve

Infrared light

Operating reserve

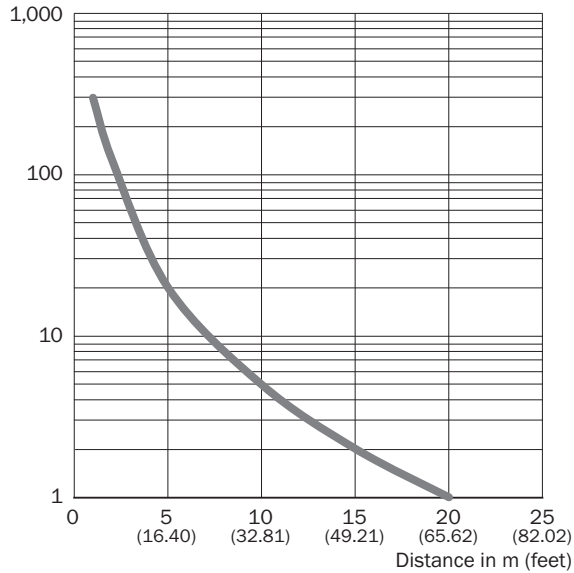

Light spot size

Infrared light

mm (inch)

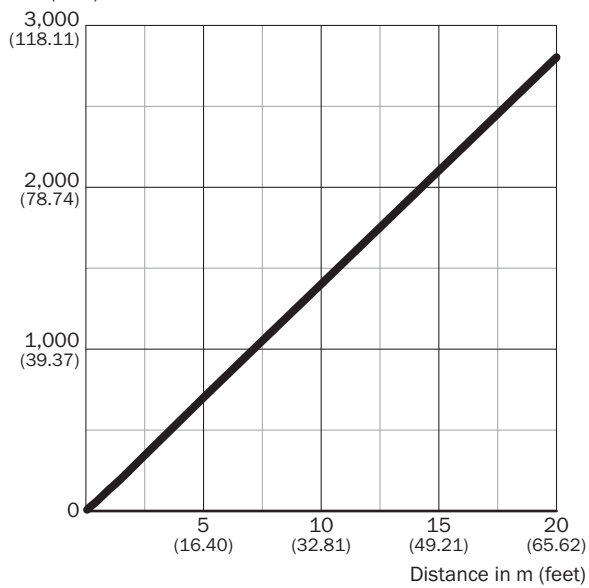

Dimensions in mm (inch)

Sensing range	Diameter
0.5 m (1.64 feet)	65 (0.21)
1 m (3.28 feet)	135 (5.31)
5 m (16.40 feet)	700 (27.56)
20 m (65.62 feet)	2,800 (110.24)

— Diameter

Sensing range diagram

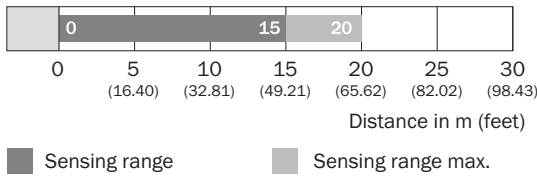

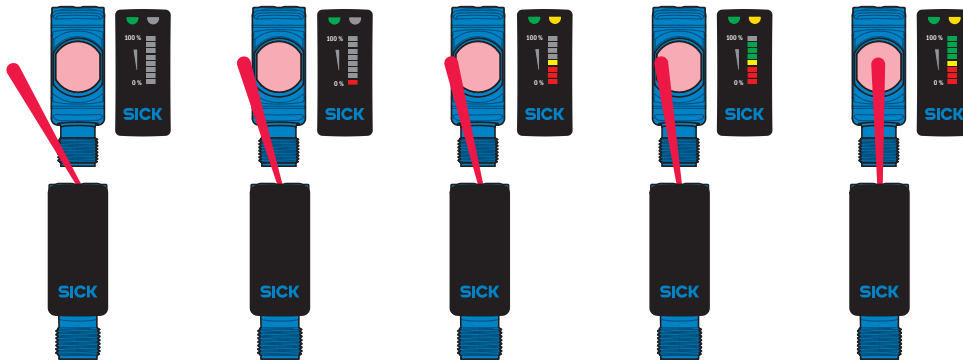

Functions



Recommended accessories

Other models and accessories → www.sick.com/H18_Sure_Sense

	Brief description	Type	Part no.
Others			
	<ul style="list-style-type: none"> • Connection type head A: Female connector, M12, 4-pin, straight, A-coded • Connection type head B: Flying leads • Signal type: Sensor/actuator cable • Cable: 5 m, 4-wire, PVC • Description: Sensor/actuator cable, unshielded • Application: Zones with chemicals, Uncontaminated zones 	YF2A14-050VB3XLEAX	2096235
	<ul style="list-style-type: none"> • Connection type head A: Male connector, M12, 4-pin, straight, A-coded • Description: Unshielded • Connection systems: Screw-type terminals • Permitted cross-section: ≤ 0.75 mm² 	STE-1204-G	6009932

SICK AT A GLANCE

SICK is one of the leading manufacturers of intelligent sensors and sensor solutions for industrial applications. A unique range of products and services creates the perfect basis for controlling processes securely and efficiently, protecting individuals from accidents and preventing damage to the environment.

We have extensive experience in a wide range of industries and understand their processes and requirements. With intelligent sensors, we can deliver exactly what our customers need. In application centers in Europe, Asia and North America, system solutions are tested and optimized in accordance with customer specifications. All this makes us a reliable supplier and development partner.

Comprehensive services complete our offering: SICK LifeTime Services provide support throughout the machine life cycle and ensure safety and productivity.

For us, that is “Sensor Intelligence.”

WORLDWIDE PRESENCE:

Contacts and other locations –www.sick.com