



# HSE18-P3B2BA

H18 Sure Sense

HYBRID PHOTOELECTRIC SENSORS

**SICK**  
Sensor Intelligence.



Illustration may differ



### Ordering information

Type	Part no.
HSE18-P3B2BA	1078792

Other models and accessories → [www.sick.com/H18\\_Sure\\_Sense](http://www.sick.com/H18_Sure_Sense)

### Detailed technical data

#### Features

<b>Functional principle</b>	Through-beam photoelectric sensor
<b>Dimensions (W x H x D)</b>	16.2 mm x 45.5 mm x 31.8 mm
<b>Housing design (light emission)</b>	Hybrid
<b>Thread diameter (housing)</b>	M18
<b>Mounting system type</b>	M18, head/side (24.1 ... 25.4 mm)
<b>Housing color</b>	Blue
<b>Sensing range max.</b>	0 m ... 25 m
<b>Sensing range</b>	0 m ... 20 m
<b>Type of light</b>	Visible red light
<b>Light source</b>	PinPoint LED <sup>1)</sup>
<b>Light spot size (distance)</b>	400 mm x 200 mm (10 m)
<b>Wave length</b>	631 nm
<b>Adjustment</b>	
	Potentiometer, right None
	Potentiometer, left None
<b>Special features</b>	Signal strength light bar

<sup>1)</sup> Average service life: 100,000 h at T<sub>J</sub> = +25 °C.

## Mechanics/electronics

<b>Supply voltage</b>	10 V DC ... 30 V DC
<b>Ripple</b>	$< 5 V_{pp}^{1)}$
<b>Current consumption</b>	$\leq 20 \text{ mA}^{2)}$
<b>Switching output</b>	PNP
<b>Output function</b>	Complementary
<b>Switching mode</b>	Light/dark switching
<b>Switching output detail</b>	
Switching output Q1	PNP, Light switching
Switching output Q2	PNP, Dark switching
<b>Output current <math>I_{max}</math></b>	$\leq 100 \text{ mA}$
<b>Response time</b>	$\leq 0.5 \text{ ms}^{3)}$
<b>Switching frequency</b>	$1,000 \text{ Hz}^{4)}$
<b>Connection type</b>	Cable with M8 male connector, 4-pin, 150 mm
<b>Cable material</b>	Plastic, PVC
<b>Conductor cross section</b>	$0.2 \text{ mm}^2$
<b>Circuit protection</b>	A <sup>5)</sup> B <sup>6)</sup> D <sup>7)</sup>
<b>Protection class</b>	III
<b>Weight</b>	18 g
<b>Housing material</b>	Plastic, VISTAL®
<b>Optics material</b>	Plastic, PMMA
<b>Enclosure rating</b>	IP67 IP69K
<b>Items supplied</b>	Fastening nut (1x), M18, plastic, black, flat
<b>Electromagnetic compatibility (EMC)</b>	EN 60947-5-2 (The sensor complies with the Radio Safety Requirements (EMC) for the industrial sector (Radio Safety Class A). It may cause radio interference if used in a residential area.)
<b>Ambient operating temperature</b>	$-40 \text{ °C} \dots +70 \text{ °C}$
<b>Ambient temperature, storage</b>	$-40 \text{ °C} \dots +75 \text{ °C}$
<b>UL File No.</b>	E189383

<sup>1)</sup> May not fall below or exceed  $U_V$  tolerances.

<sup>2)</sup> Without signal strength light bar and load.

<sup>3)</sup> Signal transit time with resistive load.

<sup>4)</sup> With light/dark ratio 1:1.

<sup>5)</sup> A =  $V_S$  connections reverse-polarity protected.

<sup>6)</sup> B = inputs and output reverse-polarity protected.

<sup>7)</sup> D = outputs overcurrent and short-circuit protected.

## Connection type/pinouts

<b>Connection type</b>	Cable with M8 male connector, 4-pin, 150 mm
<b>Connection type Detail</b>	
Conductor cross section	$0.2 \text{ mm}^2$
Cable material	Plastic

Pinouts <small>Sender</small>	
BN 1	+ (L+)
WH 2	Not connected
BU 3	- (M)
BK 4	Test <sub>IN</sub>
Pinouts <small>Receiver</small>	
BN 1	+ (L+)
WH 2	Q <sub>2</sub>
BU 3	- (M)
BK 4	Q <sub>1</sub>

### Classifications

<b>ECLASS 5.0</b>	27270901
<b>ECLASS 5.1.4</b>	27270901
<b>ECLASS 6.0</b>	27270901
<b>ECLASS 6.2</b>	27270901
<b>ECLASS 7.0</b>	27270901
<b>ECLASS 8.0</b>	27270901
<b>ECLASS 8.1</b>	27270901
<b>ECLASS 9.0</b>	27270901
<b>ECLASS 10.0</b>	27270901
<b>ECLASS 11.0</b>	27270901
<b>ECLASS 12.0</b>	27270901
<b>ETIM 5.0</b>	EC002716
<b>ETIM 6.0</b>	EC002716
<b>ETIM 7.0</b>	EC002716
<b>ETIM 8.0</b>	EC002716
<b>UNSPSC 16.0901</b>	39121528

**Dimensional drawing** (Dimensions in mm (inch))

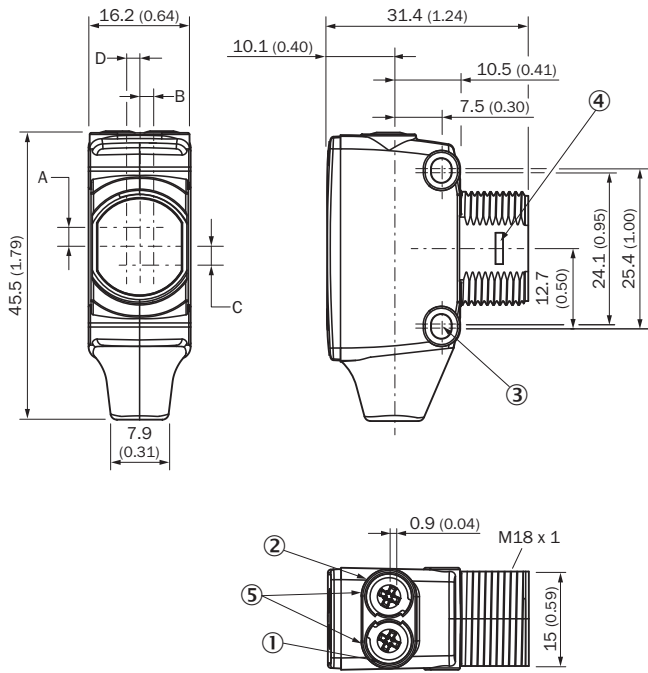

- ① LED indicator yellow: Status of received light beam
- ② LED indicator green: power on
- ③ M3 mounting hole
- ④ Snap Connection for flush ring (sold seperatly)
- ⑤ Potentiometer (if selected) or LED Indicators

Dimensions in mm (inch)	Receiver		Sender	
	A	B	C	D
<b>HTB18 / HTF18</b>	- 1.1 (0.04)	1.1 (0.04)	4.7 (0.19)	0.6 (0.02)
<b>HTE18 / HL18 / HSE18</b>	2.5 (0.1)	0.0 (0.0)	4.0 (0.16)	0.0 (0.0)
<b>HTB18L / HTF18L / HL18L / HSE18L</b>	2.5 (0.1)	0.0 (0.0)	3.5 (0.14)	0.0 (0.0)

**Adjustments**

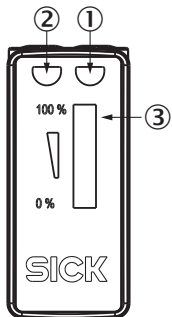

- ① LED indicator yellow: Status of received light beam
- ② LED indicator green: power on
- ③ Signal strength light bar

### Connection type

Pinouts, see table Technical data: **Connection type/pinouts**

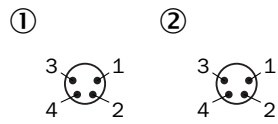

- ① Sender
- ② Receiver

### Characteristic curve

Red light

Operating reserve

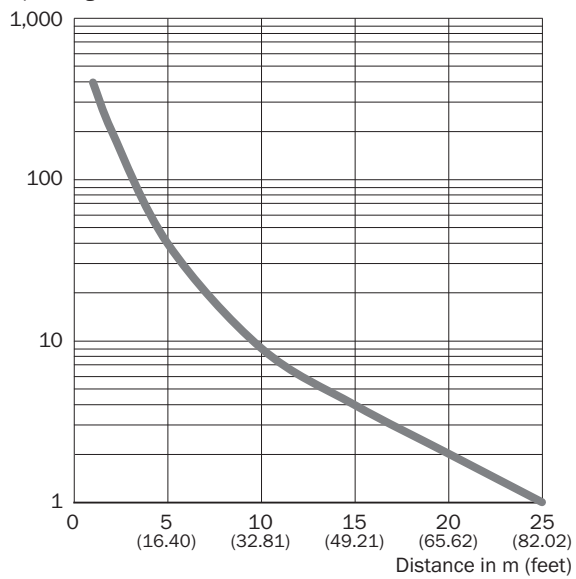

### Light spot size

Red light

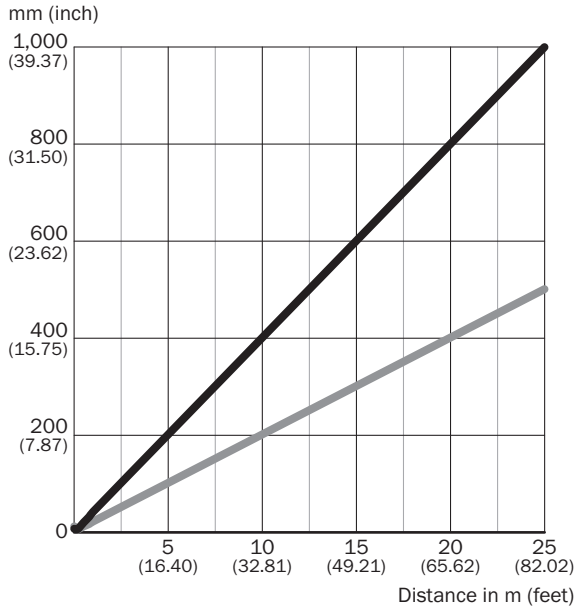

#### Dimensions in mm (inch)

Sensing range	Horizontal	Vertical
<b>0.5 m</b> <b>(1.64 feet)</b>	18 (0.71)	10 (0.39)
<b>1 m</b> <b>(3.28 feet)</b>	40 (1.57)	20 (0.79)
<b>6.5 m</b> <b>(21.33 feet)</b>	260 (10.24)	130 (5.12)
<b>25 m</b> <b>(82.02 feet)</b>	1,000 (39.37)	500 (19.67)

— Horizontal  
— Vertical

### Sensing range diagram

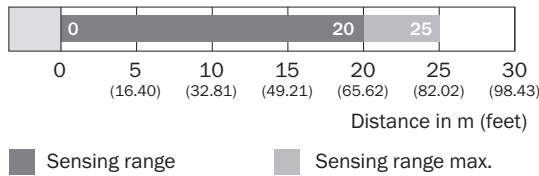

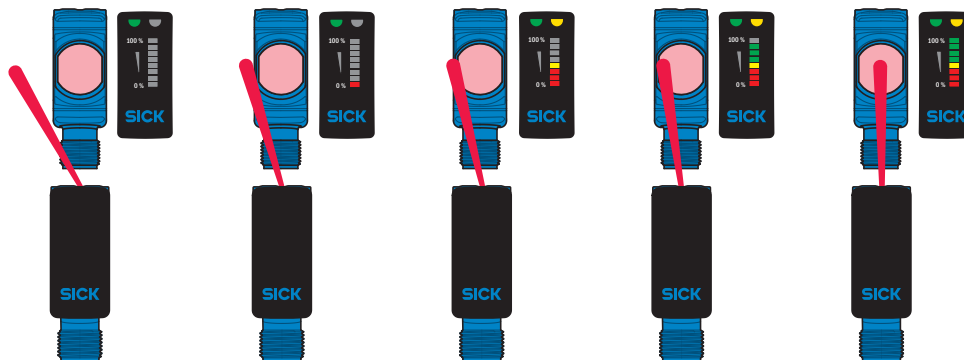

### Functions



### Recommended accessories

Other models and accessories → [www.sick.com/H18\\_Sure\\_Sense](http://www.sick.com/H18_Sure_Sense)

	Brief description	Type	Part no.
Others			
	<ul style="list-style-type: none"> <li>• <b>Connection type head A:</b> Female connector, M8, 4-pin, straight, A-coded</li> <li>• <b>Connection type head B:</b> Flying leads</li> <li>• <b>Signal type:</b> Sensor/actuator cable</li> <li>• <b>Cable:</b> 5 m, 4-wire, PVC</li> <li>• <b>Description:</b> Sensor/actuator cable, unshielded</li> <li>• <b>Application:</b> Zones with chemicals, Uncontaminated zones</li> </ul>	YF8U14-050VA3XLEAX	2095889
	<ul style="list-style-type: none"> <li>• <b>Connection type head A:</b> Male connector, M8, 4-pin, straight, A-coded</li> <li>• <b>Description:</b> Unshielded</li> <li>• <b>Connection systems:</b> Screw-type terminals</li> <li>• <b>Permitted cross-section:</b> 0.14 mm<sup>2</sup> ... 0.5 mm<sup>2</sup></li> </ul>	STE-0804-G	6037323



## SICK AT A GLANCE

SICK is one of the leading manufacturers of intelligent sensors and sensor solutions for industrial applications. A unique range of products and services creates the perfect basis for controlling processes securely and efficiently, protecting individuals from accidents and preventing damage to the environment.

We have extensive experience in a wide range of industries and understand their processes and requirements. With intelligent sensors, we can deliver exactly what our customers need. In application centers in Europe, Asia and North America, system solutions are tested and optimized in accordance with customer specifications. All this makes us a reliable supplier and development partner.

Comprehensive services complete our offering: SICK LifeTime Services provide support throughout the machine life cycle and ensure safety and productivity.

For us, that is “Sensor Intelligence.”

## WORLDWIDE PRESENCE:

Contacts and other locations –[www.sick.com](http://www.sick.com)