



I2D605C-2MCB71

midiCam2

2D MACHINE VISION

SICK
Sensor Intelligence.



Ordering information

Type	Part no.
I2D605C-2MCB71	6071832

Other models and accessories → www.sick.com/midiCam2



Detailed technical data

Features

Technology	2D snapshot
Product category	Streaming, flexible
Sensor	CMOS Color
Sensor used	Sony IMX264
Shutter technology	Global-Shutter
Illumination	To be ordered separately as accessories
Further functions	Line mode, area of interest, long exposure
Lens	C-mount
Optical format	2/3"
Note	To be ordered separately as accessories
Task	Measuring - Dimension, contour and volume Monitoring and controlling - Quality Identifying - Pattern Identifying - Classifying Identifying - Sorting

Mechanics/electronics

Connection type	M12, 8-pin male connector, A-coded (2 GPIOs, 1 digital input, 1 digital output)
Supply voltage	12 V ... 24 V ¹⁾
Power consumption	≤ 2.9 W
Enclosure rating	IP65 IP67
Weight	52 g
Dimensions (L x W x H)	42.7 mm x 53 mm x 41 mm

¹⁾ Or PoE.

Performance

Bit depth	12 bit
Sensor resolution	2,448 px x 2,048 px (5.01 Mpixel)
Sensor size	8.446 mm x 7.066 mm
Scan/frame rate	24 fps, in freerun mode
Memory	128 MB

Exposure time	0.035 ms ... 2,000 ms
Pixel size	3.45 µm x 3.45 µm

Interfaces

Ethernet	✓, UDP/IP
Data transmission rate	1,000 Mbit/s
Configuration software	SICK Vision Suite

Ambient data

Shock load	80 g, EN 60068-2-27 (1995-03), EN 60068-2-29 (1995-03)
Vibration load	10 g, 30 Hz ... 500 Hz, EN 60068-2-6 (1996-05)
Ambient operating temperature	0 °C ... +55 °C ¹⁾
Storage temperature	-20 °C ... +60 °C ¹⁾

¹⁾ Relative humidity: 0% ... 100%.

General notes

Note	Not free of paint wetting impairment substances.
-------------	--

Classifications

ECLASS 5.0	27310205
ECLASS 5.1.4	27310205
ECLASS 6.0	27310205
ECLASS 6.2	27310205
ECLASS 7.0	27310205
ECLASS 8.0	27310205
ECLASS 8.1	27310205
ECLASS 9.0	27310205
ECLASS 10.0	27310205
ECLASS 11.0	27310205
ECLASS 12.0	27310205
ETIM 5.0	EC001820
ETIM 6.0	EC001820
ETIM 7.0	EC001820
ETIM 8.0	EC001820
UNSPSC 16.0901	43211731

Dimensional drawing (Dimensions in mm (inch))

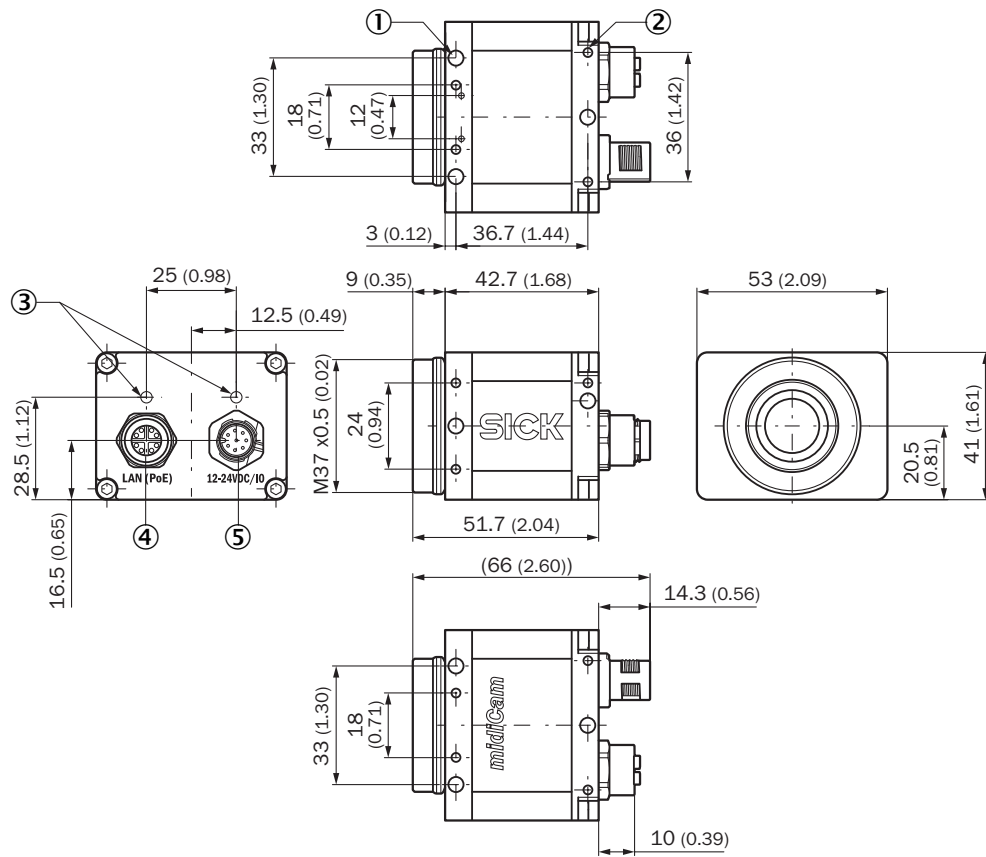

- ① M5 blind tapped holes, 6 mm deep (10 x), for mounting
- ② Blind hole thread M3, 5 mm deep (14 x), for mounting
- ③ LED for status display (2 x)
- ④ M12, 8-pin socket, X-coded (Gigabit Ethernet)
- ⑤ I/O power connection, male connector, M12, 8-pin, A coded, Binder

Field of view

Field of view y in mm (inch)

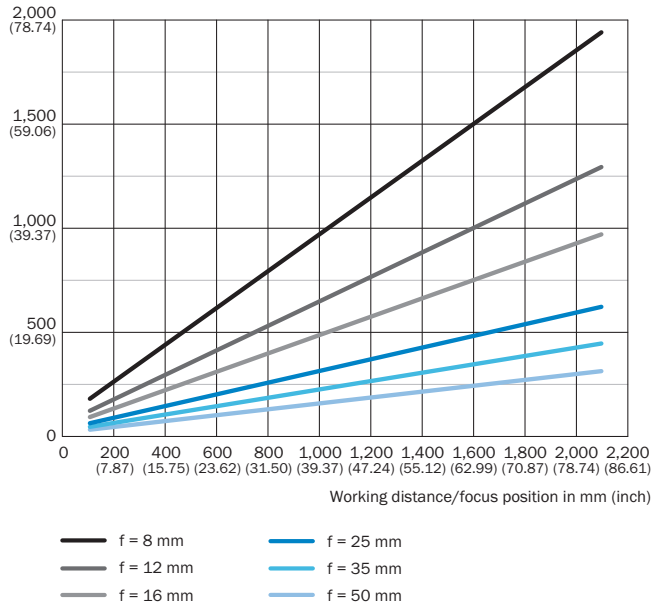

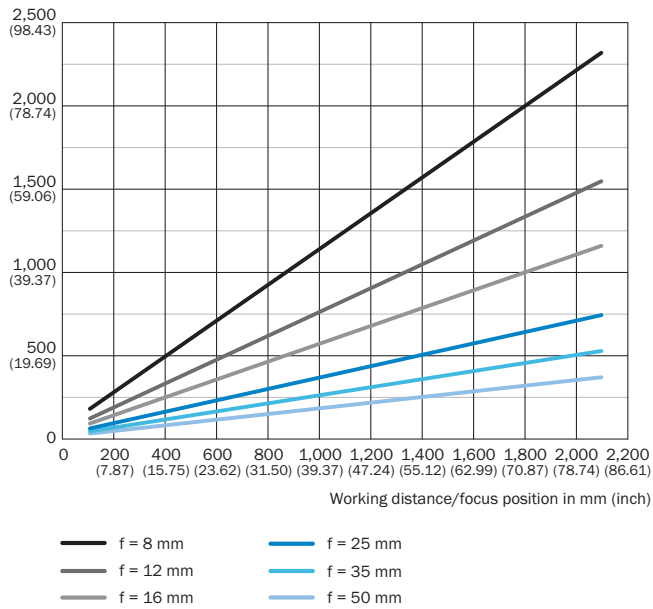

Field of view x in mm (inch)



Recommended accessories

Other models and accessories → www.sick.com/midiCam2

	Brief description	Type	Part no.
Others			
	<ul style="list-style-type: none"> Connection type head A: Male connector, M12, 5-pin, A-coded Connection type head B: Female connector, M12, 8-pin, A-coded Cable: 1 m Description: Shielded, Connecting cable for all midiCam(2) cameras to SIMxxxx M12 variants (sensor connection) 	YM2AA5-010UB6F2A28	2087091
	<ul style="list-style-type: none"> Connection type head A: Male connector, M12, 5-pin, A-coded Connection type head B: Female connector, M12, 8-pin, A-coded Cable: 3 m Description: Shielded, Connecting cable for all midiCam(2) cameras to SIMxxxx M12 variants (sensor connection) 	YM2AA5-030UB6F2A28	2087092
	<ul style="list-style-type: none"> Connection type head A: Male connector, M12, 5-pin, A-coded Connection type head B: Female connector, M12, 8-pin, A-coded Cable: 5 m Description: Shielded, Connecting cable for all midiCam(2) cameras to SIMxxxx M12 variants (sensor connection) 	YM2AA5-050UB6F2A28	2087093

Recommended services

Additional services → www.sick.com/midiCam2

	Type	Part no.
Extended warranty		
<ul style="list-style-type: none"> Product area: Machine vision, LiDAR sensors, safety camera sensors, Safety laser scanners, Safety radar sensors, Radar sensors, Fixed mount barcode scanners, Image-based code readers, RFID, Mobile handheld scanners Range of services: The services correspond to the scope of the statutory manufacturer warranty (SICK general terms of delivery). Duration: Five-year warranty from delivery date. 	Extended warranty for a total of five years from delivery date	1680671

SICK AT A GLANCE

SICK is one of the leading manufacturers of intelligent sensors and sensor solutions for industrial applications. A unique range of products and services creates the perfect basis for controlling processes securely and efficiently, protecting individuals from accidents and preventing damage to the environment.

We have extensive experience in a wide range of industries and understand their processes and requirements. With intelligent sensors, we can deliver exactly what our customers need. In application centers in Europe, Asia and North America, system solutions are tested and optimized in accordance with customer specifications. All this makes us a reliable supplier and development partner.

Comprehensive services complete our offering: SICK LifeTime Services provide support throughout the machine life cycle and ensure safety and productivity.

For us, that is “Sensor Intelligence.”

WORLDWIDE PRESENCE:

Contacts and other locations –www.sick.com