



IHM06-03BPSVT0G

IMM

INDUCTIVE PROXIMITY SENSORS

SICK
Sensor Intelligence.



Illustration may differ



Ordering information

Type	Part no.
IHM06-03BPSVTOG	1103982

Other models and accessories → www.sick.com/IMM

Detailed technical data

Features

Housing	Cylindrical
Housing	Extremely short model
Diameter	Ø 6.5 mm
Sensing range S_n	3 mm
Safe sensing range S_a	2.43 mm
Installation type	Flush
Switching frequency	1,500 Hz
Connection type	Connector M8, 3-pin
Switching output	PNP
Output function	NO
Electrical wiring	DC 3-wire
Enclosure rating	IP67 ¹⁾
Special features	Visual adjustment indicator, IO-Link, triple sensing range

¹⁾ According to EN 60529.

Mechanics/electronics

Supply voltage	10 V DC ... 30 V DC
Ripple	≤ 20 % ¹⁾
Voltage drop	≤ 2 V ²⁾
Time delay before availability	≤ 50 ms

¹⁾ Of V_S .

²⁾ With $I_a = 200$ mA.

³⁾ Supply voltage U_B and constant ambient temperature T_a .

Hysteresis	1 % ... 10 %
Reproducibility	≤ 2 % ³⁾
Temperature drift (of S_r)	≤ 10 %
EMC	EN 60947-5-2
Continuous current I_a	≤ 200 mA
Short-circuit protection	✓
Power-up pulse protection	✓
Shock and vibration resistance	30 g, 11 ms / 10 ... 55 Hz, 1 mm
Ambient operating temperature	-25 °C ... +70 °C
Housing material	Stainless steel V2A, DIN 1.4305 / AISI 303
Sensing face material	Plastic, LCP
Housing length	29 mm
UL File No.	NRKH.E348498

¹⁾ Of V_S.

²⁾ With I_a = 200 mA.

³⁾ Supply voltage U_B and constant ambient temperature T_a.

Safety-related parameters

MTTF_D	1,330 years
DC_{avg}	0 %

Communication interface

Communication interface	IO-Link V1.1
Communication Interface detail	COM2 (38,4 kBaud)
Cycle time	10.4 ms
Process data length	1 Byte
Process data structure	Bit 0 = Sr reached Bit 1 = Sa reached

Reduction factors

Note	The values are reference values which may vary
St37 steel (Fe)	1
Stainless steel (V2A, 304)	Approx. 0.75
Aluminum (Al)	Approx. 0.5
Copper (Cu)	Approx. 0.43
Brass (Br)	Approx. 0.54

Installation note

Remark	Associated graphic see "Installation"
B	10 mm
C	6.5 mm
D	9 mm
F	24 mm

Classifications

ECLASS 5.0	27270101
-------------------	----------

ECLASS 5.1.4	27270101
ECLASS 6.0	27270101
ECLASS 6.2	27270101
ECLASS 7.0	27270101
ECLASS 8.0	27270101
ECLASS 8.1	27270101
ECLASS 9.0	27270101
ECLASS 10.0	27270101
ECLASS 11.0	27270101
ECLASS 12.0	27274001
ETIM 5.0	EC002714
ETIM 6.0	EC002714
ETIM 7.0	EC002714
ETIM 8.0	EC002714
UNSPSC 16.0901	39122230

Installation note

Fixing with setscrew

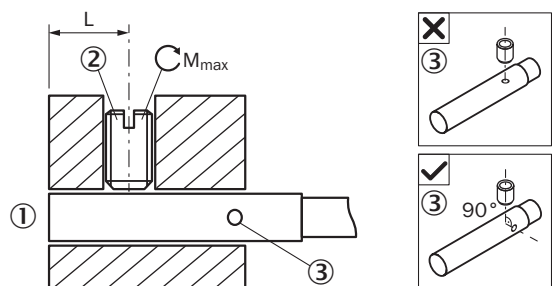

- ① Sensing face
- ② Recommended setscrew: M3, flat point
- ③ Display LED

Sensor type	Mounting area (L)	Max. tightening torque (M_{max})
IHM06-*****G	6 mm ... 11 mm	≤ 0.4 Nm
IHM06-*****TOG	6 mm ... 21 mm	≤ 0.4 Nm
IHM06-*****K	6 mm ... 21 mm	≤ 0.4 Nm
IHM06-*****TOK	6 mm ... 32 mm	≤ 0.4 Nm
IHM06-*****S	6 mm ... 32 mm	≤ 0.4 Nm
IHM06-*****TOS	6 mm ... 42 mm	≤ 0.4 Nm

Mounting using BEF-KH-M06 bracket

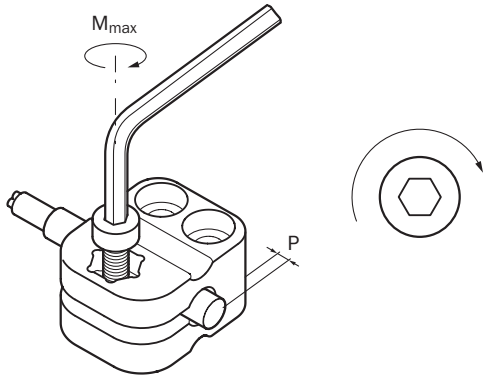

Sensor type	Mounting adapter	Overrun (P)	Max. tightening torque (M_{max})
IHM06-1B5***** IHM06-02B***** IHM06-03B*****	BEF-KH-M06, part no. 2101067	≥ 0 mm	≤ 0.6 Nm

Flush installation

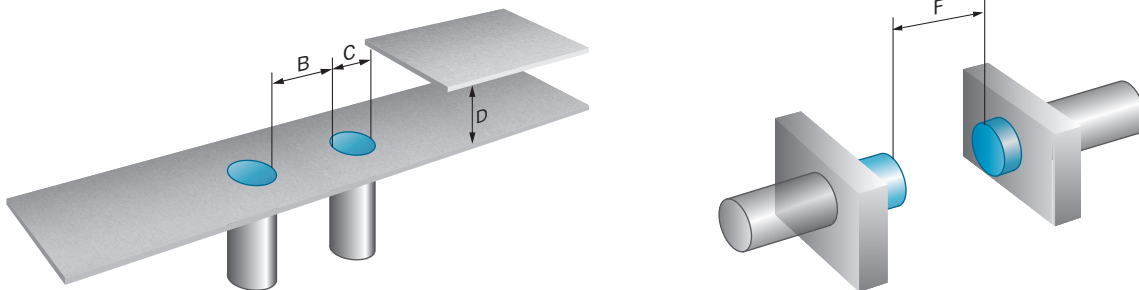

Connection diagram

Cd-002

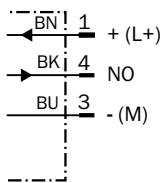

Response diagram

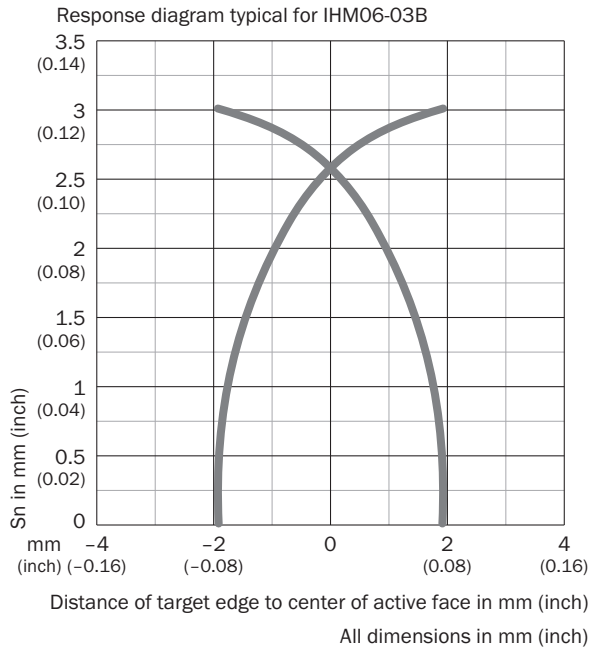

Functional principle

Installation aid

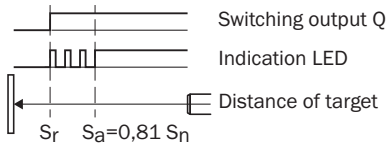

Dimensional drawing (Dimensions in mm (inch))



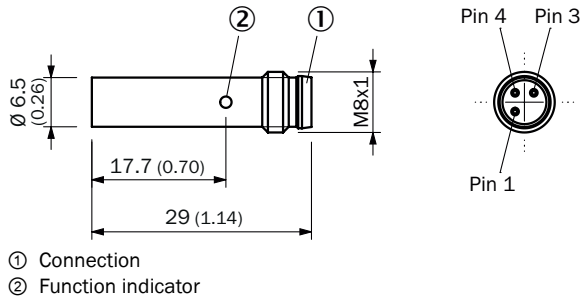







IHM06, extremely short variant, flush, male connector







Recommended accessories

Other models and accessories → www.sick.com/IMM

	Brief description	Type	Part no.
Terminal and alignment brackets			
	Plastic (PA6), without mounting hardware	BEF-KH-M06	2101067
Others			
	<ul style="list-style-type: none"> • Connection type head A: 3-pin • Number of slots: 4 • Slot connection type: M8, 3-pin, A-coded, female connector • Description: Unshielded 	Y8A34A2-C2A8000XXX	2115733
	<ul style="list-style-type: none"> • Connection type head A: 3-pin • Number of slots: 4 • Slot connection type: M8, 3-pin, A-coded, female connector • Cable: 5 m, 6-wire, PUR, halogen-free • Description: Unshielded • Application: Drag chain operation 	Y8A34A2-LXXXUAA050	2115727
	<ul style="list-style-type: none"> • Connection type head A: 3-pin • Number of slots: 6 • Slot connection type: M8, 3-pin, A-coded, female connector • Description: Unshielded 	Y8A36A2-C2A8000XXX	2115734
	<ul style="list-style-type: none"> • Connection type head A: 3-pin • Number of slots: 6 • Slot connection type: M8, 3-pin, A-coded, female connector • Cable: 5 m, 8-wire, PUR, halogen-free • Description: Unshielded • Application: Drag chain operation 	Y8A36A2-LXXXUBA050	2115728
	<ul style="list-style-type: none"> • Connection type head A: Male connector, M8, 3-pin, straight, A-coded • Description: Unshielded • Connection systems: Screw-type terminals • Permitted cross-section: 0.14 mm² ... 0.5 mm² 	STE-0803-G	6037322
	<ul style="list-style-type: none"> • Connection type head A: Male connector, M8, 3-pin, angled, A-coded • Description: Unshielded • Connection systems: Screw-type terminals • Permitted cross-section: 0.14 mm² ... 0.5 mm² 	STE-0803-WSK	6053170
	<ul style="list-style-type: none"> • Connection type head A: Female connector, M8, 3-pin, straight, A-coded • Connection type head B: Flying leads • Signal type: Sensor/actuator cable • Cable: 2 m, 3-wire, PUR, halogen-free • Description: Sensor/actuator cable, unshielded • Application: Zones with oils and lubricants, Drag chain operation, Robot 	YF8U13-020UA1XLEAX	2094782
	<ul style="list-style-type: none"> • Connection type head A: Female connector, M8, 3-pin, straight, A-coded • Connection type head B: Flying leads • Signal type: Sensor/actuator cable • Cable: 5 m, 3-wire, PUR, halogen-free • Description: Sensor/actuator cable, unshielded • Application: Zones with oils and lubricants, Drag chain operation, Robot 	YF8U13-050UA1XLEAX	2094788
	<ul style="list-style-type: none"> • Connection type head A: Female connector, M8, 3-pin, straight, A-coded • Connection type head B: Flying leads • Signal type: Sensor/actuator cable • Cable: 2 m, 3-wire, PVC • Description: Sensor/actuator cable, unshielded • Application: Zones with chemicals 	YF8U13-020VA1XLEAX	2095860

	Brief description	Type	Part no.
	<ul style="list-style-type: none"> • Connection type head A: Female connector, M8, 3-pin, straight, A-coded • Connection type head B: Flying leads • Signal type: Sensor/actuator cable • Cable: 5 m, 3-wire, PVC • Description: Sensor/actuator cable, unshielded • Application: Zones with chemicals 	YF8U13-050VA1XLEAX	2095884
	<ul style="list-style-type: none"> • Connection type head A: Female connector, M8, 3-pin, angled, A-coded • Connection type head B: Flying leads • Signal type: Sensor/actuator cable • Cable: 2 m, 3-wire, PUR, halogen-free • Description: Sensor/actuator cable, unshielded • Application: Zones with oils and lubricants, Drag chain operation, Robot 	YG8U13-020UA1XLEAX	2094794
	<ul style="list-style-type: none"> • Connection type head A: Female connector, M8, 3-pin, angled, A-coded • Connection type head B: Flying leads • Signal type: Sensor/actuator cable • Cable: 5 m, 3-wire, PUR, halogen-free • Description: Sensor/actuator cable, unshielded • Application: Zones with oils and lubricants, Drag chain operation, Robot 	YG8U13-050UA1XLEAX	2095586
	<ul style="list-style-type: none"> • Connection type head A: Female connector, M8, 3-pin, angled, A-coded • Connection type head B: Flying leads • Signal type: Sensor/actuator cable • Cable: 2 m, 3-wire, PVC • Description: Sensor/actuator cable, unshielded • Application: Zones with chemicals 	YG8U13-020VA1XLEAX	2096165
	<ul style="list-style-type: none"> • Connection type head A: Female connector, M8, 3-pin, angled, A-coded • Connection type head B: Flying leads • Signal type: Sensor/actuator cable • Cable: 5 m, 3-wire, PVC • Description: Sensor/actuator cable, unshielded • Application: Zones with chemicals 	YG8U13-050VA1XLEAX	2096166
	<ul style="list-style-type: none"> • Connection type head A: Female connector, M8, 3-pin, straight, A-coded • Connection type head B: Male connector, M12, 3-pin, straight, A-coded • Signal type: Sensor/actuator cable • Cable: 2 m, 3-wire, PUR, halogen-free • Description: Sensor/actuator cable, unshielded • Application: Zones with oils and lubricants, Drag chain operation, Robot 	YF8U13-020UA1M2A13	2096169
	<ul style="list-style-type: none"> • Connection type head A: Female connector, M8, 3-pin, straight, A-coded • Connection type head B: Male connector, M12, 3-pin, straight, A-coded • Signal type: Sensor/actuator cable • Cable: 5 m, 3-wire, PUR, halogen-free • Description: Sensor/actuator cable, unshielded • Application: Zones with oils and lubricants, Drag chain operation, Robot 	YF8U13-050UA1M2A13	2096170
	<ul style="list-style-type: none"> • Connection type head A: Female connector, M8, 3-pin, straight, A-coded • Connection type head B: Male connector, M12, 3-pin, straight, A-coded • Signal type: Sensor/actuator cable • Cable: 2 m, 3-wire, PVC • Description: Sensor/actuator cable, unshielded • Application: Zones with chemicals 	YF8U13-020VA1M2A13	2096605
	<ul style="list-style-type: none"> • Connection type head A: Female connector, M8, 3-pin, straight, A-coded • Connection type head B: Male connector, M12, 3-pin, straight, A-coded • Signal type: Sensor/actuator cable • Cable: 5 m, 3-wire, PVC • Description: Sensor/actuator cable, unshielded • Application: Zones with chemicals 	YF8U13-050VA1M2A13	2096606
	<ul style="list-style-type: none"> • Connection type head A: Female connector, M8, 3-pin, angled, A-coded • Connection type head B: Male connector, M12, 3-pin, straight, A-coded • Signal type: Sensor/actuator cable • Cable: 2 m, 3-wire, PUR, halogen-free • Description: Sensor/actuator cable, unshielded • Application: Zones with oils and lubricants, Drag chain operation, Robot 	YG8U13-020UA1M2A13	2095748

	Brief description	Type	Part no.
	<ul style="list-style-type: none"> • Connection type head A: Female connector, M8, 3-pin, straight, A-coded • Connection type head B: Male connector, M8, 3-pin, straight, A-coded • Signal type: Sensor/actuator cable • Cable: 2 m, 3-wire, PUR, halogen-free • Description: Sensor/actuator cable, unshielded • Application: Zones with oils and lubricants, Drag chain operation, Robot 	YF8U13-020UA1M8U13	2096304
	<ul style="list-style-type: none"> • Connection type head A: Female connector, M8, 3-pin, straight, A-coded • Connection type head B: Male connector, M8, 3-pin, straight, A-coded • Signal type: Sensor/actuator cable • Cable: 5 m, 3-wire, PUR, halogen-free • Description: Sensor/actuator cable, unshielded • Application: Zones with oils and lubricants, Drag chain operation, Robot 	YF8U13-050UA1M8U13	2096308
	<ul style="list-style-type: none"> • Connection type head A: Female connector, M8, 3-pin, angled, A-coded • Connection type head B: Male connector, M8, 3-pin, straight, A-coded • Signal type: Sensor/actuator cable • Cable: 2 m, 3-wire, PUR, halogen-free • Description: Sensor/actuator cable, unshielded • Application: Zones with oils and lubricants, Drag chain operation, Robot 	YG8U13-020UA1M8U13	2107781
	<ul style="list-style-type: none"> • Connection type head A: Female connector, M8, 3-pin, angled, A-coded • Connection type head B: Male connector, M12, 3-pin, straight, A-coded • Signal type: Sensor/actuator cable • Cable: 5 m, 3-wire, PUR, halogen-free • Description: Sensor/actuator cable, unshielded • Application: Zones with oils and lubricants, Drag chain operation, Robot 	YG8U13-050UA1M2A13	2122842
	<ul style="list-style-type: none"> • Connection type head A: Female connector, M8, 3-pin, straight, A-coded • Connection type head B: Male connector, M12, 3-pin, straight, A-coded • Signal type: Sensor/actuator cable • Cable: 3 m, 3-wire, PUR, halogen-free • Description: Sensor/actuator cable, unshielded • Application: Zones with oils and lubricants, Drag chain operation, Robot 	YF8U13-030UA1M2A13	2144589

SICK AT A GLANCE

SICK is one of the leading manufacturers of intelligent sensors and sensor solutions for industrial applications. A unique range of products and services creates the perfect basis for controlling processes securely and efficiently, protecting individuals from accidents and preventing damage to the environment.

We have extensive experience in a wide range of industries and understand their processes and requirements. With intelligent sensors, we can deliver exactly what our customers need. In application centers in Europe, Asia and North America, system solutions are tested and optimized in accordance with customer specifications. All this makes us a reliable supplier and development partner.

Comprehensive services complete our offering: SICK LifeTime Services provide support throughout the machine life cycle and ensure safety and productivity.

For us, that is “Sensor Intelligence.”

WORLDWIDE PRESENCE:

Contacts and other locations –www.sick.com