



# IM08-03BPS-VT1

IMI

**INDUCTIVE PROXIMITY SENSORS**

**SICK**  
Sensor Intelligence.



Illustration may differ



## Ordering information

Type	Part no.
IM08-03BPS-VT1	6068715

Other models and accessories → [www.sick.com/IMI](http://www.sick.com/IMI)

## Detailed technical data

### Features

<b>Housing</b>	Metric
<b>Thread size</b>	M8 x 1
<b>Diameter</b>	Ø 8 mm
<b>Pressure resistance</b>	≤ 100 bar
<b>Sensing range <math>S_n</math></b>	3 mm
<b>Safe sensing range <math>S_a</math></b>	2.43 mm
<b>Installation type</b>	Flush
<b>Switching frequency</b>	1,200 Hz
<b>Connection type</b>	Connector M8, 3-pin
<b>Switching output</b>	PNP
<b>Output function</b>	NO
<b>Electrical wiring</b>	DC 3-wire
<b>Enclosure rating</b>	IP68, IP69K <sup>1)</sup>
<b>Special features</b>	Sensing face made of stainless steel V2A, Resistant against coolant lubricants, triple sensing range, Visual adjustment indicator, IO-Link
<b>Special applications</b>	Zones with coolants and lubricants, Difficult application conditions
<b>Items supplied</b>	Mounting nut, V2A stainless steel (2x) Washer, V2A stainless steel, with locking teeth (2x)

<sup>1)</sup> According to EN 60529.

### Mechanics/electronics

<b>Supply voltage</b>	10 V DC ... 30 V DC
-----------------------	---------------------

<sup>1)</sup> Of  $V_S$ .

<sup>2)</sup> At  $I_a$  max.

<sup>3)</sup> Of  $S_r$ .

<sup>4)</sup> UB = 20 V DC ... 30 V DC, TA = 23 °C ± 5 °C.

<b>Ripple</b>	≤ 20 % <sup>1)</sup>
<b>Voltage drop</b>	≤ 2 V <sup>2)</sup>
<b>Time delay before availability</b>	≤ 10 ms
<b>Hysteresis</b>	1 % ... 20 %
<b>Reproducibility</b>	≤ 5 % <sup>3) 4)</sup>
<b>Temperature drift (of S<sub>r</sub>)</b>	≤ 10 %
<b>EMC</b>	According to EN 60947-5-2
<b>Continuous current I<sub>a</sub></b>	≤ 200 mA
<b>Short-circuit protection</b>	✓
<b>Power-up pulse protection</b>	✓
<b>Shock and vibration resistance</b>	30 g, 11 ms / 10 ... 55 Hz, 1 mm
<b>Ambient operating temperature</b>	-25 °C ... +85 °C
<b>Housing material</b>	Stainless steel V2A, DIN 1.4305 / AISI 303
<b>Sensing face material</b>	Stainless steel V2A, DIN 1.4305 / AISI 303
<b>Housing length</b>	60 mm
<b>Thread length</b>	45.5 mm
<b>Tightening torque, max.</b>	≤ 8 Nm
<b>Protection class</b>	III
<b>UL File No.</b>	E191603

<sup>1)</sup> Of V<sub>S</sub>.

<sup>2)</sup> At I<sub>a</sub> max.

<sup>3)</sup> Of S<sub>r</sub>.

<sup>4)</sup> U<sub>B</sub> = 20 V DC ... 30 V DC, T<sub>A</sub> = 23 °C ± 5 °C.

### Communication interface

<b>Communication interface</b>	IO-Link V1.0
<b>Communication Interface detail</b>	COM2 (38,4 kBaud)
<b>Process data length</b>	1 Byte
<b>Process data structure</b>	Bit 0 = S <sub>r</sub> reached
<b>Process data structure A</b>	Bit 1 = S <sub>a</sub> reached

### Reduction factors

<b>Note</b>	The values are reference values which may vary
<b>St37 steel (Fe)</b>	Approx. 1
<b>Stainless steel (V4A, 316L)</b>	Approx. 0.4 <sup>1)</sup>
<b>Aluminum (Al)</b>	Approx. 1
<b>Copper (Cu)</b>	Approx. 0.9
<b>Brass (Br)</b>	Approx. 1.3

<sup>1)</sup> Material thickness/Reduction factor: 1 mm/0.4 2 mm/0.8.

### Installation note

<b>Remark</b>	Associated graphic see "Installation"
<b>B</b>	14 mm

<b>C</b>	6 mm
<b>D</b>	6 mm
<b>F</b>	30 mm

Classifications

<b>ECLASS 5.0</b>	27270101
<b>ECLASS 5.1.4</b>	27270101
<b>ECLASS 6.0</b>	27270101
<b>ECLASS 6.2</b>	27270101
<b>ECLASS 7.0</b>	27270101
<b>ECLASS 8.0</b>	27270101
<b>ECLASS 8.1</b>	27270101
<b>ECLASS 9.0</b>	27270101
<b>ECLASS 10.0</b>	27270101
<b>ECLASS 11.0</b>	27270101
<b>ECLASS 12.0</b>	27274001
<b>ETIM 5.0</b>	EC002714
<b>ETIM 6.0</b>	EC002714
<b>ETIM 7.0</b>	EC002714
<b>ETIM 8.0</b>	EC002714
<b>UNSPSC 16.0901</b>	39122230

Installation note

Flush installation

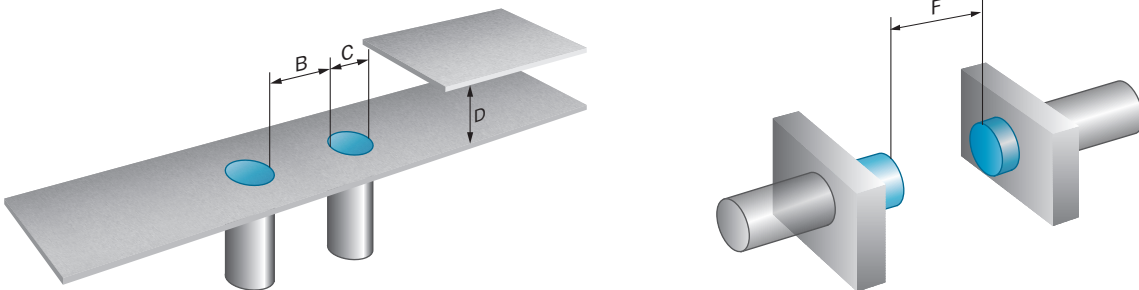

Connection diagram

Cd-453

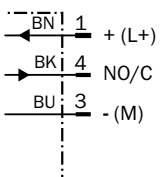

## Response diagram

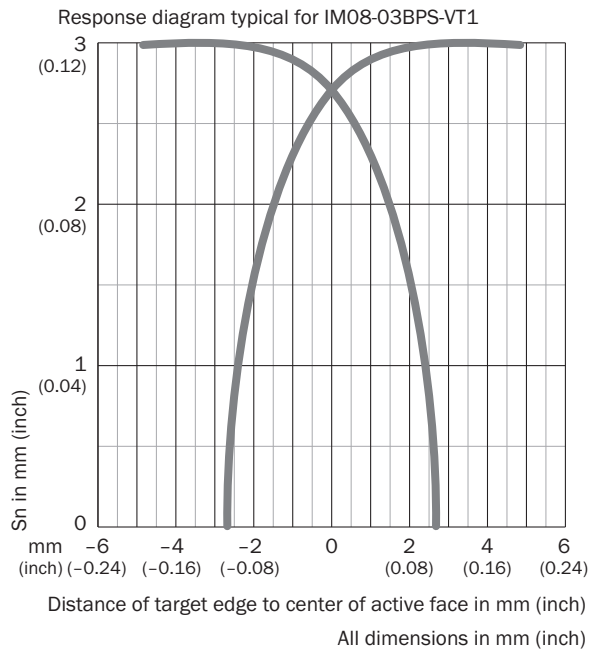

## Functional principle

### Installation aid

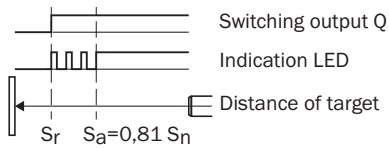

## Dimensional drawing (Dimensions in mm (inch))



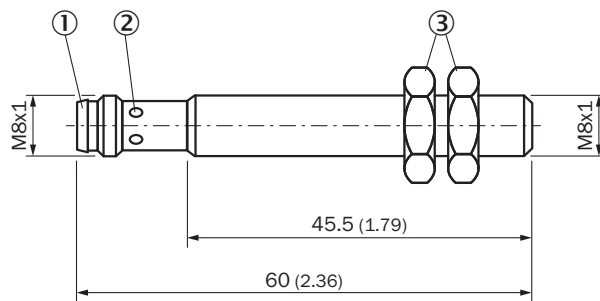



### IM08 Inox, flush



- ① Connection
- ② Display LED
- ③ Fastening nuts (2 x); width across 13, stainless steel V2A

Recommended accessories

Other models and accessories → [www.sick.com/IMI](http://www.sick.com/IMI)

	Brief description	Type	Part no.
Mounting brackets and plates			
	Mounting plate for M8 sensors, steel, zinc coated, without mounting hardware	BEF-WG-M08	5321722
	Mounting bracket for M8 sensors, steel, zinc coated, without mounting hardware	BEF-WN-M08	5321721
Others			
	<ul style="list-style-type: none"> <li>• <b>Connection type head A:</b> Female connector, M8, 3-pin, straight</li> <li>• <b>Connection type head B:</b> Flying leads</li> <li>• <b>Signal type:</b> Sensor/actuator cable</li> <li>• <b>Cable:</b> 2 m, 3-wire, PP</li> <li>• <b>Description:</b> Sensor/actuator cable, unshielded</li> <li>• <b>Connection systems:</b> Flying leads</li> <li>• <b>Note:</b> This product is generally resistant to chemical cleaning agents (see ECOLAB) and other chemical compounds such as H2O2 and CH2O2. Before permanent installation is carried out, the material's resistance to the cleaning agent being used must be checked., Resistant against lactic acid &amp; hydrogen peroxide (H2O2)</li> <li>• <b>Application:</b> Hygienic and washdown zones, Drag chain operation</li> </ul>	DOL-0803-G02MRN	6058504
	<ul style="list-style-type: none"> <li>• <b>Connection type head A:</b> Female connector, M8, 3-pin, straight</li> <li>• <b>Connection type head B:</b> Flying leads</li> <li>• <b>Signal type:</b> Sensor/actuator cable</li> <li>• <b>Cable:</b> 5 m, 3-wire, PP</li> <li>• <b>Description:</b> Sensor/actuator cable, unshielded</li> <li>• <b>Connection systems:</b> Flying leads</li> <li>• <b>Note:</b> This product is generally resistant to chemical cleaning agents (see ECOLAB) and other chemical compounds such as H2O2 and CH2O2. Before permanent installation is carried out, the material's resistance to the cleaning agent being used must be checked., Resistant against lactic acid &amp; hydrogen peroxide (H2O2)</li> <li>• <b>Application:</b> Hygienic and washdown zones, Drag chain operation</li> </ul>	DOL-0803-G05MRN	6058505
	<ul style="list-style-type: none"> <li>• <b>Connection type head A:</b> Female connector, M8, 3-pin, angled</li> <li>• <b>Connection type head B:</b> Flying leads</li> <li>• <b>Signal type:</b> Sensor/actuator cable</li> <li>• <b>Cable:</b> 2 m, 3-wire, PP</li> <li>• <b>Description:</b> Sensor/actuator cable, unshielded</li> <li>• <b>Connection systems:</b> Flying leads</li> <li>• <b>Note:</b> This product is generally resistant to chemical cleaning agents (see ECOLAB) and other chemical compounds such as H2O2 and CH2O2. Before permanent installation is carried out, the material's resistance to the cleaning agent being used must be checked., Resistant against lactic acid &amp; hydrogen peroxide (H2O2)</li> <li>• <b>Application:</b> Hygienic and washdown zones, Drag chain operation</li> </ul>	DOL-0803-W02MRN	6058507
	<ul style="list-style-type: none"> <li>• <b>Connection type head A:</b> Female connector, M8, 3-pin, angled</li> <li>• <b>Connection type head B:</b> Flying leads</li> <li>• <b>Signal type:</b> Sensor/actuator cable</li> <li>• <b>Cable:</b> 5 m, 3-wire, PP</li> <li>• <b>Description:</b> Sensor/actuator cable, unshielded</li> <li>• <b>Connection systems:</b> Flying leads</li> <li>• <b>Note:</b> This product is generally resistant to chemical cleaning agents (see ECOLAB) and other chemical compounds such as H2O2 and CH2O2. Before permanent installation is carried out, the material's resistance to the cleaning agent being used must be checked.</li> <li>• <b>Application:</b> Hygienic and washdown zones, Drag chain operation</li> </ul>	DOL-0803-W05MRN	6058508

	Brief description	Type	Part no.
	<ul style="list-style-type: none"> <li>• <b>Connection type head A:</b> Female connector, M8, 3-pin, angled</li> <li>• <b>Connection type head B:</b> Flying leads</li> <li>• <b>Signal type:</b> Sensor/actuator cable</li> <li>• <b>Cable:</b> 2 m, 3-wire, PP</li> <li>• <b>Description:</b> Sensor/actuator cable, unshielded, LED function display</li> <li>• <b>Connection systems:</b> Flying leads</li> <li>• <b>Note:</b> This product is generally resistant to chemical cleaning agents (see ECOLAB) and other chemical compounds such as H2O2 and CH2O2. Before permanent installation is carried out, the material's resistance to the cleaning agent being used must be checked., Resistant against lactic acid &amp; hydrogen peroxide (H2O2), only suitable for PNP sensors</li> <li>• <b>Application:</b> Hygienic and washdown zones, Drag chain operation</li> </ul>	DOL-0803-L02MRN	6058787
	<ul style="list-style-type: none"> <li>• <b>Connection type head A:</b> Female connector, M8, 3-pin, angled</li> <li>• <b>Connection type head B:</b> Flying leads</li> <li>• <b>Signal type:</b> Sensor/actuator cable</li> <li>• <b>Cable:</b> 5 m, 3-wire, PP</li> <li>• <b>Description:</b> Sensor/actuator cable, unshielded, LED function display</li> <li>• <b>Connection systems:</b> Flying leads</li> <li>• <b>Note:</b> This product is generally resistant to chemical cleaning agents (see ECOLAB) and other chemical compounds such as H2O2 and CH2O2. Before permanent installation is carried out, the material's resistance to the cleaning agent being used must be checked.</li> <li>• <b>Application:</b> Hygienic and washdown zones, Drag chain operation</li> </ul>	DOL-0803-L05MRN	6058788
	<ul style="list-style-type: none"> <li>• <b>Connection type head A:</b> Female connector, M8, 3-pin, straight, A-coded</li> <li>• <b>Connection type head B:</b> Flying leads</li> <li>• <b>Signal type:</b> Sensor/actuator cable</li> <li>• <b>Cable:</b> 2 m, 3-wire, PUR, halogen-free</li> <li>• <b>Description:</b> Sensor/actuator cable, unshielded</li> <li>• <b>Application:</b> Zones with oils and lubricants, Drag chain operation, Robot</li> </ul>	YF8U13-020UA1XLEAX	2094782
	<ul style="list-style-type: none"> <li>• <b>Connection type head A:</b> Female connector, M8, 3-pin, angled, A-coded</li> <li>• <b>Connection type head B:</b> Flying leads</li> <li>• <b>Signal type:</b> Sensor/actuator cable</li> <li>• <b>Cable:</b> 2 m, 3-wire, PUR, halogen-free</li> <li>• <b>Description:</b> Sensor/actuator cable, unshielded</li> <li>• <b>Application:</b> Zones with oils and lubricants, Drag chain operation, Robot</li> </ul>	YG8U13-020UA1XLEAX	2094794
	<ul style="list-style-type: none"> <li>• <b>Connection type head A:</b> Female connector, M8, 3-pin, angled, A-coded</li> <li>• <b>Connection type head B:</b> Flying leads</li> <li>• <b>Signal type:</b> Sensor/actuator cable</li> <li>• <b>Cable:</b> 2 m, 3-wire, PUR, halogen-free</li> <li>• <b>Description:</b> Sensor/actuator cable, unshielded, LED function display</li> <li>• <b>Note:</b> Only suitable for PNP sensors</li> <li>• <b>Application:</b> Zones with oils and lubricants, Drag chain operation, Robot</li> </ul>	YI8U13-020UA1XLEAX	2095593
	<ul style="list-style-type: none"> <li>• <b>Connection type head A:</b> Female connector, M8, 3-pin, straight, A-coded</li> <li>• <b>Connection type head B:</b> Male connector, M8, 3-pin, straight, A-coded</li> <li>• <b>Signal type:</b> Sensor/actuator cable</li> <li>• <b>Cable:</b> 2 m, 3-wire, PUR, halogen-free</li> <li>• <b>Description:</b> Sensor/actuator cable, unshielded</li> <li>• <b>Application:</b> Zones with oils and lubricants, Drag chain operation, Robot</li> </ul>	YF8U13-020UA1M8U13	2096304
	<ul style="list-style-type: none"> <li>• <b>Connection type head A:</b> Female connector, M8, 3-pin, straight, A-coded</li> <li>• <b>Connection type head B:</b> Male connector, M8, 3-pin, straight, A-coded</li> <li>• <b>Signal type:</b> Sensor/actuator cable</li> <li>• <b>Cable:</b> 5 m, 3-wire, PUR, halogen-free</li> <li>• <b>Description:</b> Sensor/actuator cable, unshielded</li> <li>• <b>Application:</b> Zones with oils and lubricants, Drag chain operation, Robot</li> </ul>	YF8U13-050UA1M8U13	2096308

## Recommended services

Additional services → [www.sick.com/IMI](https://www.sick.com/IMI)

	Type	Part no.
Function Block Factory		
<ul style="list-style-type: none"><li>• <b>Description:</b> The Function Block Factory supports common programmable logic controllers (PLCs) from various manufacturers, such as Siemens, Beckhoff, Rockwell Automation and B&amp;R. More information on the FBF can be found <a _blank"="" href="https://fbf.cloud.sick.com target=">here</a>.</li><li>• <b>Note:</b> You can configure your function block at <a _blank"="" href="https://fbf.cloud.sick.com target=">Function Block Factory</a>. As a login please use your SICK ID.</li></ul>	Function Block Factory	On request



## SICK AT A GLANCE

SICK is one of the leading manufacturers of intelligent sensors and sensor solutions for industrial applications. A unique range of products and services creates the perfect basis for controlling processes securely and efficiently, protecting individuals from accidents and preventing damage to the environment.

We have extensive experience in a wide range of industries and understand their processes and requirements. With intelligent sensors, we can deliver exactly what our customers need. In application centers in Europe, Asia and North America, system solutions are tested and optimized in accordance with customer specifications. All this makes us a reliable supplier and development partner.

Comprehensive services complete our offering: SICK LifeTime Services provide support throughout the machine life cycle and ensure safety and productivity.

For us, that is “Sensor Intelligence.”

## WORLDWIDE PRESENCE:

Contacts and other locations –[www.sick.com](http://www.sick.com)