



IM12-02B-N-ZW0

IMN

INDUCTIVE PROXIMITY SENSORS

SICK
Sensor Intelligence.

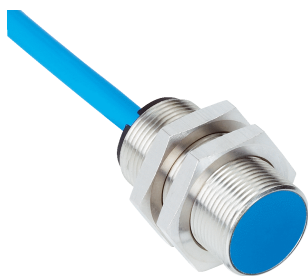

Ordering information

Type	Part no.
IM12-02B-N-ZW0	6021124

Included in delivery: BEF-MU-M12 (1)

Other models and accessories → www.sick.com/IMN

Illustration may differ



Detailed technical data

Features

Housing	Metric
Thread size	M12 x 1
Diameter	Ø 12 mm
Sensing range S_n	2 mm
Safe sensing range S_a	1.62 mm
Installation type	Flush
Switching frequency	1,200 Hz
Connection type	Cable, 2-wire, 2 m
Switching output	NAMUR
Output function	NC
Enclosure rating	IP67 ¹⁾
Special applications	Explosive areas
Items supplied	Mounting nut, brass, nickel-plated (2x)

¹⁾ According to EN 60529.

Mechanics/electronics

Supply voltage	7.5 V DC ... 25 V DC ¹⁾
Hysteresis	1 % ... 15 %
Temperature drift (of S_n)	± 10 %
EMC	According to EN 60947-5-6
Current consumption, sensor is activated	≤ 1 mA
Current consumption, sensor is not activated	≥ 2.2 mA
Cable material	PVC

¹⁾ When used outside the hazardous area.

²⁾ For connection to a separately certified intrinsically safe circuit only.

³⁾ 1 kΩ.

Conductor size	0.34 mm ²
Cable diameter	Ø 4.9 mm
Cable resistance	50 Ω
Shock and vibration resistance	30 g, 11 ms / 10 ... 55 Hz, 1 mm
Ambient operating temperature	-20 °C ... +70 °C
Housing material	Brass, nickel-plated
Sensing face material	Plastic, PTB
Housing length	30 mm
Thread length	29 mm
Tightening torque, max.	7 Nm
Weight	+ 130 g
Type approval certificate	PTB 03 ATEX 2037
Ex area category	1G
Input voltage U_i max.	15 V ²⁾
Input power P_i max.	120 mW ²⁾
Input current I_i max.	50 mA ²⁾
Internal capacitance C_i max.	140 nF ²⁾
Internal inductance L_i max.	340 µH ²⁾
Nominal voltage	8.2 V DC ³⁾
Device labeling	II 1G Ex ia IIC T6 Ga Ta -20 °C ... +70 °C

¹⁾ When used outside the hazardous area.

²⁾ For connection to a separately certified intrinsically safe circuit only.

³⁾ 1 kΩ.

Safety-related parameters

MTTF_D	7,577 years
DC_{avg}	0%
T_M (mission time)	20 years

Reduction factors

Note	The values are reference values which may vary
Stainless steel (V2A, 304)	Approx. 0.7
Aluminum (Al)	Approx. 0.4
Copper (Cu)	Approx. 0.3
Brass (Br)	Approx. 0.5

Installation note

Remark	Associated graphic see "Installation"
B	12 mm
C	12 mm
D	6 mm
F	16 mm

Classifications

ECLASS 5.0	27270101
ECLASS 5.1.4	27270101
ECLASS 6.0	27270101
ECLASS 6.2	27270101
ECLASS 7.0	27270101
ECLASS 8.0	27270101
ECLASS 8.1	27270101
ECLASS 9.0	27270101
ECLASS 10.0	27270101
ECLASS 11.0	27270101
ECLASS 12.0	27274001
ETIM 5.0	EC002714
ETIM 6.0	EC002714
ETIM 7.0	EC002714
ETIM 8.0	EC002714
UNSPSC 16.0901	39122230

Installation note

Flush installation

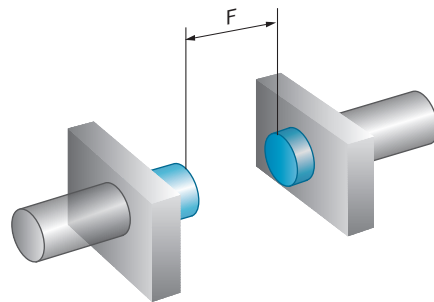
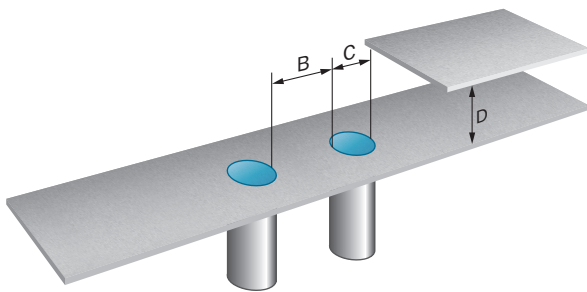

Connection type

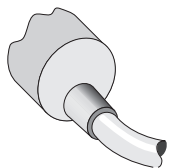

Connection diagram

Cd-012

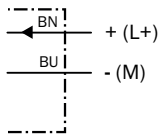

Dimensional drawing (Dimensions in mm (inch))



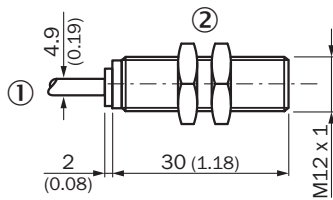

IM12 Namur, flush



- ① Connection
- ② Fastening nuts (2x); width across 17, metal

Recommended accessories

Other models and accessories → www.sick.com/IMN

	Brief description	Type	Part no.
Power supply modules			
	NAMUR isolating amplifier, Cable fault detection, Switching outputs: 2 NO relay (1 per channel), Supply voltage: 24 V ... 230 V, Voltage type: AC/DC	EN2-2EX1	6041096
Universal bar clamp systems			
	Plate N05 for universal clamp bracket, M12, Zinc plated steel (sheet), Zinc die cast (clamping bracket), Universal clamp (5322626), mounting hardware	BEF-KHS-N05	2051611
Mounting brackets and plates			
	Mounting plate for M12 sensors, steel, zinc coated, without mounting hardware	BEF-WG-M12	5321869
	Mounting bracket for M12 sensors, steel, zinc coated, without mounting hardware	BEF-WN-M12	5308447

SICK AT A GLANCE

SICK is one of the leading manufacturers of intelligent sensors and sensor solutions for industrial applications. A unique range of products and services creates the perfect basis for controlling processes securely and efficiently, protecting individuals from accidents and preventing damage to the environment.

We have extensive experience in a wide range of industries and understand their processes and requirements. With intelligent sensors, we can deliver exactly what our customers need. In application centers in Europe, Asia and North America, system solutions are tested and optimized in accordance with customer specifications. All this makes us a reliable supplier and development partner.

Comprehensive services complete our offering: SICK LifeTime Services provide support throughout the machine life cycle and ensure safety and productivity.

For us, that is “Sensor Intelligence.”

WORLDWIDE PRESENCE:

Contacts and other locations –www.sick.com