



# IMA18-08NE1ZW2S

IMA

INDUCTIVE PROXIMITY SENSORS

**SICK**  
Sensor Intelligence.



### Ordering information

Type	Part no.
IMA18-08NE1ZW2S	1105020

Other models and accessories → [www.sick.com/IMA](http://www.sick.com/IMA)

Illustration may differ



### Detailed technical data

#### Features

<b>Housing</b>	Metric
<b>Thread size</b>	M18 x 1
<b>Diameter</b>	Ø 18 mm
<b>Sensing range <math>S_n</math></b>	0 mm ... 8 mm
<b>Installation type</b>	Non-flush
<b>Connection type</b>	Cable, 4-wire, 2 m
<b>Output function</b>	Analog
<b>Repeatability (<math>T_a</math> not constant)</b>	0.3 mm <sup>1) 2) 3)</sup>
<b>Repeatability (<math>T_a</math> constant)</b>	± 0.1 mm
<b>Enclosure rating</b>	IP67 <sup>4)</sup>
<b>Special features</b>	Analog output
<b>Items supplied</b>	Mounting nut, brass, chromium-plated (2x)

<sup>1)</sup> As per IEC 60947-5-2.

<sup>2)</sup>  $U_b = DC 20 V \dots 30 V$ .

<sup>3)</sup>  $T_A = 23 \text{ °C} \pm 5 \text{ °C}$ .

<sup>4)</sup> According to EN 60529: 2000-09.

#### Mechanics/electronics

<b>Supply voltage</b>	15 V DC ... 30 V DC
<b>Ripple</b>	≤ 20 % <sup>1)</sup>
<b>Time delay before availability</b>	≤ 30 ms
<b>Temperature drift (of <math>S_n</math>)</b>	≤ 10 %

<sup>1)</sup> Of  $V_S$ .

<sup>2)</sup> Without load.

<sup>3)</sup> -3 dB if  $S_n = 4 \text{ mm}$ .

<sup>4)</sup> QA1 loaded, QA2 unloaded.

<sup>5)</sup> QA1 loaded, QA2 loaded: see temperature reduction.

<b>No load current</b>	$\leq 12 \text{ mA}^{2)}$
<b>Max. load resistance on Q<sub>A1</sub></b>	$\geq 2 \text{ k}\Omega$
<b>Max. load resistance on Q<sub>A2</sub></b>	$400 \Omega \text{ Ub} = 15 \text{ V}$
<b>Output voltage Q<sub>A1</sub></b>	s = 0 mm: 0 V -0/+0,6 V (23 °C) s = 4 mm: 5,6 V +/-0,6 V (23 °C) s = 8 mm: 10 V +/-0,6 V (23 °C)
<b>Output current Q<sub>A2</sub></b>	s = 0 mm: 4 mA +/-0,8 mA (23 °C) s = 8 mm: 20 mA +/-0,8 mA (23 °C)
<b>Output voltage</b>	0 V ... 10 V
<b>Output current</b>	4 mA ... 20 mA
<b>Bandwidth</b>	500 Hz <sup>3)</sup>
<b>Short-circuit protection</b>	✓
<b>Ambient operating temperature</b>	-25 °C ... +70 °C <sup>4) 5)</sup>
<b>Housing material</b>	Brass, chromium-plated
<b>Sensing face material</b>	Plastic
<b>Housing length</b>	67 mm
<b>Thread length</b>	42 mm

1) Of V<sub>S</sub>.

2) Without load.

3) -3 dB if S<sub>n</sub> = 4 mm.

4) QA1 loaded, QA2 unloaded.

5) QA1 loaded, QA2 loaded: see temperature reduction.

### Safety-related parameters

<b>MTTF<sub>D</sub></b>	1,149 years
<b>DC<sub>avg</sub></b>	0 %
<b>T<sub>M</sub> (mission time)</b>	20 years

### Installation note

<b>Remark</b>	Associated graphic see "Installation"
<b>A</b>	18 mm
<b>B</b>	36 mm
<b>C</b>	18 mm
<b>D</b>	24 mm
<b>E</b>	16 mm
<b>F</b>	64 mm

### Classifications

<b>ECLASS 5.0</b>	27270101
<b>ECLASS 5.1.4</b>	27270101
<b>ECLASS 6.0</b>	27270101
<b>ECLASS 6.2</b>	27270101
<b>ECLASS 7.0</b>	27270101
<b>ECLASS 8.0</b>	27270101
<b>ECLASS 8.1</b>	27270101

<b>ECLASS 9.0</b>	27270101
<b>ECLASS 10.0</b>	27270101
<b>ECLASS 11.0</b>	27270101
<b>ECLASS 12.0</b>	27274001
<b>ETIM 5.0</b>	EC002714
<b>ETIM 6.0</b>	EC002714
<b>ETIM 7.0</b>	EC002714
<b>ETIM 8.0</b>	EC002714
<b>UNSPSC 16.0901</b>	39122230

### Installation note

Non-flush installation

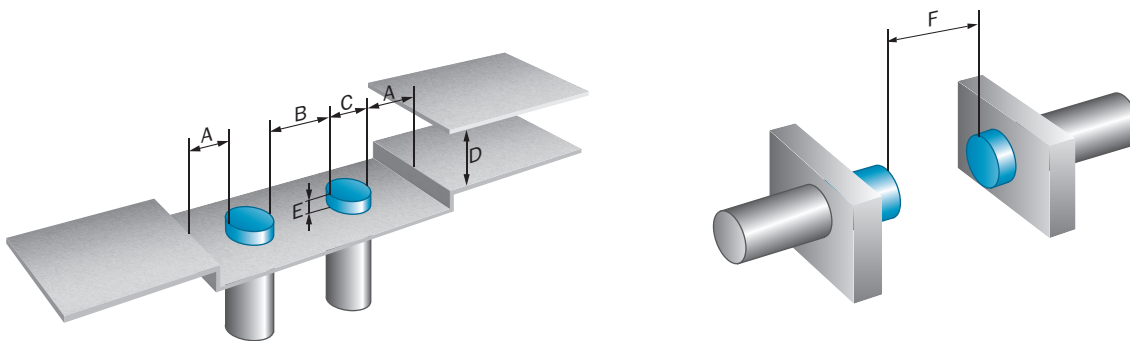

### Connection diagram

Cd-022

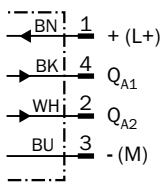

Temperature derating

Temperature derating

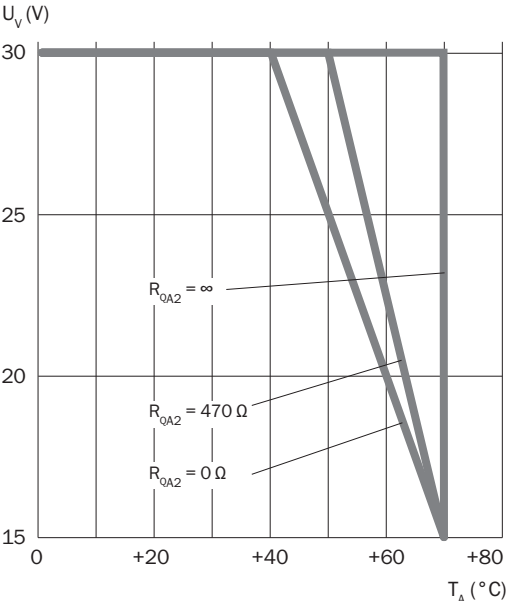

Response diagram

Reduction factors

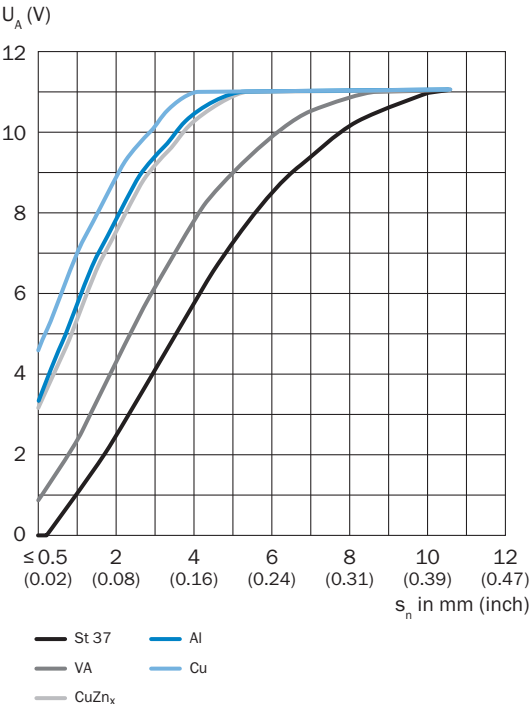

Output current

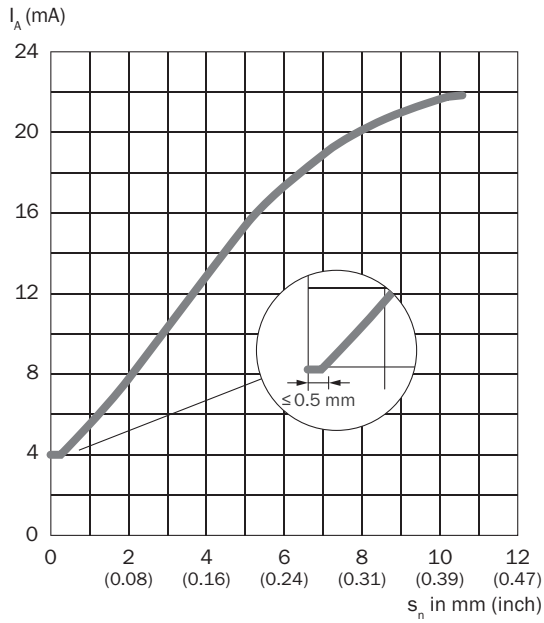

Output voltage

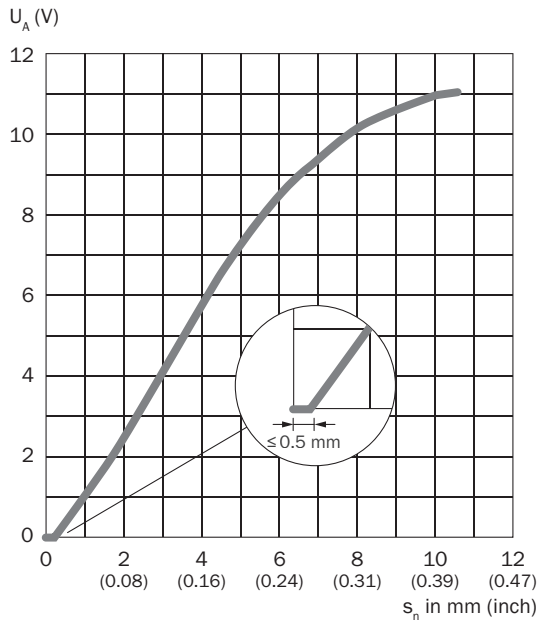

### Dimensional drawing (Dimensions in mm (inch))



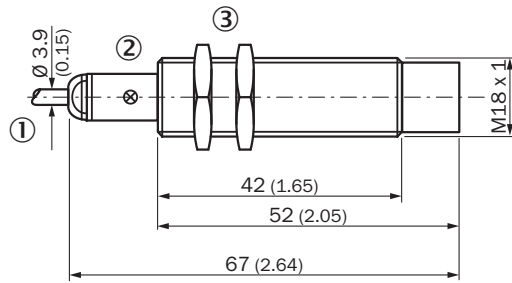



IMA18 Standard, cable, non-flush





- ① Connection
- ② Display LED
- ③ Fastening nuts (2x); width across 24, metal

### Recommended accessories

Other models and accessories → [www.sick.com/IMA](http://www.sick.com/IMA)

	Brief description	Type	Part no.
<b>Universal bar clamp systems</b>			
	Plate N06 for universal clamp bracket, M18, Zinc plated steel (sheet), Zinc die cast (clamping bracket), Universal clamp (5322626), mounting hardware	BEF-KHS-N06	2051612
<b>Mounting brackets and plates</b>			
	Mounting bracket for M18 sensors, steel, zinc coated, without mounting hardware	BEF-WN-M18	5308446
<b>Terminal and alignment brackets</b>			
	Mounting bracket with ball-and-socket, plastic, mounting hardware included	BEF-WN-M18-ST02	5312973
	Clamping block for round sensors M18, without fixed stop, plastic (PA12), glass-fiber reinforced, mounting hardware included	BEF-KH-M18	2051481
	Clamping block for round sensors M18, with fixed stop, plastic (PA12), glass-fiber reinforced, mounting hardware included	BEF-KHF-M18	2051482
<b>Others</b>			
	<ul style="list-style-type: none"> <li>• <b>Connection type head A:</b> Female connector, M12, 4-pin, straight, A-coded</li> <li>• <b>Connection type head B:</b> Flying leads</li> <li>• <b>Signal type:</b> Sensor/actuator cable</li> <li>• <b>Cable:</b> 2 m, 4-wire, PVC</li> <li>• <b>Description:</b> Sensor/actuator cable, unshielded</li> <li>• <b>Application:</b> Zones with chemicals</li> </ul>	YF2A14-020VB3XLEAX	2096234
	<ul style="list-style-type: none"> <li>• <b>Connection type head A:</b> Female connector, M12, 4-pin, straight, A-coded</li> <li>• <b>Connection type head B:</b> Flying leads</li> <li>• <b>Signal type:</b> Sensor/actuator cable</li> <li>• <b>Cable:</b> 5 m, 4-wire, PVC</li> <li>• <b>Description:</b> Sensor/actuator cable, unshielded</li> <li>• <b>Application:</b> Zones with chemicals</li> </ul>	YF2A14-050VB3XLEAX	2096235

	Brief description	Type	Part no.
	<ul style="list-style-type: none"> <li>• <b>Connection type head A:</b> Female connector, M12, 4-pin, angled, A-coded</li> <li>• <b>Connection type head B:</b> Flying leads</li> <li>• <b>Signal type:</b> Sensor/actuator cable</li> <li>• <b>Cable:</b> 2 m, 4-wire, PVC</li> <li>• <b>Description:</b> Sensor/actuator cable, unshielded</li> <li>• <b>Application:</b> Zones with chemicals</li> </ul>	YG2A14-020VB3XLEAX	2095895
	<ul style="list-style-type: none"> <li>• <b>Connection type head A:</b> Female connector, M12, 4-pin, angled, A-coded</li> <li>• <b>Connection type head B:</b> Flying leads</li> <li>• <b>Signal type:</b> Sensor/actuator cable</li> <li>• <b>Cable:</b> 5 m, 4-wire, PVC</li> <li>• <b>Description:</b> Sensor/actuator cable, unshielded</li> <li>• <b>Application:</b> Zones with chemicals</li> </ul>	YG2A14-050VB3XLEAX	2095897



## SICK AT A GLANCE

SICK is one of the leading manufacturers of intelligent sensors and sensor solutions for industrial applications. A unique range of products and services creates the perfect basis for controlling processes securely and efficiently, protecting individuals from accidents and preventing damage to the environment.

We have extensive experience in a wide range of industries and understand their processes and requirements. With intelligent sensors, we can deliver exactly what our customers need. In application centers in Europe, Asia and North America, system solutions are tested and optimized in accordance with customer specifications. All this makes us a reliable supplier and development partner.

Comprehensive services complete our offering: SICK LifeTime Services provide support throughout the machine life cycle and ensure safety and productivity.

For us, that is “Sensor Intelligence.”

## WORLDWIDE PRESENCE:

Contacts and other locations –[www.sick.com](http://www.sick.com)