



# IMA30-15NE1ZC0S

IMA

**INDUCTIVE PROXIMITY SENSORS**

**SICK**  
Sensor Intelligence.



Illustration may differ



## Ordering information

Type	Part no.
IMA30-15NE1ZCOS	1107307

Other models and accessories → [www.sick.com/IMA](http://www.sick.com/IMA)

## Detailed technical data

### Features

<b>Housing</b>	Metric
<b>Thread size</b>	M30 x 1.5
<b>Diameter</b>	Ø 30 mm
<b>Sensing range <math>S_n</math></b>	0 mm ... 15 mm
<b>Installation type</b>	Non-flush
<b>Connection type</b>	Male connector M12, 4-pin
<b>Output function</b>	Analog
<b>Repeatability (<math>T_a</math> not constant)</b>	0.3 mm <sup>1) 2) 3)</sup>
<b>Repeatability (<math>T_a</math> constant)</b>	± 0.1 mm
<b>Enclosure rating</b>	IP67 <sup>4)</sup>
<b>Special features</b>	Analog output
<b>Items supplied</b>	Mounting nut, brass, nickel-plated (2x)

<sup>1)</sup> As per IEC 60947-5-2.

<sup>2)</sup>  $U_b = DC\ 20\ V \dots 30\ V$ .

<sup>3)</sup>  $T_A = 23\ ^\circ C \pm 5\ ^\circ C$ .

<sup>4)</sup> According to EN 60529: 2000-09.

### Mechanics/electronics

<b>Supply voltage</b>	15 V DC ... 30 V DC
<b>Ripple</b>	≤ 20 % <sup>1)</sup>
<b>Time delay before availability</b>	≤ 30 ms
<b>Temperature drift (of <math>S_n</math>)</b>	≤ 10 %

<sup>1)</sup> Of  $V_S$ .

<sup>2)</sup> Without load.

<sup>3)</sup> -3 dB if  $S_n = 7.5\ mm$ .

<sup>4)</sup> QA1 loaded, QA2 unloaded.

<sup>5)</sup> QA1 loaded, QA2 loaded: see temperature reduction.

<b>No load current</b>	$\leq 12 \text{ mA}^{2)}$
<b>Max. load resistance on Q<sub>A1</sub></b>	$\geq 2 \text{ k}\Omega$
<b>Max. load resistance on Q<sub>A2</sub></b>	$400 \Omega \text{ Ub} = 15 \text{ V}$
<b>Output voltage Q<sub>A1</sub></b>	s = 0 mm: 0 V -0/+0,6 V (23 °C) s = 7,5 mm: 6,2 V +/-0,6 V (23 °C) s = 15 mm: 10 V +/-0,6 V (23 °C)
<b>Output current Q<sub>A2</sub></b>	s = 0 mm: 4 mA +/-0,8 mA (23 °C) s = 15 mm: 20 mA +/-0,8 mA (23 °C)
<b>Output voltage</b>	0 V ... 10 V
<b>Output current</b>	4 mA ... 20 mA
<b>Bandwidth</b>	500 Hz <sup>3)</sup>
<b>Short-circuit protection</b>	✓
<b>Ambient operating temperature</b>	-25 °C ... +70 °C <sup>4) 5)</sup>
<b>Housing material</b>	Brass, chromium-plated
<b>Sensing face material</b>	Plastic
<b>Housing length</b>	71 mm
<b>Thread length</b>	41 mm

1) Of V<sub>S</sub>.

2) Without load.

3) -3 dB if S<sub>n</sub> = 7.5 mm.

4) QA1 loaded, QA2 unloaded.

5) QA1 loaded, QA2 loaded: see temperature reduction.

### Safety-related parameters

<b>MTTF<sub>D</sub></b>	1,149 years
<b>DC<sub>avg</sub></b>	0 %
<b>T<sub>M</sub> (mission time)</b>	20 years

### Installation note

<b>Remark</b>	Associated graphic see "Installation"
<b>A</b>	30 mm
<b>B</b>	60 mm
<b>C</b>	30 mm
<b>D</b>	45 mm
<b>E</b>	30 mm
<b>F</b>	120 mm

### Classifications

<b>ECLASS 5.0</b>	27270101
<b>ECLASS 5.1.4</b>	27270101
<b>ECLASS 6.0</b>	27270101
<b>ECLASS 6.2</b>	27270101
<b>ECLASS 7.0</b>	27270101
<b>ECLASS 8.0</b>	27270101
<b>ECLASS 8.1</b>	27270101

<b>ECLASS 9.0</b>	27270101
<b>ECLASS 10.0</b>	27270101
<b>ECLASS 11.0</b>	27270101
<b>ECLASS 12.0</b>	27274001
<b>ETIM 5.0</b>	EC002714
<b>ETIM 6.0</b>	EC002714
<b>ETIM 7.0</b>	EC002714
<b>ETIM 8.0</b>	EC002714
<b>UNSPSC 16.0901</b>	39122230

### Installation note

Non-flush installation

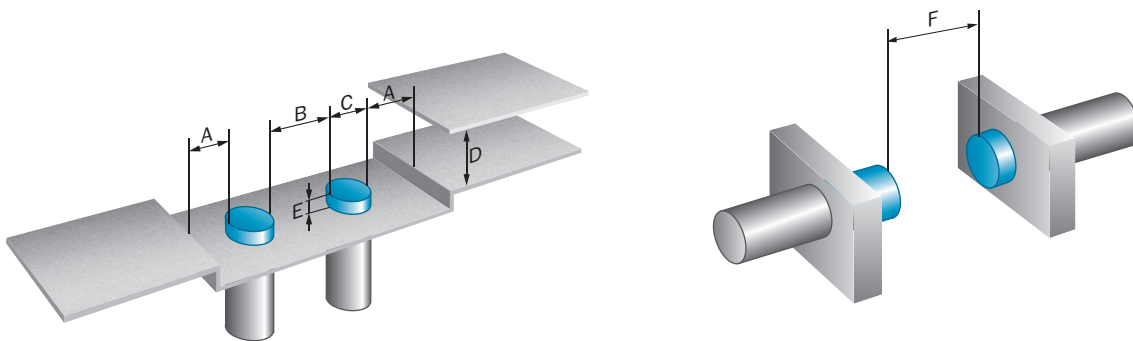

### Connection type

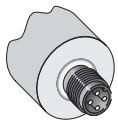

### Connection diagram

Cd-022

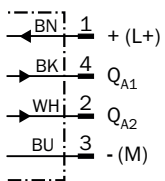

## Temperature derating

Temperature derating

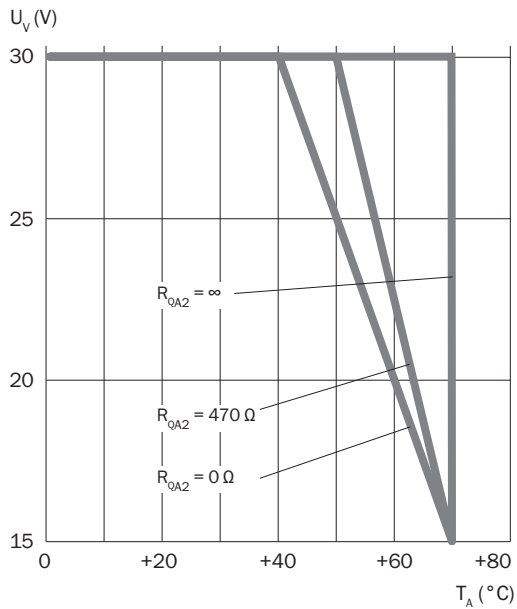

## Response diagram

Reduction factors

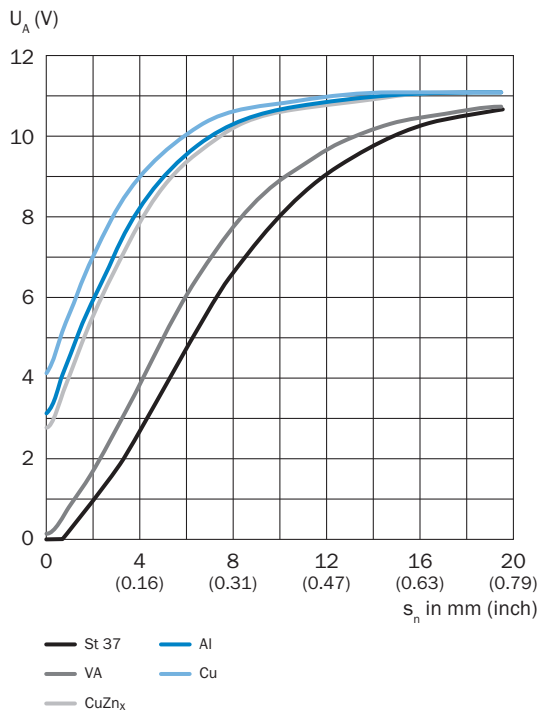

Output current

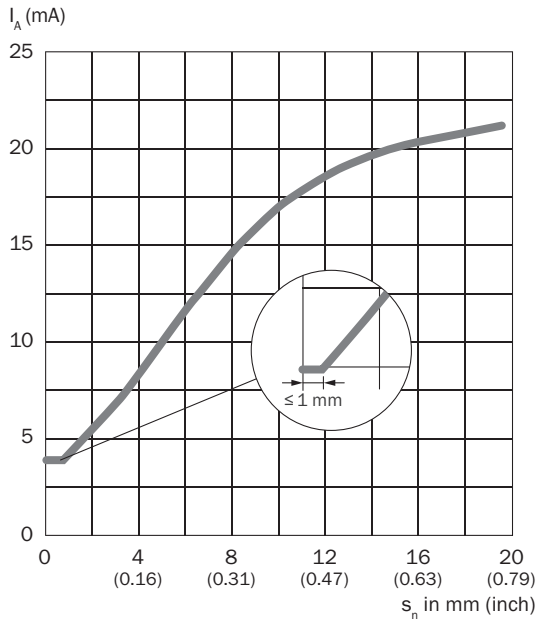

Output voltage

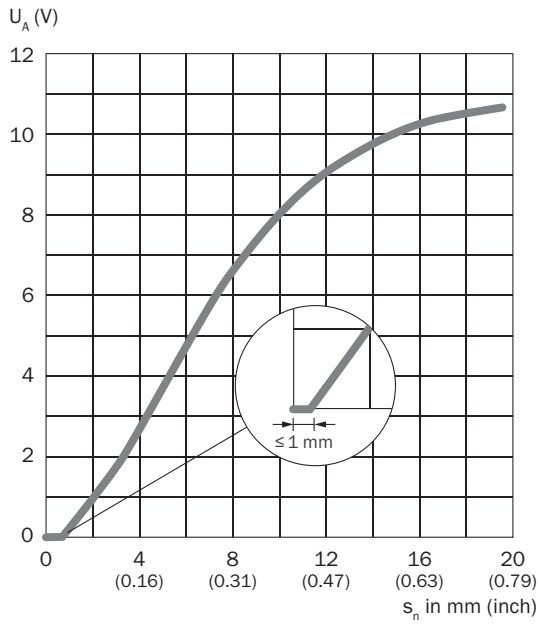

Dimensional drawing (Dimensions in mm (inch))

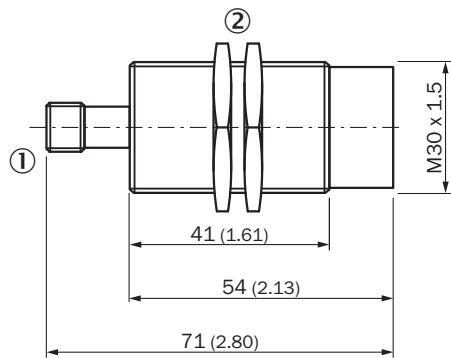

IMA30, connector, non-flush







- ① Connection
- ② Fastening nuts (2x); width across 36, metal

Recommended accessories

Other models and accessories → [www.sick.com/IMA](http://www.sick.com/IMA)

	Brief description	Type	Part no.
<b>Mounting brackets and plates</b>			
	Mounting plate for M30 sensors, steel, zinc coated, without mounting hardware	BEF-WG-M30	5321871
	Mounting bracket for M30 sensors, steel, zinc coated, without mounting hardware	BEF-WN-M30	5308445
<b>Others</b>			
	<ul style="list-style-type: none"> <li>• <b>Connection type head A:</b> Female connector, M12, 4-pin, straight, A-coded</li> <li>• <b>Connection type head B:</b> Flying leads</li> <li>• <b>Signal type:</b> Sensor/actuator cable</li> <li>• <b>Cable:</b> 2 m, 4-wire, PVC</li> <li>• <b>Description:</b> Sensor/actuator cable, unshielded</li> <li>• <b>Application:</b> Zones with chemicals</li> </ul>	YF2A14-020VB3XLEAX	2096234
	<ul style="list-style-type: none"> <li>• <b>Connection type head A:</b> Female connector, M12, 4-pin, straight, A-coded</li> <li>• <b>Connection type head B:</b> Flying leads</li> <li>• <b>Signal type:</b> Sensor/actuator cable</li> <li>• <b>Cable:</b> 5 m, 4-wire, PVC</li> <li>• <b>Description:</b> Sensor/actuator cable, unshielded</li> <li>• <b>Application:</b> Zones with chemicals</li> </ul>	YF2A14-050VB3XLEAX	2096235
	<ul style="list-style-type: none"> <li>• <b>Connection type head A:</b> Female connector, M12, 4-pin, angled, A-coded</li> <li>• <b>Connection type head B:</b> Flying leads</li> <li>• <b>Signal type:</b> Sensor/actuator cable</li> <li>• <b>Cable:</b> 2 m, 4-wire, PVC</li> <li>• <b>Description:</b> Sensor/actuator cable, unshielded</li> <li>• <b>Application:</b> Zones with chemicals</li> </ul>	YG2A14-020VB3XLEAX	2095895
	<ul style="list-style-type: none"> <li>• <b>Connection type head A:</b> Female connector, M12, 4-pin, angled, A-coded</li> <li>• <b>Connection type head B:</b> Flying leads</li> <li>• <b>Signal type:</b> Sensor/actuator cable</li> <li>• <b>Cable:</b> 5 m, 4-wire, PVC</li> <li>• <b>Description:</b> Sensor/actuator cable, unshielded</li> <li>• <b>Application:</b> Zones with chemicals</li> </ul>	YG2A14-050VB3XLEAX	2095897

	Brief description	Type	Part no.
	<ul style="list-style-type: none"> <li>• <b>Connection type head A:</b> Female connector, M12, 4-pin, straight, A-coded</li> <li>• <b>Connection type head B:</b> Flying leads</li> <li>• <b>Signal type:</b> Sensor/actuator cable</li> <li>• <b>Cable:</b> 2 m, 4-wire, PUR, halogen-free</li> <li>• <b>Description:</b> Sensor/actuator cable, unshielded</li> <li>• <b>Application:</b> Zones with oils and lubricants, Drag chain operation, Robot</li> </ul>	YF2A14-020UB3XLEAX	2095607
	<ul style="list-style-type: none"> <li>• <b>Connection type head A:</b> Female connector, M12, 4-pin, straight, A-coded</li> <li>• <b>Connection type head B:</b> Flying leads</li> <li>• <b>Signal type:</b> Sensor/actuator cable</li> <li>• <b>Cable:</b> 5 m, 4-wire, PUR, halogen-free</li> <li>• <b>Description:</b> Sensor/actuator cable, unshielded</li> <li>• <b>Application:</b> Zones with oils and lubricants, Drag chain operation, Robot</li> </ul>	YF2A14-050UB3XLEAX	2095608
	<ul style="list-style-type: none"> <li>• <b>Connection type head A:</b> Female connector, M12, 4-pin, angled, A-coded</li> <li>• <b>Connection type head B:</b> Flying leads</li> <li>• <b>Signal type:</b> Sensor/actuator cable</li> <li>• <b>Cable:</b> 2 m, 4-wire, PUR, halogen-free</li> <li>• <b>Description:</b> Sensor/actuator cable, unshielded</li> <li>• <b>Application:</b> Zones with oils and lubricants, Drag chain operation, Robot</li> </ul>	YG2A14-020UB3XLEAX	2095766
	<ul style="list-style-type: none"> <li>• <b>Connection type head A:</b> Female connector, M12, 4-pin, angled, A-coded</li> <li>• <b>Connection type head B:</b> Flying leads</li> <li>• <b>Signal type:</b> Sensor/actuator cable</li> <li>• <b>Cable:</b> 5 m, 4-wire, PUR, halogen-free</li> <li>• <b>Description:</b> Sensor/actuator cable, unshielded</li> <li>• <b>Application:</b> Zones with oils and lubricants, Drag chain operation, Robot</li> </ul>	YG2A14-050UB3XLEAX	2095767



## SICK AT A GLANCE

SICK is one of the leading manufacturers of intelligent sensors and sensor solutions for industrial applications. A unique range of products and services creates the perfect basis for controlling processes securely and efficiently, protecting individuals from accidents and preventing damage to the environment.

We have extensive experience in a wide range of industries and understand their processes and requirements. With intelligent sensors, we can deliver exactly what our customers need. In application centers in Europe, Asia and North America, system solutions are tested and optimized in accordance with customer specifications. All this makes us a reliable supplier and development partner.

Comprehensive services complete our offering: SICK LifeTime Services provide support throughout the machine life cycle and ensure safety and productivity.

For us, that is “Sensor Intelligence.”

## WORLDWIDE PRESENCE:

Contacts and other locations –[www.sick.com](http://www.sick.com)