

IMB30-20NNSVU2S

IMB

INDUCTIVE PROXIMITY SENSORS

SICK
Sensor Intelligence.

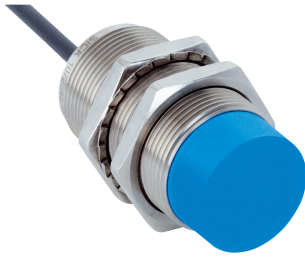
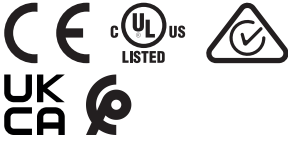

Illustration may differ



Ordering information

| Type | Part no. |
|-----------------|----------|
| IMB30-20NNSVU2S | 1072847 |

Included in delivery: BEF-MU-M30N (1)

Other models and accessories → www.sick.com/IMB

Detailed technical data

Features

| | |
|--|---|
| Housing | Metric |
| Housing | Standard design |
| Thread size | M30 x 1.5 |
| Diameter | Ø 30 mm |
| Sensing range S_n | 20 mm |
| Safe sensing range S_a | 16.2 mm |
| Installation type | Non-flush |
| Switching frequency | 500 Hz |
| Connection type | Cable, 3-wire, 2 m |
| Switching output | NPN |
| Output function | NO |
| Electrical wiring | DC 3-wire |
| Enclosure rating | IP68 ¹⁾ IP69K ²⁾ |
| Special features | Resistant against coolant lubricants, Visual adjustment indicator, Temperature resistance |
| Special applications | Zones with coolants and lubricants, Mobile machines, Difficult application conditions |
| Items supplied | Mounting nut, V2A stainless steel, with locking teeth (2x) |

¹⁾ According to EN 60529.

²⁾ According to ISO 20653:2013-03.

Mechanics/electronics

| | |
|-----------------------|---------------------|
| Supply voltage | 10 V DC ... 30 V DC |
| Ripple | ≤ 10 % |

¹⁾ At I_a max.

²⁾ Supply voltage U_B and constant ambient temperature T_a .

³⁾ Of S_r .

⁴⁾ When using the non-toothed side of the nut.

⁵⁾ Valid if toothed side of nut is used.

| | |
|---|--|
| Voltage drop | ≤ 2 V ¹⁾ |
| Hysteresis | 3 % ... 20 % |
| Reproducibility | ≤ 2 % ^{2) 3)} |
| Temperature drift (of S_r) | ± 10 % |
| EMC | According to EN 60947-5-2 |
| Continuous current I_a | ≤ 200 mA |
| No load current | ≤ 10 mA |
| Cable material | PUR |
| Conductor size | 0.34 mm ² |
| Cable diameter | Ø 4.5 mm |
| Short-circuit protection | ✓ |
| Power-up pulse protection | ✓ |
| Shock and vibration resistance | 100 g / 2 ms / 500 cycles; 150 g / 1 Mio cycles; 10 Hz ... 55 Hz / 1 mm; 55 Hz ... 500 Hz / 60 g |
| Ambient operating temperature | -40 °C ... +100 °C |
| Housing material | Stainless steel V2A, DIN 1.4305 / AISI 303 |
| Sensing face material | Plastic, LCP |
| Housing length | 60 mm |
| Thread length | 44 mm |
| Tightening torque, max. | Typ. 100 Nm ⁴⁾ Typ. 100 Nm ⁵⁾ |
| Protection class | III |
| UL File No. | E181493 |

1) At I_a max.

2) Supply voltage U_B and constant ambient temperature T_a.

3) Of S_r.

4) When using the non-toothed side of the nut.

5) Valid if toothed side of nut is used.

Safety-related parameters

| | |
|-------------------------|-------------|
| MTTF_D | 1,971 years |
| DC_{avg} | 0 % |

Reduction factors

| | |
|-----------------------------------|--|
| Note | The values are reference values which may vary |
| St37 steel (Fe) | 1 |
| Stainless steel (V2A, 304) | Approx. 0.78 |
| Aluminum (Al) | Approx. 0.44 |
| Copper (Cu) | Approx. 0.36 |
| Brass (Br) | Approx. 0.46 |

Installation note

| | |
|---------------|---------------------------------------|
| Remark | Associated graphic see "Installation" |
| A | 20 mm |
| B | 62 mm |

| | |
|----------|--------|
| C | 30 mm |
| D | 60 mm |
| E | 20 mm |
| F | 160 mm |

Classifications

| | |
|-----------------------|----------|
| ECLASS 5.0 | 27270101 |
| ECLASS 5.1.4 | 27270101 |
| ECLASS 6.0 | 27270101 |
| ECLASS 6.2 | 27270101 |
| ECLASS 7.0 | 27270101 |
| ECLASS 8.0 | 27270101 |
| ECLASS 8.1 | 27270101 |
| ECLASS 9.0 | 27270101 |
| ECLASS 10.0 | 27270101 |
| ECLASS 11.0 | 27270101 |
| ECLASS 12.0 | 27274001 |
| ETIM 5.0 | EC002714 |
| ETIM 6.0 | EC002714 |
| ETIM 7.0 | EC002714 |
| ETIM 8.0 | EC002714 |
| UNSPSC 16.0901 | 39122230 |

Installation note

Non-flush installation

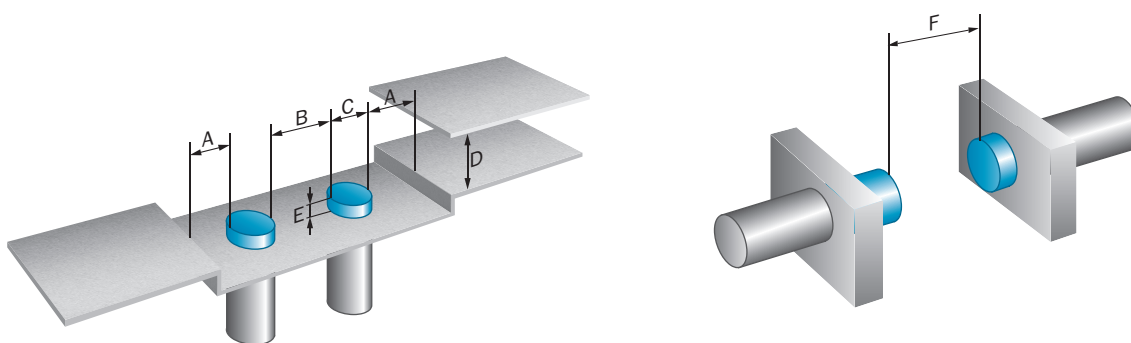

Connection diagram

Cd-001

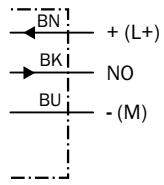

Response diagram

Response diagram

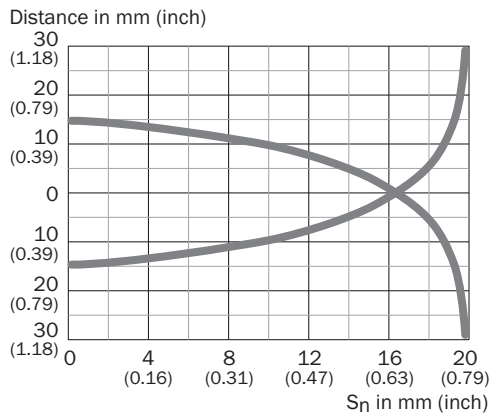

Functional principle

Installation aid

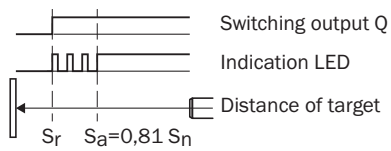

Dimensional drawing (Dimensions in mm (inch))



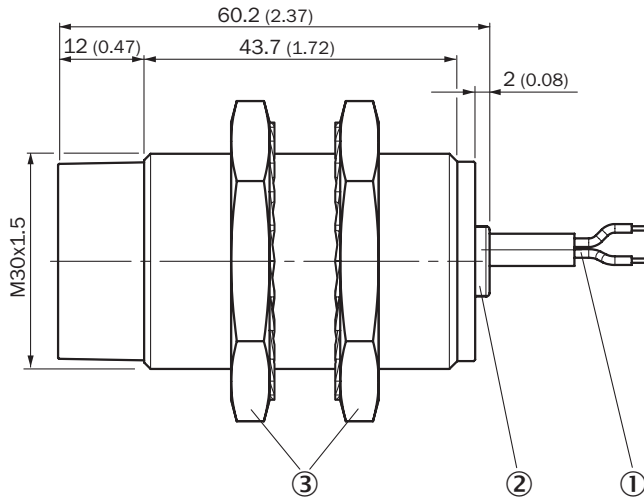

IMB30 Standard, cable, non-flush



- ① Connection
- ② Display LED
- ③ Fastening nuts (2 x); width across 36, stainless steel V2A

Recommended accessories

Other models and accessories → www.sick.com/IMB

| | Brief description | Type | Part no. |
|---|---|-------------|----------|
| Mounting brackets and plates | | | |
|  | Mounting plate for M30 sensors, steel, zinc coated, without mounting hardware | BEF-WG-M30 | 5321871 |
|  | Mounting bracket for M30 sensors, steel, zinc coated, without mounting hardware | BEF-WN-M30 | 5308445 |
| Others | | | |
|  | <ul style="list-style-type: none"> • Connection type head A: Female connector, M12, 4-pin, straight, A-coded • Description: Unshielded • Connection systems: Screw-type terminals • Permitted cross-section: ≤ 0.75 mm² • Application: Hygienic and washdown zones | DOS-1204-GN | 6028357 |
|  | <ul style="list-style-type: none"> • Connection type head A: Female connector, M12, 4-pin, angled, A-coded • Description: Unshielded • Connection systems: Screw-type terminals • Permitted cross-section: ≤ 0.75 mm² • Application: Hygienic and washdown zones | DOS-1204-WN | 6028358 |
|  | <ul style="list-style-type: none"> • Connection type head A: Male connector, M12, 4-pin, straight, A-coded • Description: Unshielded • Connection systems: Screw-type terminals • Permitted cross-section: ≤ 0.75 mm² • Application: Hygienic and washdown zones | STE-1204-GN | 6028359 |

| | Brief description | Type | Part no. |
|---|--|-------------|----------|
|  | <ul style="list-style-type: none">• Connection type head A: Male connector, M12, 4-pin, straight, A-coded• Description: Unshielded• Connection systems: Screw-type terminals• Permitted cross-section: ≤ 0.75 mm²• Note: For 2 cable connections• Application: Hygienic and washdown zones | STE-1204-TN | 6028360 |

SICK AT A GLANCE

SICK is one of the leading manufacturers of intelligent sensors and sensor solutions for industrial applications. A unique range of products and services creates the perfect basis for controlling processes securely and efficiently, protecting individuals from accidents and preventing damage to the environment.

We have extensive experience in a wide range of industries and understand their processes and requirements. With intelligent sensors, we can deliver exactly what our customers need. In application centers in Europe, Asia and North America, system solutions are tested and optimized in accordance with customer specifications. All this makes us a reliable supplier and development partner.

Comprehensive services complete our offering: SICK LifeTime Services provide support throughout the machine life cycle and ensure safety and productivity.

For us, that is “Sensor Intelligence.”

WORLDWIDE PRESENCE:

Contacts and other locations –www.sick.com