



IME08-02BPSZR2S

IME

INDUCTIVE PROXIMITY SENSORS

SICK
Sensor Intelligence.



Ordering information

| Type | Part no. |
|-----------------|----------|
| IME08-02BPSZR2S | 1102562 |

Included in delivery: BEF-MU-M08 (1)

Other models and accessories → www.sick.com/IME

Illustration may differ



Detailed technical data

Features

| | |
|--|--|
| Housing | Metric |
| Housing | Standard design |
| Thread size | M8 x 1 |
| Diameter | Ø 8 mm |
| Sensing range S_n | 2 mm |
| Safe sensing range S_a | 1.62 mm |
| Installation type | Flush |
| Switching frequency | 4,000 Hz |
| Connection type | Cable with connector M8, 4-pin, with knurled nuts, 2 m |
| Switching output | PNP |
| Output function | NO |
| Electrical wiring | DC 3-wire |
| Enclosure rating | IP67 ¹⁾ |
| Items supplied | Mounting nut, brass, nickel-plated (2x) |

¹⁾ According to EN 60529.

Mechanics/electronics

| | |
|---------------------------------------|---------------------|
| Supply voltage | 10 V DC ... 30 V DC |
| Ripple | ≤ 10 % |
| Voltage drop | ≤ 2 V ¹⁾ |
| Time delay before availability | ≤ 100 ms |

¹⁾ At I_a max.

²⁾ Supply voltage U_B and constant ambient temperature T_a .

³⁾ Of S_r .

| | |
|---|-----------------------------------|
| Hysteresis | 5 % ... 15 % |
| Reproducibility | ≤ 2 % ^{2) 3)} |
| Temperature drift (of S_r) | ± 10 % |
| EMC | According to EN 60947-5-2 |
| Continuous current I_a | ≤ 200 mA |
| No load current | ≤ 10 mA |
| Cable material | PVC |
| Conductor size | 0.25 mm ² |
| Cable diameter | Ø 0.39 mm |
| Short-circuit protection | ✓ |
| Power-up pulse protection | ✓ |
| Shock and vibration resistance | 30 g, 11 ms/10 Hz ... 55 Hz, 1 mm |
| Ambient operating temperature | -25 °C ... +75 °C |
| Housing material | Brass, nickel-plated |
| Sensing face material | Plastic, PA 66 |
| Housing length | 52 mm |
| Thread length | 34 mm |
| Tightening torque, max. | ≤ 5 Nm |
| UL File No. | NRKH.E181493 |

¹⁾ At I_a max.

²⁾ Supply voltage U_B and constant ambient temperature T_a.

³⁾ Of S_r.

Safety-related parameters

| | |
|-------------------------|-------------|
| MTTF_D | 1,735 years |
| DC_{avg} | 0 % |

Reduction factors

| | |
|-----------------------------------|--|
| Note | The values are reference values which may vary |
| St37 steel (Fe) | 1 |
| Stainless steel (V2A, 304) | Approx. 0.8 |
| Aluminum (Al) | Approx. 0.45 |
| Copper (Cu) | Approx. 0.4 |
| Brass (Br) | Approx. 0.4 |

Installation note

| | |
|---------------|---------------------------------------|
| Remark | Associated graphic see "Installation" |
| B | 16 mm |
| C | 8 mm |
| D | 6 mm |
| F | 16 mm |

Classifications

| | |
|-------------------|----------|
| ECLASS 5.0 | 27270101 |
|-------------------|----------|

| | |
|-----------------------|----------|
| ECLASS 5.1.4 | 27270101 |
| ECLASS 6.0 | 27270101 |
| ECLASS 6.2 | 27270101 |
| ECLASS 7.0 | 27270101 |
| ECLASS 8.0 | 27270101 |
| ECLASS 8.1 | 27270101 |
| ECLASS 9.0 | 27270101 |
| ECLASS 10.0 | 27270101 |
| ECLASS 11.0 | 27270101 |
| ECLASS 12.0 | 27274001 |
| ETIM 5.0 | EC002714 |
| ETIM 6.0 | EC002714 |
| ETIM 7.0 | EC002714 |
| ETIM 8.0 | EC002714 |
| UNSPSC 16.0901 | 39122230 |

Installation note

Flush installation

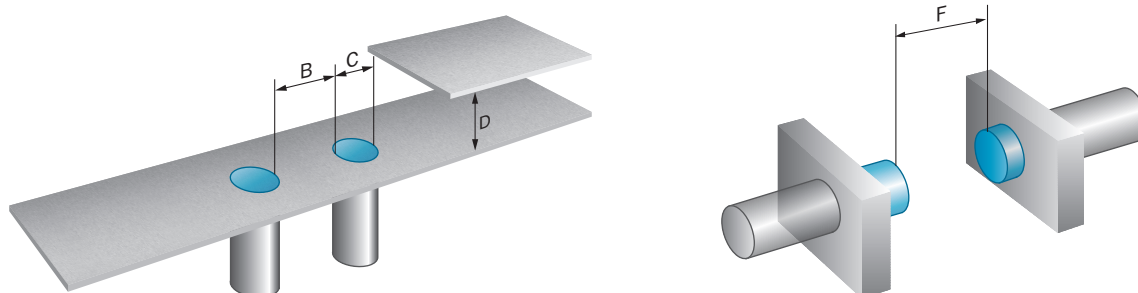

Connection diagram

Cd-007

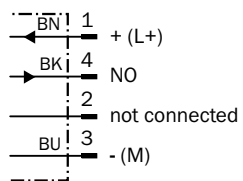

Dimensional drawing (Dimensions in mm (inch))



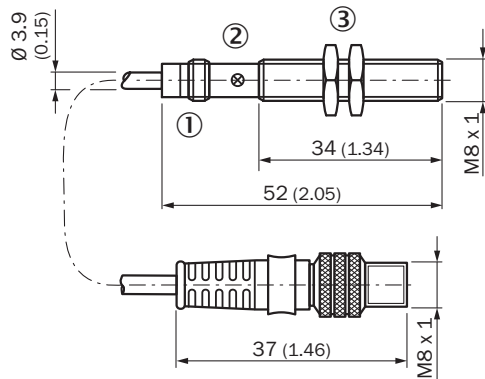



IM08, standard-body, flush, cable with connector with knurled nuts







- ① Connection
- ② Display LED
- ③ Fastening nuts (2x); width across 13, metal

Recommended accessories

Other models and accessories → www.sick.com/IME

| | Brief description | Type | Part no. |
|---|--|--------------------|----------|
| Mounting brackets and plates | | | |
|  | Mounting plate for M8 sensors, steel, zinc coated, without mounting hardware | BEF-WG-M08 | 5321722 |
|  | Mounting bracket for M8 sensors, steel, zinc coated, without mounting hardware | BEF-WN-M08 | 5321721 |
| Terminal and alignment brackets | | | |
|  | Clamping block for round sensors M8, without fixed stop, plastic (PA12), glass-fiber reinforced, mounting hardware included | BEF-KH-M08 | 2051477 |
| | Clamping block for round sensors M8, with fixed stop, plastic (PA12), glass-fiber reinforced, mounting hardware included | BEF-KHF-M08 | 2051478 |
| Others | | | |
|  | <ul style="list-style-type: none"> • Connection type head A: Female connector, M8, 3-pin, straight, A-coded • Description: Unshielded • Connection systems: Screw-type terminals • Permitted cross-section: 0.14 mm² ... 0.5 mm² | DOS-0803-G | 7902077 |
|  | <ul style="list-style-type: none"> • Connection type head A: Female connector, M8, 3-pin, angled, A-coded • Description: Unshielded • Connection systems: Solder connection • Permitted cross-section: ≤ 0.25 mm² | DOS-0803-W | 7902078 |
|  | <ul style="list-style-type: none"> • Connection type head A: Female connector, M8, 3-pin, straight, A-coded • Connection type head B: Flying leads • Signal type: Sensor/actuator cable • Cable: 2 m, 3-wire, PVC • Description: Sensor/actuator cable, unshielded • Application: Zones with chemicals, Uncontaminated zones | YF8U13-020VA1XLEAX | 2095860 |

| | Brief description | Type | Part no. |
|---|---|--------------------|----------|
|  | <ul style="list-style-type: none"> • Connection type head A: Female connector, M8, 3-pin, straight, A-coded • Connection type head B: Flying leads • Signal type: Sensor/actuator cable • Cable: 5 m, 3-wire, PVC • Description: Sensor/actuator cable, unshielded • Application: Zones with chemicals, Uncontaminated zones | YF8U13-050VA1XLEAX | 2095884 |
|  | <ul style="list-style-type: none"> • Connection type head A: Female connector, M8, 3-pin, straight, A-coded • Connection type head B: Flying leads • Signal type: Sensor/actuator cable • Cable: 10 m, 3-wire, PVC • Description: Sensor/actuator cable, unshielded • Application: Zones with chemicals, Uncontaminated zones | YF8U13-100VA1XLEAX | 2095885 |
|  | <ul style="list-style-type: none"> • Connection type head A: Female connector, M8, 3-pin, angled, A-coded • Connection type head B: Flying leads • Signal type: Sensor/actuator cable • Cable: 2 m, 3-wire, PVC • Description: Sensor/actuator cable, unshielded • Application: Zones with chemicals, Uncontaminated zones | YG8U13-020VA1XLEAX | 2096165 |
|  | <ul style="list-style-type: none"> • Connection type head A: Female connector, M8, 3-pin, angled, A-coded • Connection type head B: Flying leads • Signal type: Sensor/actuator cable • Cable: 5 m, 3-wire, PVC • Description: Sensor/actuator cable, unshielded • Application: Zones with chemicals, Uncontaminated zones | YG8U13-050VA1XLEAX | 2096166 |
|  | <ul style="list-style-type: none"> • Connection type head A: Female connector, M8, 3-pin, angled, A-coded • Connection type head B: Flying leads • Signal type: Sensor/actuator cable • Cable: 10 m, 3-wire, PVC • Description: Sensor/actuator cable, unshielded • Application: Zones with chemicals, Uncontaminated zones | YG8U13-100VA1XLEAX | 2096209 |

SICK AT A GLANCE

SICK is one of the leading manufacturers of intelligent sensors and sensor solutions for industrial applications. A unique range of products and services creates the perfect basis for controlling processes securely and efficiently, protecting individuals from accidents and preventing damage to the environment.

We have extensive experience in a wide range of industries and understand their processes and requirements. With intelligent sensors, we can deliver exactly what our customers need. In application centers in Europe, Asia and North America, system solutions are tested and optimized in accordance with customer specifications. All this makes us a reliable supplier and development partner.

Comprehensive services complete our offering: SICK LifeTime Services provide support throughout the machine life cycle and ensure safety and productivity.

For us, that is “Sensor Intelligence.”

WORLDWIDE PRESENCE:

Contacts and other locations –www.sick.com