



# IMM05-0B8PSVT0S

IMM

INDUCTIVE PROXIMITY SENSORS

**SICK**  
Sensor Intelligence.



### Ordering information

Type	Part no.
IMM05-0B8PSVT0S	1103984

Other models and accessories → [www.sick.com/IMM](http://www.sick.com/IMM)

Illustration may differ



### Detailed technical data

#### Features

<b>Housing</b>	Metric
<b>Housing</b>	Standard design
<b>Thread size</b>	M5 x 0.5
<b>Diameter</b>	Ø 5 mm
<b>Sensing range <math>S_n</math></b>	0.8 mm
<b>Safe sensing range <math>S_a</math></b>	0.648 mm
<b>Installation type</b>	Flush
<b>Switching frequency</b>	5,000 Hz
<b>Connection type</b>	Connector M8, 3-pin
<b>Switching output</b>	PNP
<b>Output function</b>	NO
<b>Electrical wiring</b>	DC 3-wire
<b>Enclosure rating</b>	IP67 <sup>1)</sup>
<b>Special features</b>	Visual adjustment indicator, IO-Link
<b>Items supplied</b>	Mounting nut, V2A stainless steel (2x) Washer, V2A stainless steel, with locking teeth (2x)

<sup>1)</sup> According to EN 60529.

#### Mechanics/electronics

<b>Supply voltage</b>	10 V DC ... 30 V DC
-----------------------	---------------------

<sup>1)</sup> Of  $V_S$ .

<sup>2)</sup> With  $I_a = 200$  mA.

<sup>3)</sup> Supply voltage  $U_B$  and constant ambient temperature  $T_a$ .

<b>Ripple</b>	$\leq 20\% \text{ } ^1$
<b>Voltage drop</b>	$\leq 2\text{ V} \text{ } ^2$
<b>Time delay before availability</b>	$\leq 10\text{ ms}$
<b>Hysteresis</b>	1 % ... 15 %
<b>Reproducibility</b>	$\leq 2.5\% \text{ } ^3$
<b>Temperature drift (of S<sub>r</sub>)</b>	$\leq 10\%$
<b>EMC</b>	EN 60947-5-2
<b>Continuous current I<sub>a</sub></b>	$\leq 200\text{ mA}$
<b>Short-circuit protection</b>	✓
<b>Power-up pulse protection</b>	✓
<b>Shock and vibration resistance</b>	30 g, 11 ms / 10 ... 55 Hz, 1 mm
<b>Ambient operating temperature</b>	-25 °C ... +70 °C
<b>Housing material</b>	Stainless steel V2A, DIN 1.4305 / AISI 303
<b>Sensing face material</b>	Plastic, LCP
<b>Housing length</b>	38 mm
<b>Thread length</b>	20 mm
<b>Tightening torque, max.</b>	$\leq 1.5\text{ Nm}$
<b>UL File No.</b>	NRKH.E348498

<sup>1)</sup> Of V<sub>S</sub>.

<sup>2)</sup> With I<sub>a</sub> = 200 mA.

<sup>3)</sup> Supply voltage U<sub>B</sub> and constant ambient temperature T<sub>a</sub>.

### Safety-related parameters

<b>MTF<sub>D</sub></b>	1,350 years
<b>DC<sub>avg</sub></b>	0 %
<b>T<sub>M</sub> (mission time)</b>	20 years

### Communication interface

<b>Communication interface</b>	IO-Link V1.1
<b>Communication Interface detail</b>	COM2 (38,4 kBaud)
<b>Cycle time</b>	10.4 ms
<b>Process data length</b>	1 Byte
<b>Process data structure</b>	Bit 0 = Sr reached Bit 1 = Sa reached

### Reduction factors

<b>Note</b>	The values are reference values which may vary
<b>St37 steel (Fe)</b>	1
<b>Stainless steel (V2A, 304)</b>	Approx. 0.72
<b>Aluminum (Al)</b>	Approx. 0.49
<b>Copper (Cu)</b>	Approx. 0.42
<b>Brass (Br)</b>	Approx. 0.56

Installation note

<b>Remark</b>	Associated graphic see "Installation"
<b>B</b>	0 mm
<b>C</b>	5 mm
<b>D</b>	2.4 mm
<b>F</b>	5 mm

Classifications

<b>ECLASS 5.0</b>	27270101
<b>ECLASS 5.1.4</b>	27270101
<b>ECLASS 6.0</b>	27270101
<b>ECLASS 6.2</b>	27270101
<b>ECLASS 7.0</b>	27270101
<b>ECLASS 8.0</b>	27270101
<b>ECLASS 8.1</b>	27270101
<b>ECLASS 9.0</b>	27270101
<b>ECLASS 10.0</b>	27270101
<b>ECLASS 11.0</b>	27270101
<b>ECLASS 12.0</b>	27274001
<b>ETIM 5.0</b>	EC002714
<b>ETIM 6.0</b>	EC002714
<b>ETIM 7.0</b>	EC002714
<b>ETIM 8.0</b>	EC002714
<b>UNSPSC 16.0901</b>	39122230

Installation note

Fixing with setscrew

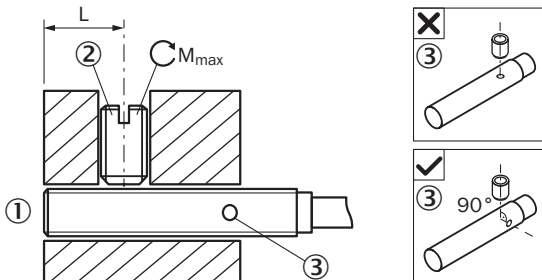

- ① Sensing face
- ② Recommended setscrew: M3, flat point
- ③ Display LED

Sensor type	Mounting area (L)	Max. tightening torque ( $M_{max}$ )
IMM05-1B5****K	5.5 mm ... 9 mm	≤ 0.2 Nm
IMM05-0B8****S IMM05-1B5****S	5.5 mm ... 19 mm	≤ 0.2 Nm
IMM05-0B8***T0S IMM05-1B5***T0S	5.5 mm ... 18 mm	≤ 0.2 Nm

Mounting using BEF-KH-M05 bracket



Sensor type	Mounting adapter	Overrun (P)	Max. tightening torque (M <sub>max</sub> )
IMM05-0B8***** IMM05-1B5*****	BEF-KH-M05, part no. 2101066	≥ 0 mm	≤ 0.6 Nm

Flush installation

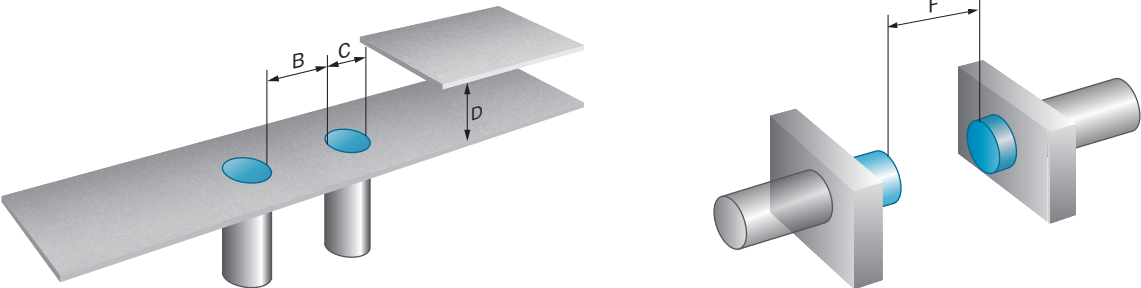

Connection diagram

Cd-002

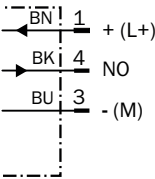

**Response diagram**

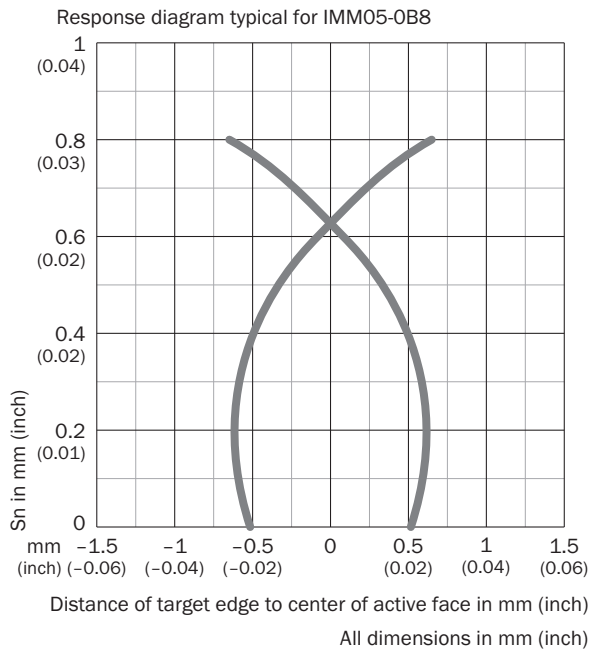

**Functional principle**

Installation aid

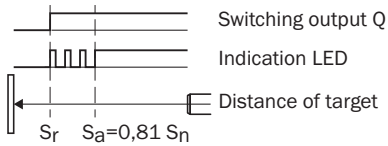

**Dimensional drawing** (Dimensions in mm (inch))



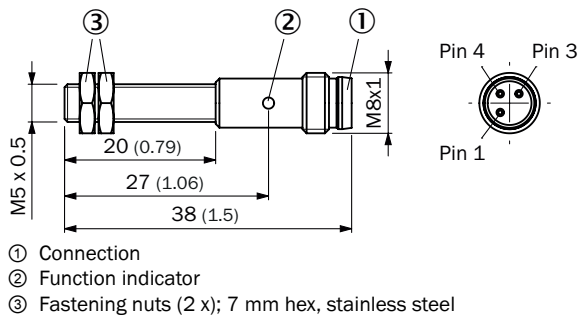





IMM05, standard variant, flush, male connector



## Recommended accessories

Other models and accessories → [www.sick.com/IMM](http://www.sick.com/IMM)

	Brief description	Type	Part no.
Terminal and alignment brackets			
	Plastic (PA6), without mounting hardware	BEF-KH-M05	2101066
Others			
	<ul style="list-style-type: none"> <li>• <b>Connection type head A:</b> 3-pin</li> <li>• <b>Number of slots:</b> 4</li> <li>• <b>Slot connection type:</b> M8, 3-pin, A-coded, female connector</li> <li>• <b>Description:</b> Unshielded</li> </ul>	Y8A34A2-C2A8000XXX	2115733
	<ul style="list-style-type: none"> <li>• <b>Connection type head A:</b> 3-pin</li> <li>• <b>Number of slots:</b> 4</li> <li>• <b>Slot connection type:</b> M8, 3-pin, A-coded, female connector</li> <li>• <b>Cable:</b> 5 m, 6-wire, PUR, halogen-free</li> <li>• <b>Description:</b> Unshielded</li> <li>• <b>Application:</b> Drag chain operation</li> </ul>	Y8A34A2-LXXXUAA050	2115727
	<ul style="list-style-type: none"> <li>• <b>Connection type head A:</b> 3-pin</li> <li>• <b>Number of slots:</b> 6</li> <li>• <b>Slot connection type:</b> M8, 3-pin, A-coded, female connector</li> <li>• <b>Description:</b> Unshielded</li> </ul>	Y8A36A2-C2A8000XXX	2115734
	<ul style="list-style-type: none"> <li>• <b>Connection type head A:</b> 3-pin</li> <li>• <b>Number of slots:</b> 6</li> <li>• <b>Slot connection type:</b> M8, 3-pin, A-coded, female connector</li> <li>• <b>Cable:</b> 5 m, 8-wire, PUR, halogen-free</li> <li>• <b>Description:</b> Unshielded</li> <li>• <b>Application:</b> Drag chain operation</li> </ul>	Y8A36A2-LXXXUBA050	2115728
	<ul style="list-style-type: none"> <li>• <b>Connection type head A:</b> Male connector, M8, 3-pin, straight, A-coded</li> <li>• <b>Description:</b> Unshielded</li> <li>• <b>Connection systems:</b> Screw-type terminals</li> <li>• <b>Permitted cross-section:</b> 0.14 mm<sup>2</sup> ... 0.5 mm<sup>2</sup></li> </ul>	STE-0803-G	6037322
	<ul style="list-style-type: none"> <li>• <b>Connection type head A:</b> Male connector, M8, 3-pin, angled, A-coded</li> <li>• <b>Description:</b> Unshielded</li> <li>• <b>Connection systems:</b> Screw-type terminals</li> <li>• <b>Permitted cross-section:</b> 0.14 mm<sup>2</sup> ... 0.5 mm<sup>2</sup></li> </ul>	STE-0803-WSK	6053170
	<ul style="list-style-type: none"> <li>• <b>Connection type head A:</b> Female connector, M8, 3-pin, straight, A-coded</li> <li>• <b>Connection type head B:</b> Flying leads</li> <li>• <b>Signal type:</b> Sensor/actuator cable</li> <li>• <b>Cable:</b> 2 m, 3-wire, PUR, halogen-free</li> <li>• <b>Description:</b> Sensor/actuator cable, unshielded</li> <li>• <b>Application:</b> Zones with oils and lubricants, Drag chain operation, Robot</li> </ul>	YF8U13-020UA1XLEAX	2094782
	<ul style="list-style-type: none"> <li>• <b>Connection type head A:</b> Female connector, M8, 3-pin, straight, A-coded</li> <li>• <b>Connection type head B:</b> Flying leads</li> <li>• <b>Signal type:</b> Sensor/actuator cable</li> <li>• <b>Cable:</b> 5 m, 3-wire, PUR, halogen-free</li> <li>• <b>Description:</b> Sensor/actuator cable, unshielded</li> <li>• <b>Application:</b> Zones with oils and lubricants, Drag chain operation, Robot</li> </ul>	YF8U13-050UA1XLEAX	2094788
	<ul style="list-style-type: none"> <li>• <b>Connection type head A:</b> Female connector, M8, 3-pin, angled, A-coded</li> <li>• <b>Connection type head B:</b> Flying leads</li> <li>• <b>Signal type:</b> Sensor/actuator cable</li> <li>• <b>Cable:</b> 2 m, 3-wire, PUR, halogen-free</li> <li>• <b>Description:</b> Sensor/actuator cable, unshielded</li> <li>• <b>Application:</b> Zones with oils and lubricants, Drag chain operation, Robot</li> </ul>	YG8U13-020UA1XLEAX	2094794

	Brief description	Type	Part no.
	<ul style="list-style-type: none"> <li>• <b>Connection type head A:</b> Female connector, M8, 3-pin, angled, A-coded</li> <li>• <b>Connection type head B:</b> Flying leads</li> <li>• <b>Signal type:</b> Sensor/actuator cable</li> <li>• <b>Cable:</b> 5 m, 3-wire, PUR, halogen-free</li> <li>• <b>Description:</b> Sensor/actuator cable, unshielded</li> <li>• <b>Application:</b> Zones with oils and lubricants, Drag chain operation, Robot</li> </ul>	YG8U13-050UA1XLEAX	2095586
	<ul style="list-style-type: none"> <li>• <b>Connection type head A:</b> Female connector, M8, 3-pin, straight, A-coded</li> <li>• <b>Connection type head B:</b> Male connector, M12, 3-pin, straight, A-coded</li> <li>• <b>Signal type:</b> Sensor/actuator cable</li> <li>• <b>Cable:</b> 2 m, 3-wire, PUR, halogen-free</li> <li>• <b>Description:</b> Sensor/actuator cable, unshielded</li> <li>• <b>Application:</b> Zones with oils and lubricants, Drag chain operation, Robot</li> </ul>	YF8U13-020UA1M2A13	2096169
	<ul style="list-style-type: none"> <li>• <b>Connection type head A:</b> Female connector, M8, 3-pin, straight, A-coded</li> <li>• <b>Connection type head B:</b> Male connector, M12, 3-pin, straight, A-coded</li> <li>• <b>Signal type:</b> Sensor/actuator cable</li> <li>• <b>Cable:</b> 5 m, 3-wire, PUR, halogen-free</li> <li>• <b>Description:</b> Sensor/actuator cable, unshielded</li> <li>• <b>Application:</b> Zones with oils and lubricants, Drag chain operation, Robot</li> </ul>	YF8U13-050UA1M2A13	2096170
	<ul style="list-style-type: none"> <li>• <b>Connection type head A:</b> Female connector, M8, 3-pin, angled, A-coded</li> <li>• <b>Connection type head B:</b> Male connector, M12, 3-pin, straight, A-coded</li> <li>• <b>Signal type:</b> Sensor/actuator cable</li> <li>• <b>Cable:</b> 2 m, 3-wire, PUR, halogen-free</li> <li>• <b>Description:</b> Sensor/actuator cable, unshielded</li> <li>• <b>Application:</b> Zones with oils and lubricants, Drag chain operation, Robot</li> </ul>	YG8U13-020UA1M2A13	2095748
	<ul style="list-style-type: none"> <li>• <b>Connection type head A:</b> Female connector, M8, 3-pin, straight, A-coded</li> <li>• <b>Connection type head B:</b> Male connector, M8, 3-pin, straight, A-coded</li> <li>• <b>Signal type:</b> Sensor/actuator cable</li> <li>• <b>Cable:</b> 2 m, 3-wire, PUR, halogen-free</li> <li>• <b>Description:</b> Sensor/actuator cable, unshielded</li> <li>• <b>Application:</b> Zones with oils and lubricants, Drag chain operation, Robot</li> </ul>	YF8U13-020UA1M8U13	2096304
	<ul style="list-style-type: none"> <li>• <b>Connection type head A:</b> Female connector, M8, 3-pin, straight, A-coded</li> <li>• <b>Connection type head B:</b> Male connector, M8, 3-pin, straight, A-coded</li> <li>• <b>Signal type:</b> Sensor/actuator cable</li> <li>• <b>Cable:</b> 5 m, 3-wire, PUR, halogen-free</li> <li>• <b>Description:</b> Sensor/actuator cable, unshielded</li> <li>• <b>Application:</b> Zones with oils and lubricants, Drag chain operation, Robot</li> </ul>	YF8U13-050UA1M8U13	2096308
	<ul style="list-style-type: none"> <li>• <b>Connection type head A:</b> Female connector, M8, 3-pin, angled, A-coded</li> <li>• <b>Connection type head B:</b> Male connector, M8, 3-pin, straight, A-coded</li> <li>• <b>Signal type:</b> Sensor/actuator cable</li> <li>• <b>Cable:</b> 2 m, 3-wire, PUR, halogen-free</li> <li>• <b>Description:</b> Sensor/actuator cable, unshielded</li> <li>• <b>Application:</b> Zones with oils and lubricants, Drag chain operation, Robot</li> </ul>	YG8U13-020UA1M8U13	2107781
	<ul style="list-style-type: none"> <li>• <b>Connection type head A:</b> Female connector, M8, 3-pin, angled, A-coded</li> <li>• <b>Connection type head B:</b> Male connector, M12, 3-pin, straight, A-coded</li> <li>• <b>Signal type:</b> Sensor/actuator cable</li> <li>• <b>Cable:</b> 5 m, 3-wire, PUR, halogen-free</li> <li>• <b>Description:</b> Sensor/actuator cable, unshielded</li> <li>• <b>Application:</b> Zones with oils and lubricants, Drag chain operation, Robot</li> </ul>	YG8U13-050UA1M2A13	2122842
	<ul style="list-style-type: none"> <li>• <b>Connection type head A:</b> Female connector, M8, 3-pin, straight, A-coded</li> <li>• <b>Connection type head B:</b> Male connector, M12, 3-pin, straight, A-coded</li> <li>• <b>Signal type:</b> Sensor/actuator cable</li> <li>• <b>Cable:</b> 3 m, 3-wire, PUR, halogen-free</li> <li>• <b>Description:</b> Sensor/actuator cable, unshielded</li> <li>• <b>Application:</b> Zones with oils and lubricants, Drag chain operation, Robot</li> </ul>	YF8U13-030UA1M2A13	2144589



## SICK AT A GLANCE

SICK is one of the leading manufacturers of intelligent sensors and sensor solutions for industrial applications. A unique range of products and services creates the perfect basis for controlling processes securely and efficiently, protecting individuals from accidents and preventing damage to the environment.

We have extensive experience in a wide range of industries and understand their processes and requirements. With intelligent sensors, we can deliver exactly what our customers need. In application centers in Europe, Asia and North America, system solutions are tested and optimized in accordance with customer specifications. All this makes us a reliable supplier and development partner.

Comprehensive services complete our offering: SICK LifeTime Services provide support throughout the machine life cycle and ensure safety and productivity.

For us, that is “Sensor Intelligence.”

## WORLDWIDE PRESENCE:

Contacts and other locations –[www.sick.com](http://www.sick.com)