



# IRT-P211E31S02

ZoneControl

MULTITASK PHOTOELECTRIC SENSORS

**SICK**  
Sensor Intelligence.



Illustration may differ



## Ordering information

Type	Part no.
IRT-P211E31S02	1063111

Other models and accessories → [www.sick.com/ZoneControl](http://www.sick.com/ZoneControl)

## Detailed technical data

### Features

<b>Functional principle</b>	Photoelectric proximity sensor
<b>Functional principle detail</b>	Background suppression
<b>Actuator</b>	Pneumatic, valve on board
<b>Max. number of sensors</b>	Approx. 30 <sup>1)</sup> Approx. 50 <sup>2)</sup>
<b>Logical principle of operation</b>	Single accumulation
<b>Type of Release</b>	Single release, block (slug) release
<b>Dimensions (W x H x D)</b>	49.9 mm x 135.4 mm x 48.9 mm
<b>Sensing range max.</b>	60 mm ... 900 mm
<b>Sensing range</b>	60 mm ... 900 mm
<b>Focus</b>	7°
<b>Type of light</b>	Infrared light
<b>Light source</b>	LED <sup>3)</sup>
<b>Light spot size (distance)</b>	Ø 20 mm (500 mm)
<b>Angle of dispersion</b>	7°
<b>Adjustment</b>	Potentiometer, 9 turns
<b>Special applications</b>	ZoneControl
<b>Special features</b>	SOLENOID.VALVE D 0.9 8B0 DC 24 V NO (#6010999)

<sup>1)</sup> When powered from the end of the IR daisy chain.

<sup>2)</sup> When powered from center of the IR daisy chain.

<sup>3)</sup> Average service life: 100,000 h at T<sub>U</sub> = +25 °C.

## Mechanics/electronics

<b>Supply voltage <math>U_B</math></b>	19.2 V DC ... 27.6 V DC <sup>1)</sup>
<b>Ripple</b>	< 5 V <sub>pp</sub> <sup>2)</sup>
<b>Current consumption</b>	20 mA <sup>3)</sup>
<b>Switching output</b>	PNP
<b>Signal voltage PNP HIGH/LOW</b>	Approx. $V_S - 0.5$ V / 0 V
<b>Output current <math>I_{max}</math></b>	≤ 100 mA
<b>Response time</b>	2 ms
<b>Switching frequency</b>	250 Hz
<b>Connection type</b>	Male connector M12, 4-pin
<b>Connection type for daisy chain</b>	Cable with female connector, M12, 4-pin 1.2 m
<b>Circuit protection</b>	A <sup>4)</sup> C <sup>5)</sup> D <sup>6)</sup>
<b>Protection class</b>	III
<b>Weight</b>	175 g
<b>Special device</b>	✓
<b>Housing material</b>	Plastic, ABS
<b>Enclosure rating</b>	IP65
<b>Shock and vibration resistance</b>	According to IEC 68
<b>Ambient operating temperature</b>	-10 °C ... +55 °C
<b>Ambient temperature, storage</b>	-40 °C ... +75 °C
<b>UL File No.</b>	NRKH.E189383 & NRKH7.E189383
<b>Medium for valves</b>	Compressed air or neutral gases filtered, non-lubricated or lubricated
<b>Design solenoid valve</b>	3/2-way valve
<b>Mode of operation solenoid valve</b>	Air to Brake (NO)
<b>Connection type solenoid valve</b>	Compressed air 2 x 8 mm diameter, control line 8 mm diameter
<b>Coil ratings</b>	24 V DC 1 W
<b>Air flow rate</b>	Approx. 20 NI/min
<b>Ventilation capacity</b>	Approx. 130 NI/min
<b>Operating pressure range</b>	2 bar ... 8 bar

<sup>1)</sup> Limit values.

<sup>2)</sup> May not fall below or exceed  $U_y$  tolerances.

<sup>3)</sup> Without load and valve deenergized.

<sup>4)</sup> A =  $V_S$  connections reverse-polarity protected.

<sup>5)</sup> C = interference suppression.

<sup>6)</sup> D = outputs overcurrent and short-circuit protected.

## Safety-related parameters

<b>MTTF<sub>D</sub></b>	1,227 years
<b>DC<sub>avg</sub></b>	0 %

## Pneumatic

<b>Coil ratings</b>	24 V DC 1 W
---------------------	-------------

<b>Medium for valves</b>	Compressed air or neutral gases filtered, non-lubricated or lubricated
<b>Design solenoid valve</b>	3/2-way valve
<b>Connection type solenoid valve</b>	Compressed air 2 x 8 mm diameter, control line 8 mm diameter
<b>Air flow rate</b>	Approx. 20 NI/min
<b>Ventilation capacity</b>	Approx. 130 NI/min
<b>Operating pressure range</b>	2 bar ... 8 bar

### Classifications

<b>ECLASS 5.0</b>	27270904
<b>ECLASS 5.1.4</b>	27270904
<b>ECLASS 6.0</b>	27270904
<b>ECLASS 6.2</b>	27270904
<b>ECLASS 7.0</b>	27270904
<b>ECLASS 8.0</b>	27270904
<b>ECLASS 8.1</b>	27270904
<b>ECLASS 9.0</b>	27270904
<b>ECLASS 10.0</b>	27270904
<b>ECLASS 11.0</b>	27270904
<b>ECLASS 12.0</b>	27270903
<b>ETIM 5.0</b>	EC002719
<b>ETIM 6.0</b>	EC002719
<b>ETIM 7.0</b>	EC002719
<b>ETIM 8.0</b>	EC002719
<b>UNSPSC 16.0901</b>	39121528

### Connection diagram

Cd-264

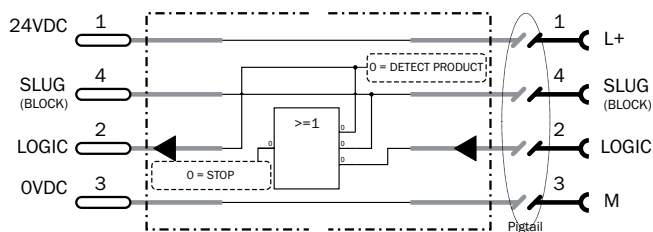

**Characteristic curve**

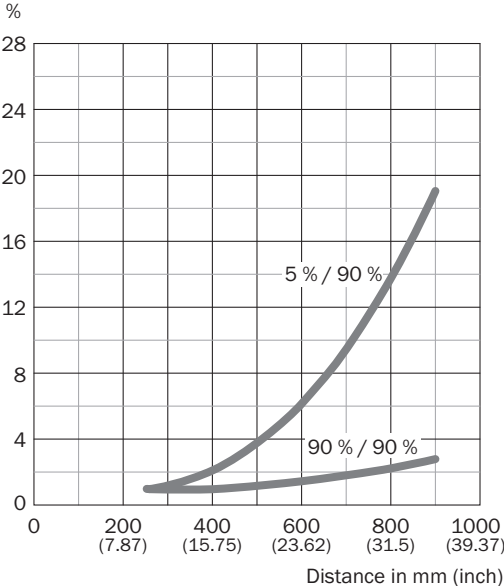

**Light spot size**

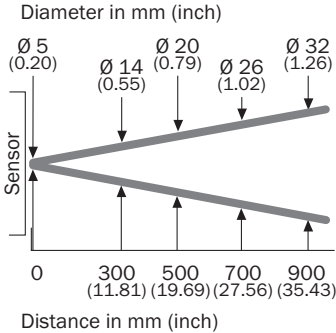

**Sensing range diagram**

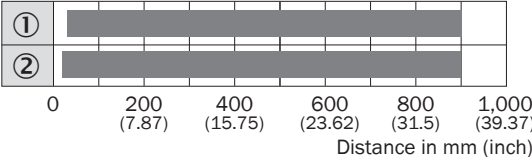

- Sensing range max.
- ① Sensing range to black, 5% remission factor
- ② Sensing range on white, 90% remission factor

Dimensional drawing (Dimensions in mm (inch))

IR, valve metric/imperial

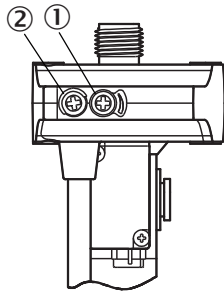

Valve	A	B	C	D	E	F
<b>A1x</b>	46.7 (1.84)	18 (0.71)	24.6 (0.97)	59.9 (2.36)	31.7 (1.25)	151.9 (5.98)
<b>E3x</b>	30.2 (1.19)	22 (0.87)	24.6 (0.97)	49.9 (1.96)	22.2 (0.87)	135.4 (5.33)
<b>E4x</b>	42.2 (1.66)	18 (0.71)	24.7 (0.97)	50 (1.97)	34.2 (1.35)	147.4 (5.80)
<b>E5x</b>	21.5 (0.85)	22 (0.87)	28.7 (1.13)	50 (1.97)	15.1 (0.59)	125.3 (4.93)



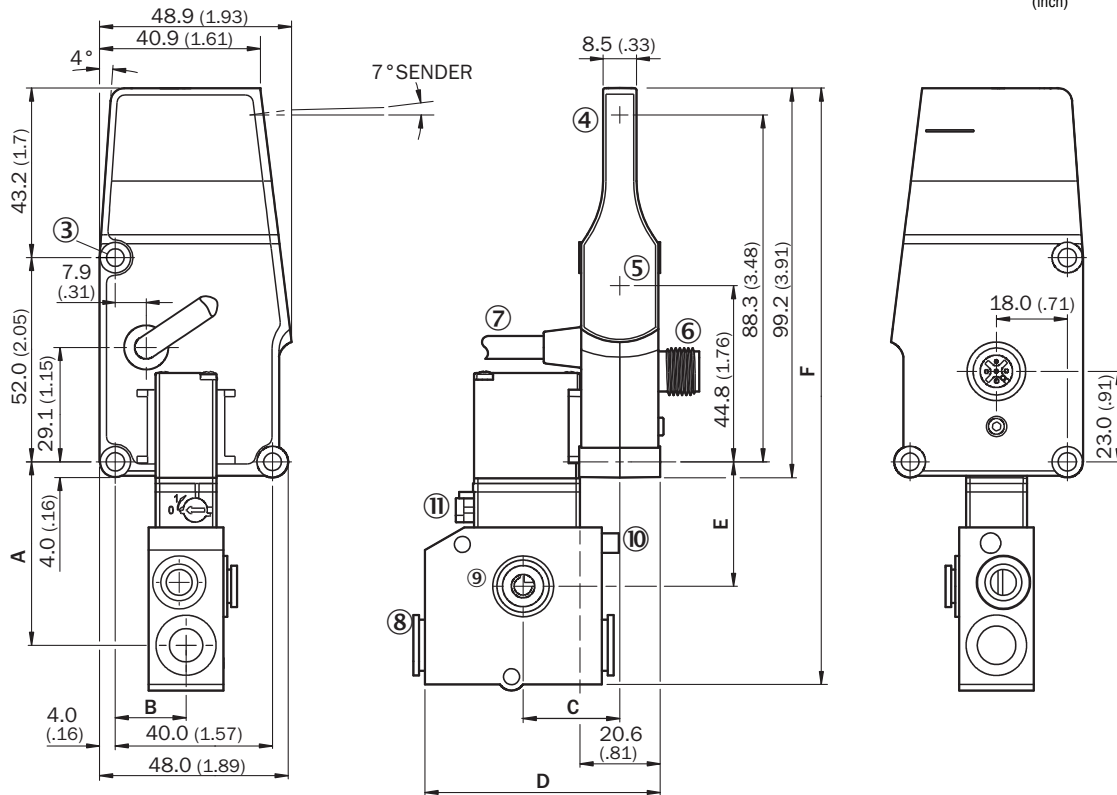

mm  
(inch)



- ① Potentiometer
- ② LED
- ③ Fixing hole
- ④ Center of optical axis, sender
- ⑤ Center of optical axis, receiver
- ⑥ Male connector M12, 4-pin
- ⑦ Series connection, cable with female connector

## Recommended accessories

Other models and accessories → [www.sick.com/ZoneControl](http://www.sick.com/ZoneControl)

	Brief description	Type	Part no.
<b>Mounting brackets and plates</b>			
	Mounting bracket, steel, zinc coated, mounting hardware included	BEF-WK-WTR	2051786
		BEF-WN-RT/IRT	2074621
<b>Others</b>			
	<ul style="list-style-type: none"> <li>• <b>Connection type head A:</b> Female connector, M12, 4-pin, straight, A-coded</li> <li>• <b>Connection type head B:</b> Flying leads</li> <li>• <b>Signal type:</b> Sensor/actuator cable</li> <li>• <b>Cable:</b> 5 m, 4-wire, PVC</li> <li>• <b>Description:</b> Sensor/actuator cable, unshielded</li> <li>• <b>Application:</b> Zones with chemicals, Uncontaminated zones</li> </ul>	YF2A14-050VB3XLEAX	2096235
		<ul style="list-style-type: none"> <li>• <b>Connection type head A:</b> Male connector, M12, 4-pin, straight, A-coded</li> <li>• <b>Description:</b> Unshielded</li> <li>• <b>Connection systems:</b> Screw-type terminals</li> <li>• <b>Permitted cross-section:</b> ≤ 0.75 mm<sup>2</sup></li> </ul>	STE-1204-G

## SICK AT A GLANCE

SICK is one of the leading manufacturers of intelligent sensors and sensor solutions for industrial applications. A unique range of products and services creates the perfect basis for controlling processes securely and efficiently, protecting individuals from accidents and preventing damage to the environment.

We have extensive experience in a wide range of industries and understand their processes and requirements. With intelligent sensors, we can deliver exactly what our customers need. In application centers in Europe, Asia and North America, system solutions are tested and optimized in accordance with customer specifications. All this makes us a reliable supplier and development partner.

Comprehensive services complete our offering: SICK LifeTime Services provide support throughout the machine life cycle and ensure safety and productivity.

For us, that is “Sensor Intelligence.”

## WORLDWIDE PRESENCE:

Contacts and other locations –[www.sick.com](http://www.sick.com)