



KT8L-N3756

KT8

CONTRAST SENSORS

SICK
Sensor Intelligence.



Illustration may differ



Ordering information

Type	Part no.
KT8L-N3756	1041352

Other models and accessories → www.sick.com/KT8

Detailed technical data

Features

Dimensions (W x H x D)	30.4 mm x 53 mm x 80 mm
Sensing distance	≤ 150 mm ¹⁾
Sensing distance tolerance	- 120 mm / + 650 mm
Housing design	Large
Light source	Laser, red ²⁾
Laser class	II (EN 60825-1:2014), IEC 60825-1:2014
Wave length	655 nm
Light emission	Long side of housing
Light spot size	Ø 3 mm ³⁾
Light spot direction	Round
Operating distance	30 mm ... 600 mm ⁴⁾
Adjustment	Teach-in button
Teach-in mode	Static 2-point teach-in Dynamic teach-in (min/max)
Function	Automatic drift correction

¹⁾ From leading edge of lens.

²⁾ Average service life: 50,000 h at T_U = +25 °C.

³⁾ At focal point = sensing distance 150 mm.

⁴⁾ With respect to black-white contrast 6 % / 90 %.

Mechanics/electronics

Supply voltage	10 V DC ... 30 V DC ¹⁾
-----------------------	-----------------------------------

¹⁾ Limit values when operated in short-circuit protected network: max. 8 A.

²⁾ May not exceed or fall below U_V tolerances.

³⁾ Without load.

⁴⁾ With light/dark ratio 1:1.

⁵⁾ Signal transit time with resistive load.

⁶⁾ Reference voltage DC 50 V.

Ripple	$\leq 5 V_{pp}^{2)}$
Current consumption	$< 80 \text{ mA}^{3)}$
Switching frequency	17 kHz ⁴⁾
Response time	30 μs ⁵⁾
Jitter	$< 15 \mu\text{s}$
Switching output	NPN
Switching output (voltage)	NPN: HIGH = approx. U_V / LOW $\leq 2 \text{ V}$
Analog output	0.3 mA ... 20 mA
Output current $I_{max.}$	100 mA
Input, teach-in (ET)	NPN Teach: $U < 2 \text{ V}$ Run: $U = 10 \text{ V} \dots < U_V$
Retention time (ET)	25 ms, non-volatile memory
Time delay	20 ms, adjustable
Connection type	Male connector M12, 5-pin
Protection class	II ⁶⁾
Circuit protection	U_V connections, reverse polarity protected Output Q short-circuit protected Interference pulse suppression
Enclosure rating	IP67
Weight	400 g
Housing material	Zinc diecast

1) Limit values when operated in short-circuit protected network: max. 8 A.

2) May not exceed or fall below U_V tolerances.

3) Without load.

4) With light/dark ratio 1:1.

5) Signal transit time with resistive load.

6) Reference voltage DC 50 V.

Ambient data

Ambient operating temperature	-10 °C ... +45 °C
Ambient temperature, storage	-10 °C ... +75 °C
Shock load	According to IEC 60068
UL File No.	242368, CDRH-conform

Classifications

ECLASS 5.0	27270906
ECLASS 5.1.4	27270906
ECLASS 6.0	27270906
ECLASS 6.2	27270906
ECLASS 7.0	27270906
ECLASS 8.0	27270906
ECLASS 8.1	27270906
ECLASS 9.0	27270906
ECLASS 10.0	27270906

ECLASS 11.0	27270906
ECLASS 12.0	27270906
ETIM 5.0	EC001820
ETIM 6.0	EC001820
ETIM 7.0	EC001820
ETIM 8.0	EC001820
UNSPSC 16.0901	39121528

Dimensional drawing (Dimensions in mm (inch))

KT8L Laser

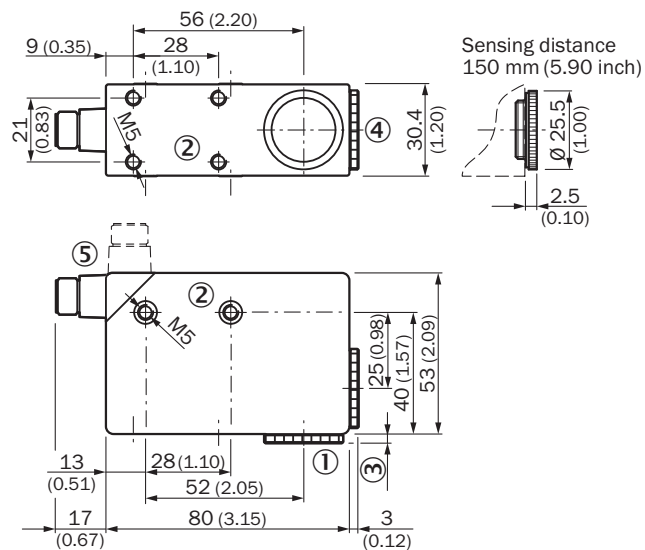

- ① Lens (light transmission), cannot be exchanged for pos. 4
- ② M5 threaded mounting hole, 5.5 mm deep
- ③ See dimensional drawing of lens
- ④ Blind screw cannot be replaced by pos. 1
- ⑤ Connector M12 (rotatable up to 90°)

Adjustments

KT8L Laser

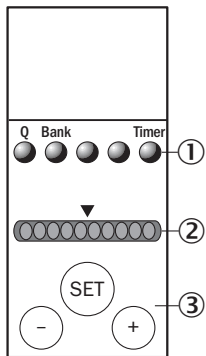

- ① Function signal indicators (yellow)
- ② Bar graph (green)
- ③ Teach-in pushbutton / +/- pushbutton

Connection diagram

Cd-329

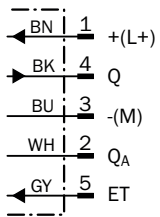

Concept of operation

Connection type and diagram

1. Position mark

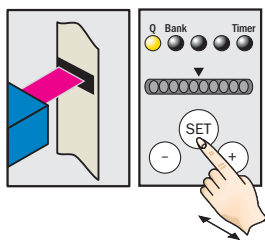

Press and hold SET button > 1 s.
Yellow LED flashes.

2. Position background

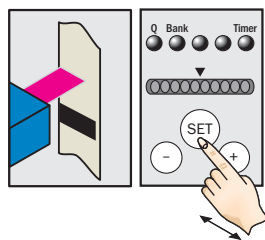

Press and hold SET button > 1 s.
Yellow LED goes out.

Connection type and diagram

1. Position background

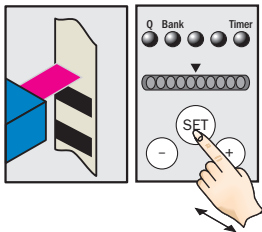

Press and hold SET button.
Emitted light turns white.

2. Move at least one repeat length using the light spot

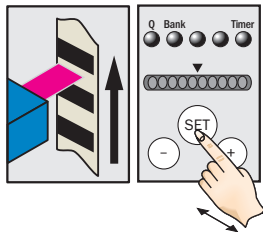

Hold down SET button.

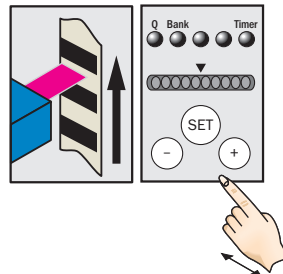

Release SET button.

Note

The bar display visualizes the detection reliability during teach-in. The more LEDs that illuminate, the better the teach-in:

1 LED illuminates = operation not reliable – contrast difference too low

≤ 4 LEDs illuminate = operation OK – sufficient contrast difference

> 4 LEDs illuminate = reliable operation – high contrast difference

Example

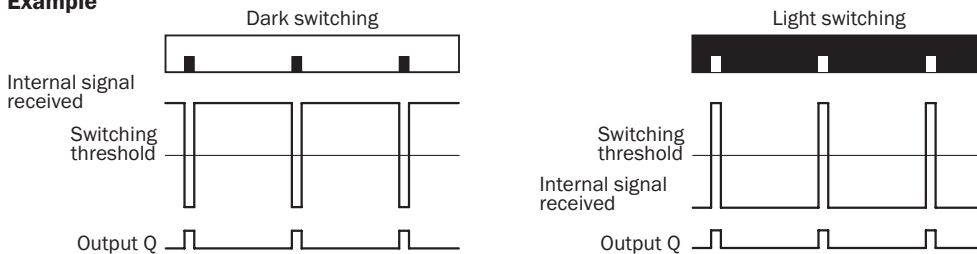

Switching characteristics

Light/dark setting is defined using teach-in sequence or menu, cf. operating instructions.

The switching threshold is set in the center between the background and the mark.

Teach-in and the light/dark setting can also be configured using an external control signal.

Configuration only possible via CAN (see operating instruction).





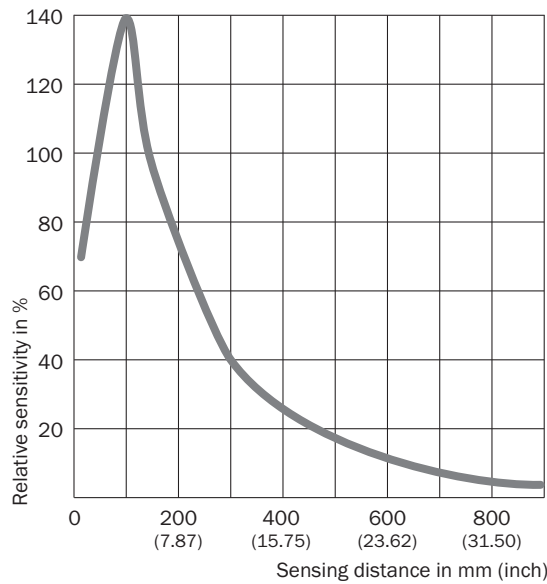

Sensing distance







Sensing distance



Recommended accessories

Other models and accessories → www.sick.com/KT8

	Brief description	Type	Part no.
Universal bar clamp systems			
	Plate G for universal clamp bracket, steel, zinc coated, Universal clamp (2022726), mounting hardware	BEF-KHS-G01	2022464
	Plate K for universal clamp bracket, steel, zinc coated, Universal clamp (2022726), mounting hardware	BEF-KHS-K01	2022718
	Universal bar clamp for mounting bars with 12-20 mm diameter, steel, zinc coated, without mounting hardware	BEF-KHS-KH1	2022726
	Mounting bar, straight, 200 mm, steel, steel, zinc coated, without mounting hardware	BEF-MS12G-A	4056054
	Mounting bar, straight, 300 mm, steel, steel, zinc coated, without mounting hardware	BEF-MS12G-B	4056055
	Mounting bar, L-shaped, 150 mm x 150 mm, steel, steel, zinc coated, without mounting hardware	BEF-MS12L-A	4056052
	Mounting bar, L-shaped, 250 x 250 mm, steel, steel, zinc coated, without mounting hardware	BEF-MS12L-B	4056053
Others			
	<ul style="list-style-type: none"> • Connection type head A: Female connector, M12, 5-pin, straight, A-coded • Description: Unshielded, Head A: female connector, M12, 5-pin, straight, unshielded, for cable diameter 4 mm ... 6 mm Head B: - • Connection systems: Screw-type terminals • Permitted cross-section: ≤ 0.75 mm² 	DOS-1205-G	6009719

	Brief description	Type	Part no.
	<ul style="list-style-type: none"> • Connection type head A: Female connector, M12, 5-pin, angled, A-coded • Description: Unshielded • Connection systems: Screw-type terminals • Permitted cross-section: ≤ 0.75 mm² 	DOS-1205-W	6009720
	<ul style="list-style-type: none"> • Connection type head A: Female connector, M12, 5-pin, angled, A-coded • Connection type head B: Flying leads • Signal type: Sensor/actuator cable • Cable: 2 m, 5-wire, PVC • Description: Sensor/actuator cable, unshielded • Application: Zones with chemicals 	YG2A15-020VB5XLEAX	2096215
	<ul style="list-style-type: none"> • Connection type head A: Female connector, M12, 5-pin, angled, A-coded • Connection type head B: Flying leads • Signal type: Sensor/actuator cable • Cable: 5 m, 5-wire, PVC • Description: Sensor/actuator cable, unshielded • Application: Zones with chemicals 	YG2A15-050VB5XLEAX	2096216
	<ul style="list-style-type: none"> • Connection type head A: Female connector, M12, 5-pin, angled, A-coded • Connection type head B: Flying leads • Signal type: Sensor/actuator cable • Cable: 10 m, 5-wire, PVC • Description: Sensor/actuator cable, unshielded • Application: Zones with chemicals 	YG2A15-100VB5XLEAX	2096217
	<ul style="list-style-type: none"> • Connection type head A: Female connector, M12, 5-pin, straight, A-coded • Connection type head B: Flying leads • Signal type: Sensor/actuator cable • Cable: 2 m, 5-wire, PVC • Description: Sensor/actuator cable, unshielded • Application: Zones with chemicals 	YF2A15-020VB5XLEAX	2096239
	<ul style="list-style-type: none"> • Connection type head A: Female connector, M12, 5-pin, straight, A-coded • Connection type head B: Flying leads • Signal type: Sensor/actuator cable • Cable: 5 m, 5-wire, PVC • Description: Sensor/actuator cable, unshielded • Application: Zones with chemicals 	YF2A15-050VB5XLEAX	2096240
	<ul style="list-style-type: none"> • Connection type head A: Female connector, M12, 5-pin, straight, A-coded • Connection type head B: Flying leads • Signal type: Sensor/actuator cable • Cable: 10 m, 5-wire, PVC • Description: Sensor/actuator cable, unshielded • Application: Zones with chemicals 	YF2A15-100VB5XLEAX	2096241

SICK AT A GLANCE

SICK is one of the leading manufacturers of intelligent sensors and sensor solutions for industrial applications. A unique range of products and services creates the perfect basis for controlling processes securely and efficiently, protecting individuals from accidents and preventing damage to the environment.

We have extensive experience in a wide range of industries and understand their processes and requirements. With intelligent sensors, we can deliver exactly what our customers need. In application centers in Europe, Asia and North America, system solutions are tested and optimized in accordance with customer specifications. All this makes us a reliable supplier and development partner.

Comprehensive services complete our offering: SICK LifeTime Services provide support throughout the machine life cycle and ensure safety and productivity.

For us, that is “Sensor Intelligence.”

WORLDWIDE PRESENCE:

Contacts and other locations –www.sick.com