



KTM-LN55182P

KTM

CONTRAST SENSORS

SICK
Sensor Intelligence.



Ordering information

Type	Part no.
KTM-LN55182P	1105838

Other models and accessories → www.sick.com/KTM

Illustration may differ



Detailed technical data

Features

Dimensions (W x H x D)	12 mm x 31.5 mm x 21 mm
Sensing distance	≤ 250 mm
Sensing distance tolerance	± 30 mm
Housing design	Small
Light source	Laser, red ¹⁾
Laser class	I
Wave length	680 nm
Light emission	Long side of housing
Light spot size	Ø 1.8 mm (250 mm)
Light spot direction	Round
Receiving filters	None
Max. web speed	10 m/s ²⁾
Adjustment	Teach-in button
Teach-in mode	2-point teach-in static/dynamic + proximity to mark ET: Teach-in dynamic

¹⁾ Average service life: 100,000 h at T_J = +25 °C.

²⁾ At mark size = 1.5 mm.

Mechanics/electronics

Supply voltage	10 V DC ... 30 V DC
-----------------------	---------------------

¹⁾ May not fall below or exceed U_V tolerances.

²⁾ Without load.

³⁾ With light/dark ratio 1:1.

⁴⁾ Signal transit time with resistive load.

⁵⁾ At supply voltage > 24 V, I_{max} = 50 mA. I_{max} is consumption count of all Q_n.

Ripple	$\leq 5 V_{pp}$ ¹⁾
Current consumption	$< 35 \text{ mA}$ ²⁾
Switching frequency	1.5 kHz ³⁾
Response time	$333 \mu\text{s}$ ⁴⁾
Jitter	$122 \mu\text{s}$
Accuracy	0.15 mm
Switching output	NPN
Switching output (voltage)	NPN: HIGH = approx. U_V / LOW $\leq 2 \text{ V}$
Switching mode	Light/dark switching
Output current I_{max}	100 mA ⁵⁾
Input, dynamic teach-in (ET)	NPN: Teach: $U < 2 \text{ V}$ NPN: Run: $U_V - 2 \text{ V}$ or open
Retention time (ET)	250 ms
Time delay	None
Connection type	Cable with M12 male connector, 4-pin, 0.3 m
Protection class	III
Circuit protection	U_V connections, reverse polarity protected Output Q short-circuit protected Interference pulse suppression
Enclosure rating	IP67
Weight	Approx. 24 g
Housing material	ABS
Optics material	PMMA
Indication	LED indicator green: power on LED indicator, yellow: Status switching output Q

¹⁾ May not fall below or exceed U_V tolerances.

²⁾ Without load.

³⁾ With light/dark ratio 1:1.

⁴⁾ Signal transit time with resistive load.

⁵⁾ At supply voltage $> 24 \text{ V}$, $I_{max} = 50 \text{ mA}$. I_{max} is consumption count of all Q_n .

Ambient data

Ambient operating temperature	$-20 \text{ }^\circ\text{C} \dots +50 \text{ }^\circ\text{C}$
Ambient temperature, storage	$-40 \text{ }^\circ\text{C} \dots +70 \text{ }^\circ\text{C}$
Shock load	According to IEC 60068
UL File No.	E181493

Connection type/pinouts

Connection type	Cable with M12 male connector, 4-pin, 0.3 m
Pinouts	
BN 1	+ (L+)
WH 2	ET
BU 3	- (M)
BK 4	Q

Classifications

ECLASS 5.0	27270906
ECLASS 5.1.4	27270906
ECLASS 6.0	27270906
ECLASS 6.2	27270906
ECLASS 7.0	27270906
ECLASS 8.0	27270906
ECLASS 8.1	27270906
ECLASS 9.0	27270906
ECLASS 10.0	27270906
ECLASS 11.0	27270906
ECLASS 12.0	27270906
ETIM 5.0	EC001820
ETIM 6.0	EC001820
ETIM 7.0	EC001820
ETIM 8.0	EC001820
UNSPSC 16.0901	39121528

Dimensional drawing (Dimensions in mm (inch))

KTM-Lxxxxx2P

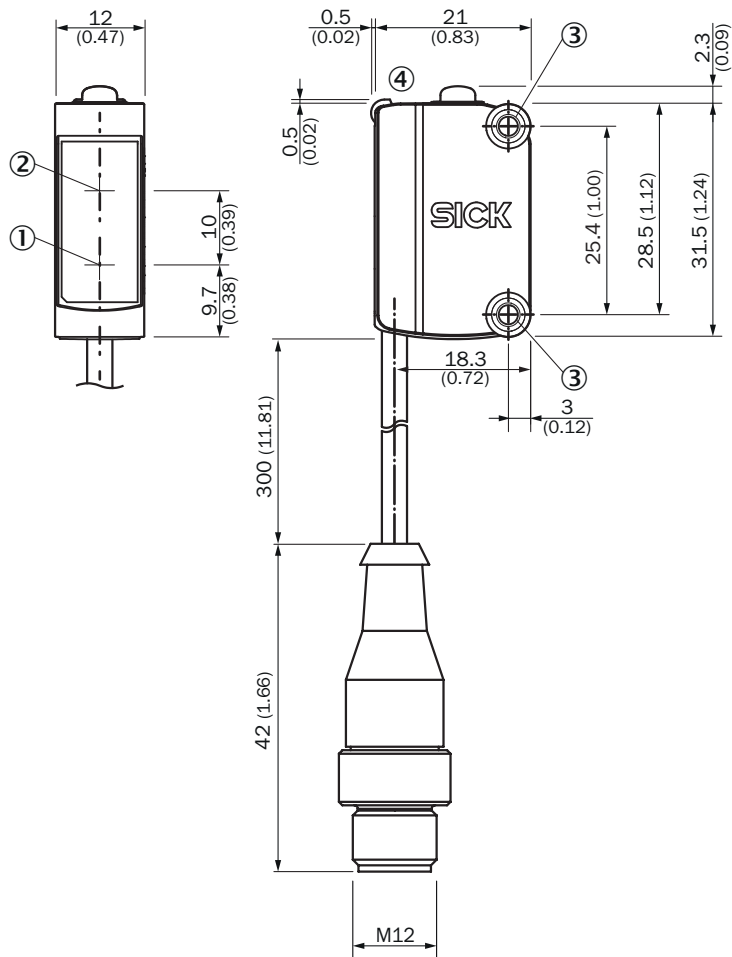

- ① Center of optical axis, sender
- ② Center of optical axis, receiver
- ③ Mounting holes M3
- ④ Display and adjustment elements

Pinouts

Pinouts, see table Technical data: **Connection type/pinouts**

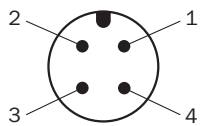

M12 male connector, 4-pin, A-coding

Adjustments

Display and adjustment elements

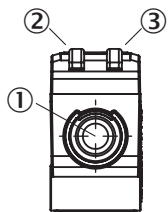

- ① Teach-in button
- ② LED yellow
- ③ LED green

Sensing distance

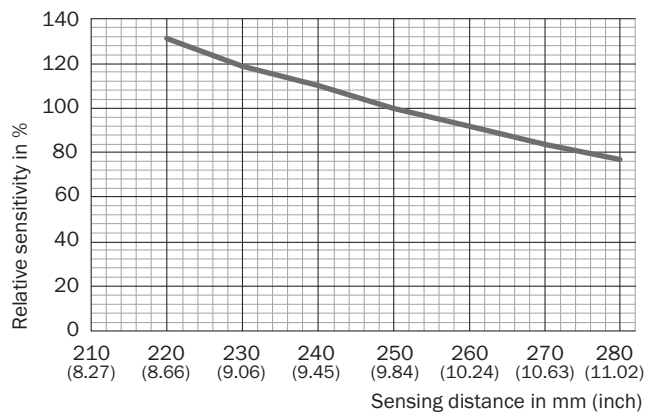

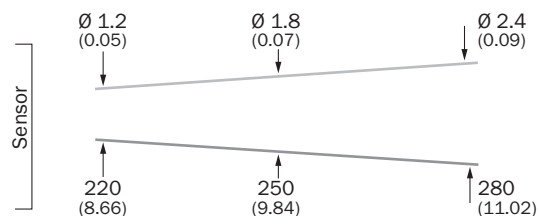

Light spot size

KTM-Lxx5xxx



Recommended accessories

Other models and accessories → www.sick.com/KTM

	Brief description	Type	Part no.
Others			
	<ul style="list-style-type: none"> • Connection type head A: Female connector, M12, 4-pin, straight, A-coded • Connection type head B: Male connector, M12, 4-pin, straight, A-coded • Signal type: Sensor/actuator cable • Cable: 5 m, 4-wire, PVC • Description: Sensor/actuator cable, unshielded • Application: Zones with chemicals 	YF2A14-050VB3M2A14	2096600
	<ul style="list-style-type: none"> • Connection type head A: Female connector, M12, 4-pin, straight, A-coded • Connection type head B: Flying leads • Signal type: Sensor/actuator cable • Cable: 5 m, 4-wire, PVC • Description: Sensor/actuator cable, unshielded • Application: Zones with chemicals 	YF2A14-050VB3XLEAX	2096235

SICK AT A GLANCE

SICK is one of the leading manufacturers of intelligent sensors and sensor solutions for industrial applications. A unique range of products and services creates the perfect basis for controlling processes securely and efficiently, protecting individuals from accidents and preventing damage to the environment.

We have extensive experience in a wide range of industries and understand their processes and requirements. With intelligent sensors, we can deliver exactly what our customers need. In application centers in Europe, Asia and North America, system solutions are tested and optimized in accordance with customer specifications. All this makes us a reliable supplier and development partner.

Comprehensive services complete our offering: SICK LifeTime Services provide support throughout the machine life cycle and ensure safety and productivity.

For us, that is “Sensor Intelligence.”

WORLDWIDE PRESENCE:

Contacts and other locations –www.sick.com