



# KTM-LN557A2P

KTM

CONTRAST SENSORS

**SICK**  
Sensor Intelligence.



Illustration may differ



### Ordering information

Type	Part no.
KTM-LN557A2P	1105834

Other models and accessories → [www.sick.com/KTM](http://www.sick.com/KTM)

### Detailed technical data

#### Features

<b>Dimensions (W x H x D)</b>	12 mm x 31.5 mm x 21 mm
<b>Sensing distance</b>	≤ 250 mm
<b>Sensing distance tolerance</b>	± 30 mm
<b>Housing design</b>	Small
<b>Light source</b>	Laser, red <sup>1)</sup>
<b>Laser class</b>	I
<b>Wave length</b>	680 nm
<b>Light emission</b>	Long side of housing
<b>Light spot size</b>	Ø 1.8 mm (250 mm)
<b>Light spot direction</b>	Round
<b>Receiving filters</b>	None
<b>Max. web speed</b>	10 m/s <sup>2)</sup>
<b>Adjustment</b>	Teach-in button, Teach-in button
<b>Teach-in mode</b>	2-point teach-in static/dynamic + proximity to mark

<sup>1)</sup> Average service life: 100,000 h at T<sub>J</sub> = +25 °C.

<sup>2)</sup> At mark size = 1.5 mm.

## Mechanics/electronics

<b>Supply voltage</b>	10 V DC ... 30 V DC
<b>Ripple</b>	$\leq 5 V_{pp}^{1)}$
<b>Current consumption</b>	$< 35 \text{ mA}^{2)}$
<b>Switching frequency</b>	1.5 kHz <sup>3)</sup>
<b>Response time</b>	333 $\mu\text{s}^{4)}$
<b>Jitter</b>	122 $\mu\text{s}$
<b>Accuracy</b>	0.15 mm
<b>Switching output</b>	NPN
<b>Switching output (voltage)</b>	NPN: HIGH = approx. $U_V$ / LOW $\leq 2 \text{ V}$
<b>Switching mode</b>	Light/dark switching
<b>Output current <math>I_{max}</math></b>	100 mA <sup>5)</sup>
<b>Retention time (ET)</b>	250 ms
<b>Time delay</b>	Switch-off delay, 520 ms (via IO-Link)
<b>Connection type</b>	Cable with M12 male connector, 4-pin, 0.3 m
<b>Protection class</b>	III
<b>Circuit protection</b>	$U_V$ connections, reverse polarity protected Output Q short-circuit protected Interference pulse suppression
<b>Enclosure rating</b>	IP67
<b>Weight</b>	Approx. 24 g
<b>Housing material</b>	ABS
<b>Optics material</b>	PMMA
<b>Indication</b>	LED indicator green: power on LED indicator, yellow: Status switching output Q

<sup>1)</sup> May not fall below or exceed  $U_V$  tolerances.

<sup>2)</sup> Without load.

<sup>3)</sup> With light/dark ratio 1:1.

<sup>4)</sup> Signal transit time with resistive load.

<sup>5)</sup> At supply voltage  $> 24 \text{ V}$ ,  $I_{max} = 50 \text{ mA}$ .  $I_{max}$  is consumption count of all  $Q_n$ .

## Communication interface

<b>IO-Link</b>	✓, V1.1
Data transmission rate	38,4 kbit/s (COM2)
Cycle time	2.3 ms
Process data length	16 Bit
<b>Process data structure A</b>	Bit 0 = switching signal $Q_{L1}$ Bit 1 = switching signal $Q_{L2}$ Bit 2 = switching signal $Q_{Int1}$ Bit 3 ... 5 = empty Bit 6 ... 15 = measuring value
<b>Process data structure B</b>	Bit 0 = switching signal $Q_{L1}$ Bit 1 = switching signal $Q_{L2}$ Bit 2 = switching signal $Q_{Int1}$ Bit 3 ... 15 = empty
<b>Digital output</b>	$Q_1, Q_2$

Number	2
--------	---

Ambient data

<b>Ambient operating temperature</b>	-20 °C ... +50 °C
<b>Ambient temperature, storage</b>	-40 °C ... +70 °C
<b>Shock load</b>	According to IEC 60068
<b>UL File No.</b>	E181493

Connection type/pinouts

<b>Connection type</b>	Cable with M12 male connector, 4-pin, 0.3 m
<b>Pinouts</b>	
BN 1	+ (L+)
WH 2	Q
BU 3	- (M)
BK 4	Q/C

Classifications

<b>ECLASS 5.0</b>	27270906
<b>ECLASS 5.1.4</b>	27270906
<b>ECLASS 6.0</b>	27270906
<b>ECLASS 6.2</b>	27270906
<b>ECLASS 7.0</b>	27270906
<b>ECLASS 8.0</b>	27270906
<b>ECLASS 8.1</b>	27270906
<b>ECLASS 9.0</b>	27270906
<b>ECLASS 10.0</b>	27270906
<b>ECLASS 11.0</b>	27270906
<b>ECLASS 12.0</b>	27270906
<b>ETIM 5.0</b>	EC001820
<b>ETIM 6.0</b>	EC001820
<b>ETIM 7.0</b>	EC001820
<b>ETIM 8.0</b>	EC001820
<b>UNSPSC 16.0901</b>	39121528

Dimensional drawing (Dimensions in mm (inch))

KTM-Lxxxxx2P

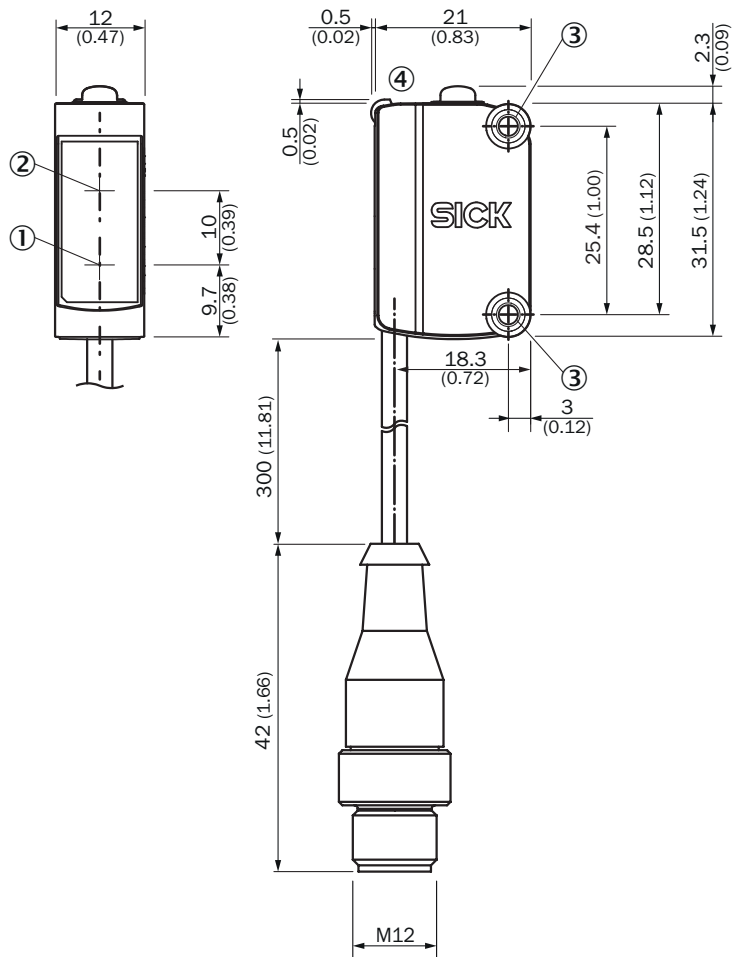

- ① Center of optical axis, sender
- ② Center of optical axis, receiver
- ③ Mounting holes M3
- ④ Display and adjustment elements

Pinouts

Pinouts, see table Technical data: **Connection type/pinouts**

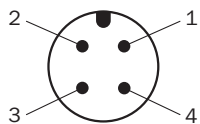

M12 male connector, 4-pin, A-coding

## Adjustments

Display and adjustment elements

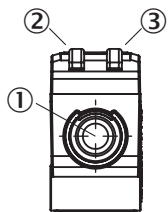

- ① Teach-in button
- ② LED yellow
- ③ LED green

## Sensing distance

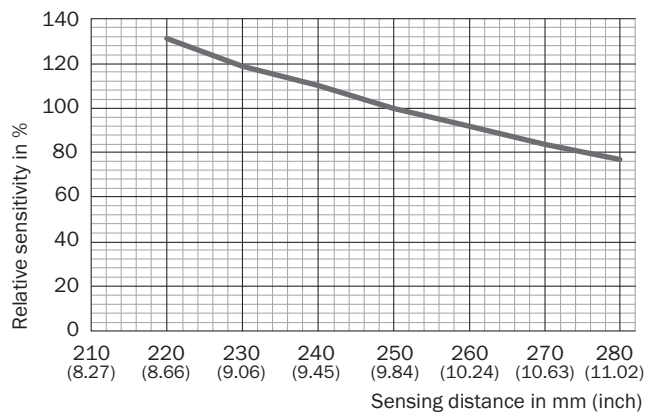

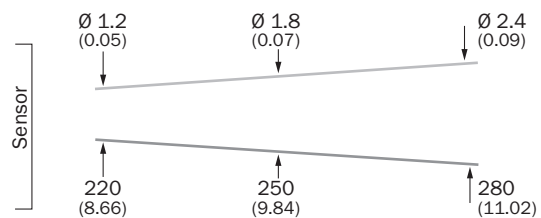

## Light spot size

KTM-Lxx5xxx



## Recommended accessories

Other models and accessories → [www.sick.com/KTM](http://www.sick.com/KTM)

	Brief description	Type	Part no.
Others			
	<ul style="list-style-type: none"> <li>• <b>Connection type head A:</b> Female connector, M12, 4-pin, straight, A-coded</li> <li>• <b>Connection type head B:</b> Male connector, M12, 4-pin, straight, A-coded</li> <li>• <b>Signal type:</b> Sensor/actuator cable</li> <li>• <b>Cable:</b> 5 m, 4-wire, PVC</li> <li>• <b>Description:</b> Sensor/actuator cable, unshielded</li> <li>• <b>Application:</b> Zones with chemicals</li> </ul>	YF2A14-050VB3M2A14	2096600
	<ul style="list-style-type: none"> <li>• <b>Connection type head A:</b> Female connector, M12, 4-pin, straight, A-coded</li> <li>• <b>Connection type head B:</b> Flying leads</li> <li>• <b>Signal type:</b> Sensor/actuator cable</li> <li>• <b>Cable:</b> 5 m, 4-wire, PVC</li> <li>• <b>Description:</b> Sensor/actuator cable, unshielded</li> <li>• <b>Application:</b> Zones with chemicals</li> </ul>	YF2A14-050VB3XLEAX	2096235

## SICK AT A GLANCE

SICK is one of the leading manufacturers of intelligent sensors and sensor solutions for industrial applications. A unique range of products and services creates the perfect basis for controlling processes securely and efficiently, protecting individuals from accidents and preventing damage to the environment.

We have extensive experience in a wide range of industries and understand their processes and requirements. With intelligent sensors, we can deliver exactly what our customers need. In application centers in Europe, Asia and North America, system solutions are tested and optimized in accordance with customer specifications. All this makes us a reliable supplier and development partner.

Comprehensive services complete our offering: SICK LifeTime Services provide support throughout the machine life cycle and ensure safety and productivity.

For us, that is “Sensor Intelligence.”

## WORLDWIDE PRESENCE:

Contacts and other locations –[www.sick.com](http://www.sick.com)