



# LBV310-XXAGDTVMX

LBV300

LEVEL SENSORS

**SICK**  
Sensor Intelligence.



Illustration may differ



### Ordering information

Type	Part no.
LBV310-XXAGDTVMX	6039278

Other models and accessories → [www.sick.com/LBV300](http://www.sick.com/LBV300)

### Detailed technical data

#### Features

<b>Medium</b>	Bulk solids
<b>Measurement</b>	Switch
<b>Probe length</b>	220 mm
<b>Process pressure</b>	-1 bar ... 25 bar
<b>Process temperature</b>	-50 °C ... +150 °C
<b>Fill material density</b>	≥ 0.008 g/cm <sup>3</sup>
<b>Particle size</b>	< 10 mm

#### Performance

<b>Accuracy of sensor element</b>	± 10 mm
<b>Reproducibility</b>	≤ 5 mm
<b>Response time</b>	500 ms when covered / 1,000 ms when uncovered
<b>MTBF</b>	4,61*10 <sup>6</sup> h

#### Electronics

<b>Residual ripple</b>	≤ 5 V <sub>pp</sub>
<b>Initialization time</b>	< 2 s
<b>VDE protection class 2</b>	✓
<b>Connection type</b>	M20 x 1.5
<b>Output signal</b>	1 x PNP/NPN
<b>Supply voltage</b>	Volt-free transistor output PNP/ NPN: 10 V DC ... 55 V DC
<b>Hysteresis</b>	10 mm
<b>Output current</b>	< 300 mA
<b>Inductive load</b>	≤ 1 H
<b>Capacitive load</b>	100 nF
<b>Enclosure rating</b>	IP66 / IP67

#### Mechanics

<b>Process connection</b>	G 1½ A PN 25
<b>Housing material</b>	Stainless steel (investment casting) 316L

<b>Sensor material</b>	Stainless steel 1.4404
------------------------	------------------------

## Ambient data

<b>Ambient operating temperature</b>	-40 °C ... +80 °C
<b>Ambient temperature, storage</b>	-40 °C ... +80 °C

## Classifications

<b>ECLASS 5.0</b>	27273202
<b>ECLASS 5.1.4</b>	27273202
<b>ECLASS 6.0</b>	27273202
<b>ECLASS 6.2</b>	27273202
<b>ECLASS 7.0</b>	27273202
<b>ECLASS 8.0</b>	27273202
<b>ECLASS 8.1</b>	27273202
<b>ECLASS 9.0</b>	27273202
<b>ECLASS 10.0</b>	27273202
<b>ECLASS 11.0</b>	27273202
<b>ECLASS 12.0</b>	27273106
<b>ETIM 5.0</b>	EC002654
<b>ETIM 6.0</b>	EC002654
<b>ETIM 7.0</b>	EC002654
<b>ETIM 8.0</b>	EC002654
<b>UNSPSC 16.0901</b>	41111938

## Type code

## LBV310 type code

**Certification**

XX	without
CX	ATEX II 1G, ½ G, 2G Ex ia IIC T6
CK	ATEX II 1G, ½ G, 2G Ex ia IIC T6+ATEX II 1/2 D IP6X T
LX	ATEX II 1G, ½ G, 2G Ex d IIC T6
LK	ATEX II ½ G, 2G Ex d IIC T6+ATEX II 1/2 D, 2D IP6X
GX	ATEX II ½ D IP6X T

**Execution / Process temperature**

A	Standard / -50 °C ... +150 °C
B	With spacer / -50 °C ... +250 °C
C	Detection of solids in water / -50 °C ... +150 °C

**Process connection / Material**

GD	Thread G 1 ½ A, PN 25 / 316L
ND	Thread 1 ½" NPT, PN 25 / 316L
EF	Flange DN 50, PN 40, form C, DIN 2501 / 316L
No	Flange DN 80, PN 40, form C, DIN 2501 / 316L
er-	
ror	
ZF	Flange DN 100, PN 6, form C, DIN 2501 / 316L
MF	Flange DN 100, PN 16, form C, DIN 2501 / 316L
OF	Flange DN 100, PN 40, form C, DIN 2501 / 316L
QF	Flange DN 150, PN 16, form C, DIN 2501 / 316L
2F	Flange DN 200, PN 10, form C, DIN 2501 / 316L
EB	Flange DN 50, PN 40, EN 1092-1 Form B1 / 316L
HA	Flange 2", 150 lb RF, ANSI B16.5 / 316L
HE	Flange 2", 150 lb FF, ANSI B16.5 / 316L
IA	Flange 2", 300 lb RF, ANSI B16.5 / 316L
OA	Flange 3", 150 lb RF, ANSI B16.5 / 316L

OE	Flange 3", 150 lb FF, ANSI B16.5 / 316L
PA	Flange 3", 300 lb RF, ANSI B16.5 / 316L
JA	Flange 3 ½", 150 lb RF, ANSI B16.5 / 316L
SA	Flange 4", 150 lb RF, ANSI B16.5 / 316L
UA	Flange 4", 300 lb RF, ANSI B16.5 / 316L
AU	Flange DN 50, 10K RF, JIS / 316L
BU	Flange DN 80, 10K RF, JIS / 316L
CU	Flange DN 100, 10K RF, JIS / 316L

<b>Electronics</b>	
C	Contact-free switch 20 ... 253 V AC (DC)
R	Relay (DPDT) 20 ... 72 V DC / 20 ... 253 V AC (3A)
T	Transistor (NPN/PNP) 10 ... 55V DC
N	NAMUR signal

<b>Housing / Enclosure rating</b>	
K	Plastic / IP 66, IP 67
A	Aluminum / IP 66, IP 67
V	Stainless steel (investment casting) 316L / IP 66, IP 67
8	Stainless steel (electropolished) 316L / IP 66, IP 67

<b>Cable entry / Male connector connection</b>	
M	M20 x 1.5 / Without
N	½" NPT / Without

  

LBV310 -										X
----------	--	--	--	--	--	--	--	--	--	---

Not all variants of the type code can be combined!

[Dimensional drawing](#) (Dimensions in mm (inch))

Temperature adapter

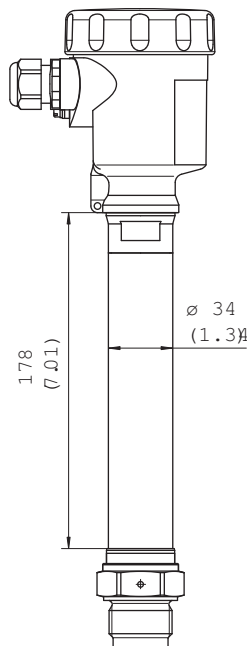

LBV310 threaded version G 1½ A (DIN ISO 228/1)



### Connection diagram

PNP action

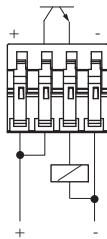

NPN action

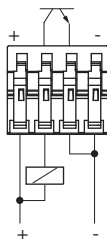

### Transistor connection diagram

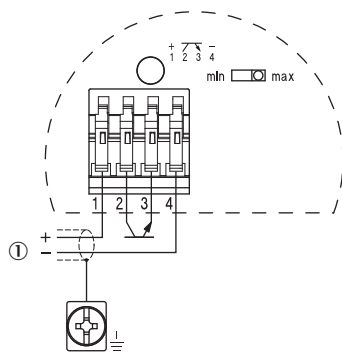

### Instruction for installation

#### Horizontal mounting

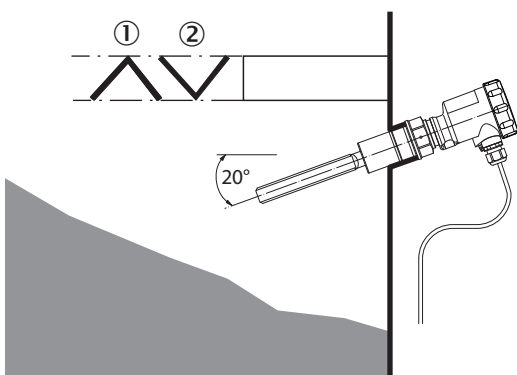

- ① Protective sheet
- ② Concave protective sheet for abrasive solids

#### Flow orientation of the tuning fork

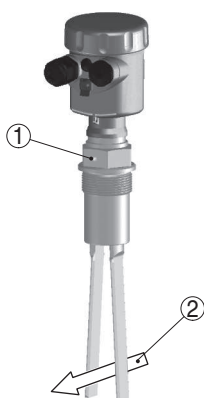

- ① Marking with screwed version
- ② Direction of flow

## Recommended accessories

Other models and accessories → [www.sick.com/LBV300](http://www.sick.com/LBV300)

	Brief description	Type	Part no.
Electronic modules			
	Transistor (PNP/NPN): 10 V DC ... 55 V DC	ECD-RE-LB-VPNP-0001	6038667
Mounting brackets and plates			
	BEF-MU-316G20-ALBV	BEF-MU-316G20-ALBV	5322462

## SICK AT A GLANCE

SICK is one of the leading manufacturers of intelligent sensors and sensor solutions for industrial applications. A unique range of products and services creates the perfect basis for controlling processes securely and efficiently, protecting individuals from accidents and preventing damage to the environment.

We have extensive experience in a wide range of industries and understand their processes and requirements. With intelligent sensors, we can deliver exactly what our customers need. In application centers in Europe, Asia and North America, system solutions are tested and optimized in accordance with customer specifications. All this makes us a reliable supplier and development partner.

Comprehensive services complete our offering: SICK LifeTime Services provide support throughout the machine life cycle and ensure safety and productivity.

For us, that is “Sensor Intelligence.”

## WORLDWIDE PRESENCE:

Contacts and other locations –[www.sick.com](http://www.sick.com)