



# LBV320-XXTNDRANX01100

LBV300

LEVEL SENSORS

**SICK**  
Sensor Intelligence.



Illustration may differ



### Ordering information

Type	Part no.
LBV320-XXTNDRANX01100	6038374

Other models and accessories → [www.sick.com/LBV300](http://www.sick.com/LBV300)

### Detailed technical data

#### Features

<b>Medium</b>	Bulk solids
<b>Measurement</b>	Switch
<b>Probe length</b>	1,100 mm
<b>Process pressure</b>	-1 bar ... 6 bar
<b>Process temperature</b>	-20 °C ... +80 °C
<b>Fill material density</b>	≥ 0.008 g/cm <sup>3</sup>
<b>Particle size</b>	< 10 mm
<b>Tensile strength</b>	≤ 3,000 N

#### Performance

<b>Accuracy of sensor element</b>	± 10 mm
<b>Reproducibility</b>	≤ 5 mm
<b>Response time</b>	500 ms when covered / 1,000 ms when uncovered
<b>MTBF</b>	4,61*10 <sup>6</sup> h

#### Electronics

<b>Power consumption</b>	5 mA ... 30 mA
<b>Initialization time</b>	< 2 s
<b>VDE protection class 1</b>	✓
<b>Connection type</b>	½" NPT
<b>Output signal</b>	Double relay (DPDT)
<b>Supply voltage</b>	Double relay (DPDT): 20 V DC ... 72 V DC / 20 V AC ... 253 V AC
<b>Hysteresis</b>	10 mm
<b>Output current</b>	> 10 µA; < 3A AC, 1A DC
<b>Inductive load</b>	750 VA 54 W
<b>Capacitive load</b>	750 VA 54 W
<b>Contact load</b>	Min. 50 mW / max. 750 VA, 54 W
<b>Enclosure rating</b>	IP66 / IP67

## Mechanics

<b>Process connection</b>	1 1/2" NPT PN 25 / stainless steel 316L
<b>Housing material</b>	Aluminum
<b>Sensor material</b>	Stainless steel 316L, 318LN, PUR

## Ambient data

<b>Ambient operating temperature</b>	-40 °C ... +80 °C
<b>Ambient temperature, storage</b>	-40 °C ... +80 °C

## Classifications

<b>ECLASS 5.0</b>	27273202
<b>ECLASS 5.1.4</b>	27273202
<b>ECLASS 6.0</b>	27273202
<b>ECLASS 6.2</b>	27273202
<b>ECLASS 7.0</b>	27273202
<b>ECLASS 8.0</b>	27273202
<b>ECLASS 8.1</b>	27273202
<b>ECLASS 9.0</b>	27273202
<b>ECLASS 10.0</b>	27273202
<b>ECLASS 11.0</b>	27273202
<b>ECLASS 12.0</b>	27273106
<b>ETIM 5.0</b>	EC002654
<b>ETIM 6.0</b>	EC002654
<b>ETIM 7.0</b>	EC002654
<b>ETIM 8.0</b>	EC002654
<b>UNSPSC 16.0901</b>	41111938

## Type code

## LBV320 type code

**Certification**

XX	without
CX	ATEX II 1G, ½ G, 2G Ex ia IIC T6
CK	ATEX II 1G, ½ G, 2G Ex ia IIC T6+ATEX II 1/2D IP6X T
GX	ATEX II ½ D IP6X T

**Execution / Process temperature**

C	Cable PUR, detection of solids in water / -20 °C ... +80 °C
H	Cable FEP / -40 °C ... +150 °C
T	Cable PUR / -20 °C ... +80 °C

**Process connection / Material**

XX	Without / 316L
GD	Thread G 1 ½ A, PN 16 / 316L
ND	Thread 1 ½" NPT, PN 16 / 316L
EF	Flange DN 50, PN 40, form C, DIN 2501 / 316L
No er- ror	Flange DN 80, PN 40, form C, DIN 2501 / 316L
ZF	Flange DN 100, PN 6, form C, DIN 2501 / 316L
MF	Flange DN 100, PN 16, form C, DIN 2501 / 316L
OF	Flange DN 100, PN 40, form C, DIN 2501 / 316L
QF	Flange DN150, PN 16, form C, DIN 2501 / 316L
2F	Flange DN 200, PN 10, form C, DIN 2501 / 316L



LBV320 with PUR suspension cable, threaded version G 1½ A (DIN ISO 228/1)



### Connection diagram

Double relay connection diagram

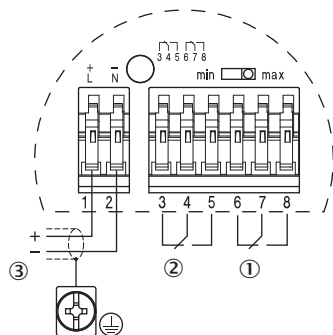

- ① Relay output
- ② Relay output
- ③ Power supply

### Instruction for installation

Horizontal mounting



- ① Protective sheet
- ② Concave protective sheet for abrasive solids

LBV320 Filling and emptying centered



Filling in the center, emptying laterally

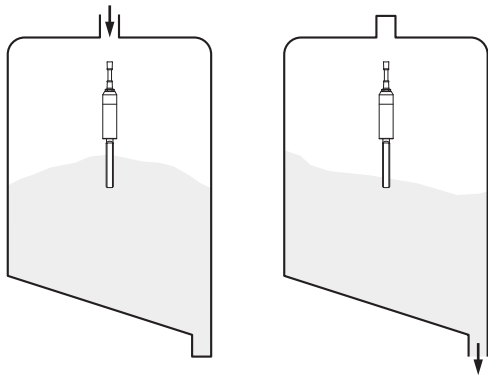

- ① LBV320
- ② Discharge opening
- ③ Filling opening

Flow orientation of the tuning fork



- ① Marking with screwed version
- ② Direction of flow

### Recommended accessories

Other models and accessories → [www.sick.com/LBV300](http://www.sick.com/LBV300)

	Brief description	Type	Part no.
Electronic modules			
	Double relay (DPDT): 20 V DC ... 72 V DC / 20 ... 250 V AC	ECD-RE-LB-VREL-0001	6038666

	Brief description	Type	Part no.
Mounting brackets and plates			
	BEF-MU-316G20-ALBV	BEF-MU-316G20-ALBV	5322462



## SICK AT A GLANCE

SICK is one of the leading manufacturers of intelligent sensors and sensor solutions for industrial applications. A unique range of products and services creates the perfect basis for controlling processes securely and efficiently, protecting individuals from accidents and preventing damage to the environment.

We have extensive experience in a wide range of industries and understand their processes and requirements. With intelligent sensors, we can deliver exactly what our customers need. In application centers in Europe, Asia and North America, system solutions are tested and optimized in accordance with customer specifications. All this makes us a reliable supplier and development partner.

Comprehensive services complete our offering: SICK LifeTime Services provide support throughout the machine life cycle and ensure safety and productivity.

For us, that is “Sensor Intelligence.”

## WORLDWIDE PRESENCE:

Contacts and other locations –[www.sick.com](http://www.sick.com)