



LBV330-XXAGDRAMX1100

LBV300

LEVEL SENSORS

SICK
Sensor Intelligence.



Illustration may differ



Ordering information

Type	Part no.
LBV330-XXAGDRAMX1100	6038205

Other models and accessories → www.sick.com/LBV300

Detailed technical data

Features

Medium	Bulk solids
Measurement	Switch
Probe length	1,100 mm
Process pressure	-1 bar ... 25 bar
Process temperature	-50 °C ... +150 °C
Fill material density	≥ 0.008 g/cm ³
Particle size	< 10 mm

Performance

Accuracy of sensor element	± 10 mm
Reproducibility	≤ 5 mm
Response time	500 ms when covered / 1,000 ms when uncovered
MTBF	4,61*10 ⁶ h

Electronics

Power consumption	5 mA ... 30 mA
Initialization time	< 2 s
VDE protection class 1	✓
Connection type	M20 x 1.5
Output signal	Double relay (DPDT)
Supply voltage	Double relay (DPDT): 20 V DC ... 72 V DC / 20 V AC ... 253 V AC
Hysteresis	10 mm
Output current	> 10 μA; < 3A AC, 1A DC
Inductive load	750 VA 54 W
Capacitive load	750 VA 54 W
Contact load	Min. 50 mW / max. 750 VA, 54 W
Enclosure rating	IP66 / IP67

Mechanics

Process connection	G 1½ A PN 25
---------------------------	--------------

Housing material	Aluminum
Sensor material	Stainless steel 1.4404

Ambient data

Ambient operating temperature	-40 °C ... +80 °C
Ambient temperature, storage	-40 °C ... +80 °C

Classifications

ECLASS 5.0	27273202
ECLASS 5.1.4	27273202
ECLASS 6.0	27273202
ECLASS 6.2	27273202
ECLASS 7.0	27273202
ECLASS 8.0	27273202
ECLASS 8.1	27273202
ECLASS 9.0	27273202
ECLASS 10.0	27273202
ECLASS 11.0	27273202
ECLASS 12.0	27273106
ETIM 5.0	EC002654
ETIM 6.0	EC002654
ETIM 7.0	EC002654
ETIM 8.0	EC002654
UNSPSC 16.0901	41111938

Type code

LBV330 type code

Certification

XX	without
CX	ATEX II 1G, ½ G, 2G Ex ia IIC T6
CK	ATEX II 1G, ½ G, 2G Ex ia IIC T6+ATEX II 1/2 D IP6X T
LX	ATEX II 1G, ½ G, 2G Ex d IIC T6
LK	ATEX II ½ G, 2G Ex d IIC T6+ATEX II 1/2 D, 2D IP6X
GX	ATEX II ½ D IP6X T

Execution / Process temperature

A	Standard / -50 °C ... +150 °C
B	With spacer / -50 °C ... +250 °C
C	Detection of solids in water / -50 °C ... +150 °C

Process connection / Material

GD	Thread G 1 ½ A, PN 25 / 316L
ND	Thread 1 ½" NPT, PN 25 / 316L
EF	Flange DN 50, PN 40, form C, DIN 2501 / 316L
No er- ror	Flange DN 80, PN 40, form C, DIN 2501 / 316L
ZF	Flange DN 100, PN 6, form C, DIN 2501 / 316L
MF	Flange DN 100 PN 16 form C, DIN2501 / 316L
OF	Flange DN 100, PN 40, form C, DIN 2501 / 316L
QF	Flange DN 150, PN 16, form C, DIN 2501 / 316L
2F	Flange DN 200, PN 10, form C, DIN 2501 / 316L
EB	Flange DN 50, PN 40, EN 1092-1, form B1 / 316L
HA	Flange 2", 150 lb RF, ANSI B16.5 / 316L
HE	Flange 2", 150 lb FF, ANSI B16.5 / 316L

LBV330 threaded version G 1½ A (DIN ISO 228/1)



Connection diagram

Double relay connection diagram

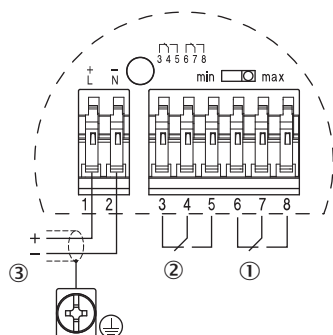

- ① Relay output
- ② Relay output
- ③ Power supply

Instruction for installation

Horizontal mounting

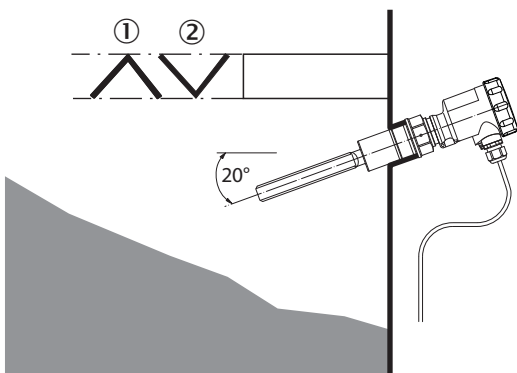

- ① Protective sheet
- ② Concave protective sheet for abrasive solids

Flow orientation of the tuning fork

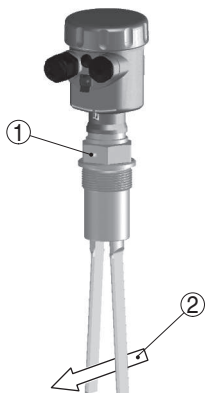

- ① Marking with screwed version
- ② Direction of flow

Recommended accessories

Other models and accessories → www.sick.com/LBV300

	Brief description	Type	Part no.
Electronic modules			
	Double relay (DPDT): 20 V DC ... 72 V DC / 20 ... 250 V AC	ECD-RE-LB-VREL-0001	6038666
Mounting brackets and plates			
	BEF-MU-316G20-ALBV	BEF-MU-316G20-ALBV	5322462

SICK AT A GLANCE

SICK is one of the leading manufacturers of intelligent sensors and sensor solutions for industrial applications. A unique range of products and services creates the perfect basis for controlling processes securely and efficiently, protecting individuals from accidents and preventing damage to the environment.

We have extensive experience in a wide range of industries and understand their processes and requirements. With intelligent sensors, we can deliver exactly what our customers need. In application centers in Europe, Asia and North America, system solutions are tested and optimized in accordance with customer specifications. All this makes us a reliable supplier and development partner.

Comprehensive services complete our offering: SICK LifeTime Services provide support throughout the machine life cycle and ensure safety and productivity.

For us, that is “Sensor Intelligence.”

WORLDWIDE PRESENCE:

Contacts and other locations –www.sick.com