



# LBV331-XXAGCTKMx0250

LBV301

LEVEL SENSORS

**SICK**  
Sensor Intelligence.



Illustration may differ



### Ordering information

Type	Part no.
LBV331-XXAGCTKMX0250	6047887

Other models and accessories → [www.sick.com/LBV301](http://www.sick.com/LBV301)

### Detailed technical data

#### Features

<b>Medium</b>	Bulk solids
<b>Measurement</b>	Switch
<b>Probe length</b>	250 mm
<b>Process pressure</b>	-1 bar ... 16 bar
<b>Process temperature</b>	-50 °C ... +150 °C
<b>Fill material density</b>	≥ 0.02 g/cm <sup>3</sup>

#### Performance

<b>Accuracy of sensor element</b>	± 10 mm
<b>Reproducibility</b>	≤ 5 mm
<b>Response time</b>	500 ms when covered / 1,000 ms when uncovered
<b>MTBF</b>	4,17*10 <sup>6</sup> h

#### Electronics

<b>Residual ripple</b>	≤ 5 V <sub>pp</sub>
<b>Power consumption</b>	< 10 mA
<b>Initialization time</b>	< 2 s
<b>VDE protection class 2</b>	✓
<b>Connection type</b>	M20 x 1.5
<b>Output signal</b>	1 x PNP/NPN
<b>Supply voltage</b>	Volt-free transistor output PNP/ NPN: 10 V DC ... 55 V DC
<b>Hysteresis</b>	10 mm
<b>Output current</b>	< 300 mA
<b>Inductive load</b>	1 H
<b>Capacitive load</b>	100 nF
<b>Enclosure rating</b>	IP66 / IP67

#### Mechanics

<b>Process connection</b>	G 1 A
<b>Housing material</b>	Plastic

<b>Sensor material</b>	Stainless steel 316L, 318S
------------------------	----------------------------

Ambient data

<b>Ambient operating temperature</b>	-40 °C ... +70 °C
<b>Ambient temperature, storage</b>	-40 °C ... +80 °C

Classifications

<b>ECLASS 5.0</b>	27273202
<b>ECLASS 5.1.4</b>	27273202
<b>ECLASS 6.0</b>	27273202
<b>ECLASS 6.2</b>	27273202
<b>ECLASS 7.0</b>	27273202
<b>ECLASS 8.0</b>	27273202
<b>ECLASS 8.1</b>	27273202
<b>ECLASS 9.0</b>	27273202
<b>ECLASS 10.0</b>	27273202
<b>ECLASS 11.0</b>	27273202
<b>ECLASS 12.0</b>	27273106
<b>ETIM 5.0</b>	EC002654
<b>ETIM 6.0</b>	EC002654
<b>ETIM 7.0</b>	EC002654
<b>ETIM 8.0</b>	EC002654
<b>UNSPSC 16.0901</b>	41111938

Type code

LBV331 type code

<b>Certification</b>	
XX	without
CX	ATEX II 1G, ½ G, 2G Ex ia IIC T6
CK	ATEX II 1G, ½ G, 2G Ex ia IIC T6 + 1D, 1/2D, 2D Ex tD IP66 T
LX	ATEX II ½ G, 2G Ex d IIC T6
LK	ATEX II ½ G, 2G Ex d IIC T6 + 1D, 1/2 D, 2D Ex tD IP66 T
GX	ATEX II 1D, ½ D, 2D Ex tD IP66 T
<b>Execution / Process temperature</b>	
A	Standard / -50 °C ... +150 °C
B	With spacer / -50 °C ... +250 °C
C	Detection of solids in water / -50 °C ... +150 °C
<b>Process connection / Material (see below)</b>	
<b>Electronics</b>	
C	Contact-free switch 20...253VAC(DC)
R	Relay (DPDT) 20...72VDC / 20...253VAC(3A)
T	Transistor (NPN/PNP) 10...55VDC
N	NAMUR signal
<b>Housing / Enclosure rating</b>	
K	Plastic / IP66, IP67
A	Aluminum / IP66, IP67
V	Stainless steel (investment casting) 316L / IP66, IP67
8	Stainless steel (electropolished) 316L / IP66, IP67
<b>Cable entry / Male connector connection</b>	
M	M20 x 1.5 / Without
N	½" NPT / Without
<b>Length 180 ... 6,000 mm</b>	

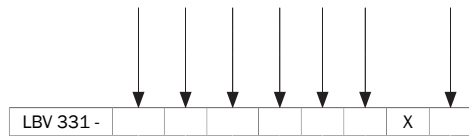

Not all variants of the type code can be combined!

### Process connection / Material

GC	Thread G 1 (DIN 3852-A) PN 16 / 316L	MF	Flange DN 100, PN 16, form C, DIN2501 / 316L
GR	Thread G 1 (DIN 3852-A) PN 16 / 316L,Ra< 0.8µm	OF	Flange DN 100, PN 40, form C, DIN2501 / 316L
GD	Thread G 1 ½ (DIN 3852-A) PN 16 / 316L	3F	Flange DN 125, PN 6, form C, DIN2501 / 316L
GT	Thread G 1 ½ (DIN 3852-A) PN 16 / 316L,Ra< 0.8µm	QF	Flange DN 150, PN 16, form C, DIN2501 / 316L
ND	Thread 1 ½" NPT (ASME B1.20.1) PN 16 / 316L	2F	Flange DN 200, PN 10, form C, DIN2501 / 316L
NT	Thread 1 ½" NPT (ASME B1.20.1) PN 16 / 316L,Ra< 0.8µm	EB	Flange DN 50, PN 40 EN1092-1 form B1 / 316L
CT	Tri-Clamp 1 ½" / 316L Ra< 0.8µm	DA	Flange 1 ½" 150 lb RF, ANSI B16.5 / 316L
CV	Tri-Clamp 2" / 316L Ra< 0.8µm	EA	Flange 1 ½" 300 lb RF, ANSI B16.5 / 316L
CQ	Tri-Clamp 2 ½" / 316L Ra< 0.8µm	HA	Flange 2" 150 lb RF, ANSI B16.5 / 316L
CM	Tri-Clamp 3 ½" / 316L Ra< 0.8µm	IA	Flange 2" 300 lb RF, ANSI B16.5 / 316L
RP	Pipe connection, DN 40, PN 40, DIN 11851 / 316L Ra< 0.8µm	OA	Flange 3" 150 lb RF, ANSI B16.5 / 316L
RF	Pipe connection, DN 40, PN 40, DIN 11864-1 form A / 316L Ra< 0.8µm	OE	Flange 3" 150 lb FF, ANSI B16.5 / 316L
RH	Pipe connection, DN 65, PN 25, DIN 11851 / 316L Ra< 0.8µm	PA	Flange 3" 300 lb RF, ANSI B16.5 / 316L
TV	Tuohenhagen Varivent, DN 32...1 ½" PN 25 / 316L Ra< 0.8µm	PE	Flange 3" 300 lb FF, ANSI B16.5 / 316L
C2	Bundle clamp, DN 40, PN 40, DIN,11864-3 form A / 316L Ra< 0.8µm	JA	Flange 3 ½" 150 lb RF, ANSI B16.5 / 316L
BF	Flange, DN 32, PN 40, form C, DIN 2501 / 316L	SA	Flange 4" 150 lb RF, ANSI B16.5 / 316L
DF	Flange, DN 40, PN 40, form C, DIN 2501 / 316L	UA	Flange 4" 300 lb RF, ANSI B16.5 / 316L
EF	Flange, DN 50, PN 40, form C, DIN 2501 / 316L	AU	Flange DN 50, 10K RF, JIS / 316L
4F	Flange, DN 65, PN 16, form C, DIN 2501 / 316L	HU	Flange DN 65, 10K RF, JIS / 316L
No error	Flange, DN 80, PN 40, form C, DIN 2501 / 316L	BU	Flange DN 80, 10K RF, JIS / 316L
ZF	Flange, DN 100, PN 6, form C, DIN 2501 / 316L	CU	Flange DN 100, 10K RF, JIS / 316L

Dimensional drawing (Dimensions in mm (inch))

LBV331 flange

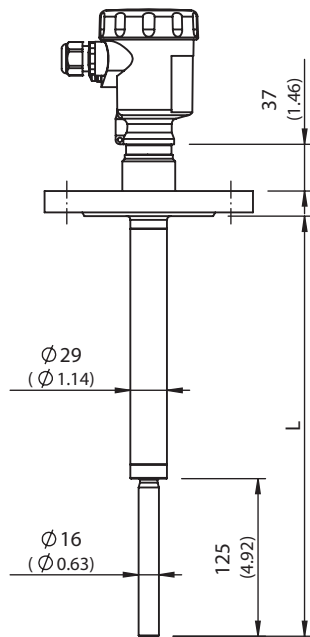

All dimensions in mm (inch)

LBV331 threaded version G 1 1/2 A

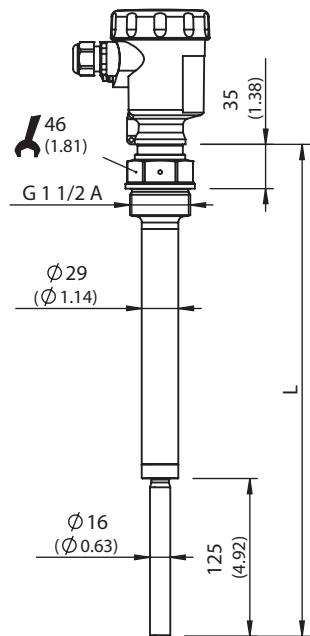

All dimensions in mm (inch)

LBV331 threaded version G 1 A



All dimensions in mm (inch)

### Connection diagram

PNP action

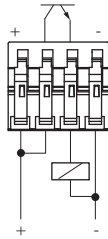

NPN action

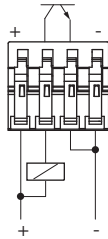

Transistor connection diagram

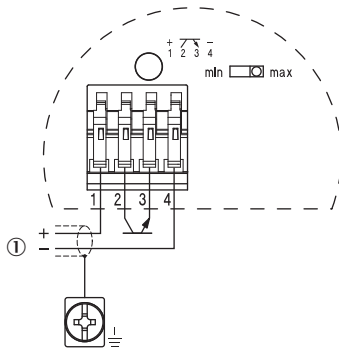

Instruction for installation

Horizontal mounting

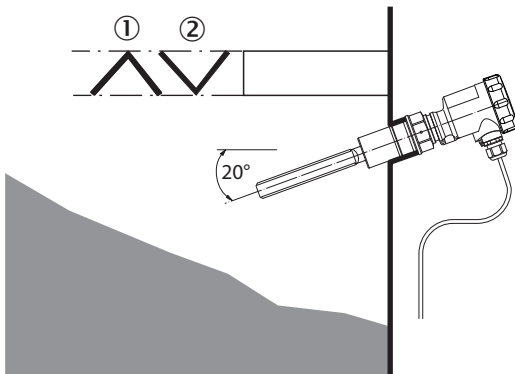

- ① Protective sheet
- ② Concave protective sheet for abrasive solids

Characteristic curve

Ambient temperature - process temperature

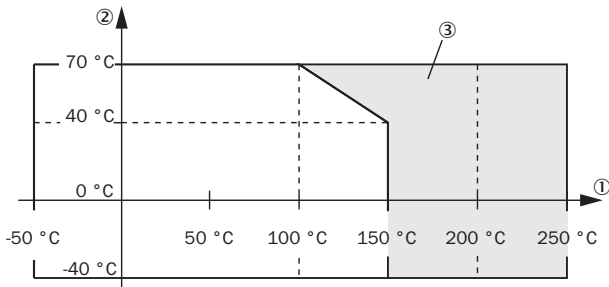

- ① Process temperature in °C (°F)
- ② Ambient temperature in °C (°F)
- ③ Temperature range with temperature adapter

## SICK AT A GLANCE

SICK is one of the leading manufacturers of intelligent sensors and sensor solutions for industrial applications. A unique range of products and services creates the perfect basis for controlling processes securely and efficiently, protecting individuals from accidents and preventing damage to the environment.

We have extensive experience in a wide range of industries and understand their processes and requirements. With intelligent sensors, we can deliver exactly what our customers need. In application centers in Europe, Asia and North America, system solutions are tested and optimized in accordance with customer specifications. All this makes us a reliable supplier and development partner.

Comprehensive services complete our offering: SICK LifeTime Services provide support throughout the machine life cycle and ensure safety and productivity.

For us, that is “Sensor Intelligence.”

## WORLDWIDE PRESENCE:

Contacts and other locations –[www.sick.com](http://www.sick.com)