



LFH-SW016G1AS30SZ0

LFH

PRESSURE SENSORS

SICK
Sensor Intelligence.



Illustration may differ



Ordering information

Type	Part no.
LFH-SW016G1AS30SZ0	6065916

Other models and accessories → www.sick.com/LFH

Detailed technical data

Features

Medium	Fluids
Pressure type	Gauge pressure
Pressure unit	mH2O
Measuring range	0 mH2O ... 16 mH2O
Process temperature	-10 °C ... +50 °C
Maximum ohmic load R_A	4 mA ... 20 mA, 2-wire, $R_A \leq (L^+ - 10 \text{ V}) / 0.02 \text{ A} - (0.14 \times \text{cable length in m})$ [Ohm] 0 V ... 10 V, 3-wire optional with enhanced variant, $R_A > 100 \text{ kOhm}$ 0 V ... 5 V, 3-wire optional with enhanced variant, $R_A > 100 \text{ kOhm}$
Output signal	4 mA ... 20 mA, 2-wire
Length of cable	30 m
Cable material	PUR

Mechanics/electronics

Wetted parts	Housing: Stainless steel Pressure connection/diaphragm: CrNi steel Protection cap: PA
Connection type	PUR cable
Supply voltage	10 V DC ... 30 V DC
Electrical safety	Protection class: III Short-circuit protection: Q_A towards M Reverse polarity protection: L^+ to M Surge protection: According to EN 61000-4-5 (1.5 J) optional for enhanced variant
Dielectric strength	500 V DC, NEC Class 02 power supply (low voltage and low current max. 100 VA even in the event of a fault)
CE-conformity	EMC directive: 2014/30/EU, EN 61 326-2-3
Weight sensor	0.18 kg
Cable weight	0.08 kg/m
Enclosure rating	IP68
Protection class III	✓
MTTF	403 years

Performance

Non-linearity	$\leq \pm 0.2 \%$, of span (Best Fit Straight Line, BFSL) according to IEC 61298-2
Accuracy	$\leq \pm 0.5 \%$ of the span
Non-repeatability	$\leq \pm 0.1 \%$ of the span
Long-term drift/one-year stability	$\leq \pm 0.2 \%$ of span (at reference conditions)
Temperature coefficient in rated temperature range	Mean TC of zero: $\leq 0.2 \%$ of span / 10 K ($< 0.4 \%$ for pressure ranges ≤ 0.25 bar) Mean TC of span $\leq 0.2 \%$ of span / 10 K
Rated temperature range	0 °C ... +50 °C

Ambient data

Storage temperature	-30 °C ... +80 °C
----------------------------	-------------------

Classifications

ECLASS 5.0	27200614
ECLASS 5.1.4	27200614
ECLASS 6.0	27200614
ECLASS 6.2	27200614
ECLASS 7.0	27200614
ECLASS 8.0	27200614
ECLASS 8.1	27200614
ECLASS 9.0	27200614
ECLASS 10.0	27200614
ECLASS 11.0	27200614
ECLASS 12.0	27200614
ETIM 5.0	EC011478
ETIM 6.0	EC011478
ETIM 7.0	EC011478
ETIM 8.0	EC011478
UNSPSC 16.0901	41111950



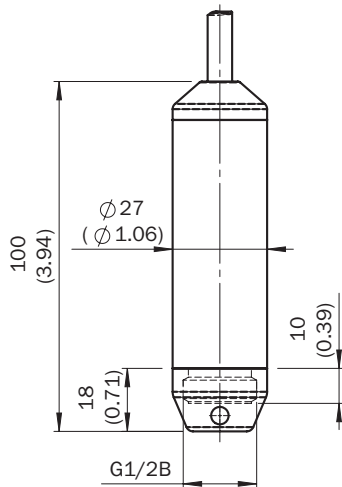

Dimensional drawing (Dimensions in mm (inch))

Standard version (Immersion depth up to 100 m)



Recommended accessories

Other models and accessories → www.sick.com/LFH

	Brief description	Type	Part no.
Other mounting accessories			
	Additional weight for stabilizing the LFH level sensor in moving liquids. Interior process connection G ½, is fastened to the level sensor instead of the protective cap. Weight: 500 g., Stainless steel 1.4571	BEF-AW-LFHSS-0001	5324308
Protection filter			
	Protection filter for connection cable. Prevents humidity from entering the ventilation tube of the connection cable. For self-mounting at cable end.	APR-VF-LFH001-0001	5324309
Terminal and alignment brackets			
	Cable tension clamp for mounting the connection cable of the level sensor, max. tensile load = 2.5 kN (not to be used with FEP cable), steel, zinc coated, plastic	BEF-CC-LFH001-0001	5324307
Others			
	<ul style="list-style-type: none"> Items supplied: With integrated pressure compensation and terminal block Note: Dimensions (W x D x H) 57 mm x 130 mm x 94 mm, for electrical connection of level probe LFH 	ASK-CB-LFH-PCO-0001	5324310

SICK AT A GLANCE

SICK is one of the leading manufacturers of intelligent sensors and sensor solutions for industrial applications. A unique range of products and services creates the perfect basis for controlling processes securely and efficiently, protecting individuals from accidents and preventing damage to the environment.

We have extensive experience in a wide range of industries and understand their processes and requirements. With intelligent sensors, we can deliver exactly what our customers need. In application centers in Europe, Asia and North America, system solutions are tested and optimized in accordance with customer specifications. All this makes us a reliable supplier and development partner.

Comprehensive services complete our offering: SICK LifeTime Services provide support throughout the machine life cycle and ensure safety and productivity.

For us, that is “Sensor Intelligence.”

WORLDWIDE PRESENCE:

Contacts and other locations –www.sick.com