



LFP0470-A4NMB

LFP Cubic

LEVEL SENSORS

SICK
Sensor Intelligence.



Illustration may differ



Ordering information

Type	Part no.
LFP0470-A4NMB	1108282

Other models and accessories → www.sick.com/LFP_Cubic

Detailed technical data

Features

Medium	Fluids
Measurement	Switch, Continuous
Design	Standard
Probe type	Rod probe
Probe length	470 mm
Process pressure	-1 bar ... 10 bar
Process temperature	-20 °C ... +100 °C
RoHS certificate	✓
IO-Link	✓
cULus certificate	✓

Performance

Accuracy of sensor element	± 5 mm ¹⁾
Reproducibility	≤ 2 mm
Resolution	< 2 mm
Response time	< 400 ms
Dielectricity constant	≥ 5 for rod probe / cable probe ≥ 1.8 with coaxial tube
Conductivity	No limitation
Maximum level change	≤ 500 mm/s
Deactivated area at process connection	25 mm ²⁾

¹⁾ With water under reference conditions.

²⁾ With parameterized container with water under reference conditions, otherwise 40 mm.

Deactivated area at end of probe	≥ 10 mm ¹⁾
MTTF	194.3 years (EN ISO 13849-1)
Display	✓

¹⁾ With water under reference conditions.

²⁾ With parameterized container with water under reference conditions, otherwise 40 mm.

Electronics

Communication interface	IO-Link
Supply voltage	12 V DC ... 30 V DC ¹⁾
Power consumption	≤ 100 mA at 24 V DC without output load
Initialization time	≤ 5 s
Protection class	III
Connection type	Round connector M12 x 1, 5-pin
Output signal	1 x PNP + 1 x PNP/NPN + 4 mA ... 20 mA / 0 V ... 10 V
Output load	4 mA ... 20 mA < 500 Ohm at U _v > 15 V, 4 mA ... 20 mA < 350 Ohm at U _v > 12 V, 0 V ... 10 V > 750 Ohm at U _v 14 ≥ V
Hysteresis	Min. 2 mm, free adjustable
Output current	< 100 mA
Inductive load	< 1 H
Capacitive load	100 nF
Enclosure rating	IP67: EN 60529
Temperature drift	< 0.1 mm/K
Lower signal level	3.8 mA ... 4 mA
Upper signal level	20 mA ... 20.5 mA
EMC	EN 61326-2-3, 2014/30/EU

¹⁾ All connections are polarity protected. All outputs are overload and short-circuit protected.

Mechanics

Wetted parts	1.4404, PTFE FKM
Process connection	G ¾ A
Housing material	Plastic PBT
Max. probe load	≤ 6 Nm

Ambient data

Ambient operating temperature	-20 °C ... +60 °C
Ambient temperature, storage	-40 °C ... +80 °C

Classifications

ECLASS 5.0	27200513
ECLASS 5.1.4	27200513
ECLASS 6.0	27200513
ECLASS 6.2	27200513
ECLASS 7.0	27200513
ECLASS 8.0	27200513

ECLASS 8.1	27200513
ECLASS 9.0	27200513
ECLASS 10.0	27200513
ECLASS 11.0	27200513
ECLASS 12.0	27200513
ETIM 5.0	EC001447
ETIM 6.0	EC001447
ETIM 7.0	EC001447
ETIM 8.0	EC001447
UNSPSC 16.0901	41113710

Type code

Type code

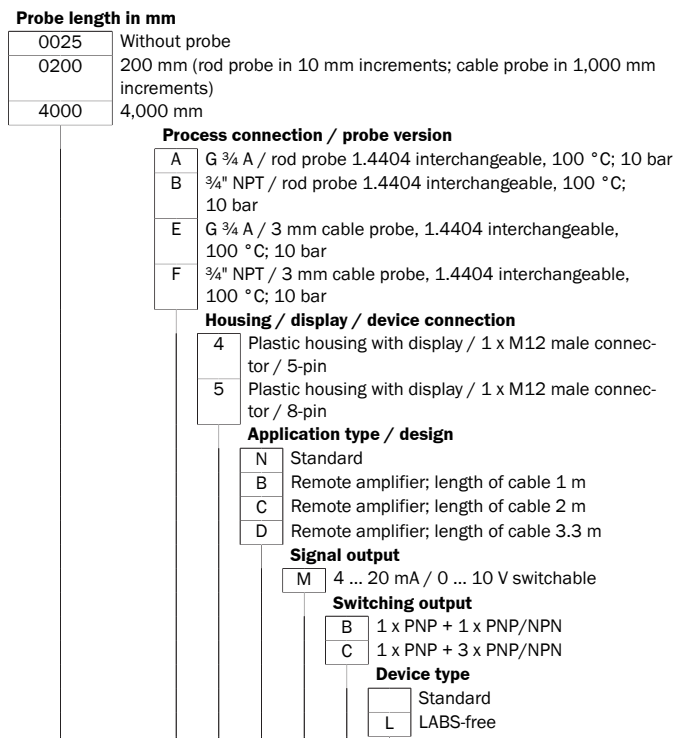

LFP - M

Not all variants of the type code can be combined!

Dependence between length of coaxial cable and probe length

Length of coaxial cable (mm)	Max. probe length (mm) foam mode deactivated	Max. probe length (mm) foam mode active
1000	4,000	2000
2000	3,000	1500
3300	1,000	500

Dimensional drawing (Dimensions in mm (inch))

Dimensional drawing: rod probe



- ① M: measuring range
- ② L: Probe length
- ③ IA: Inactive area at process connection 25 mm (0.98")
- ④ IAE: Inactive area at probe end 10 mm (0.39")

Connection type

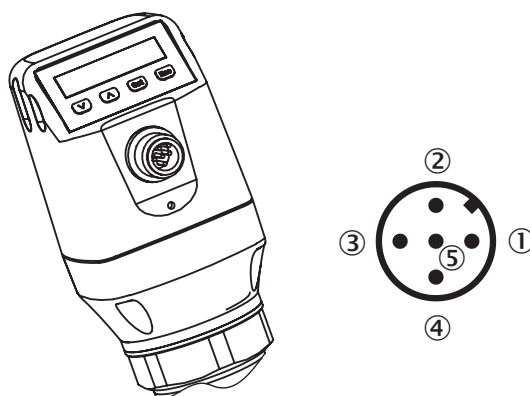

- ① L⁺: Supply voltage, brown
- ② Q_A: Analog current-/voltage output, white
- ③ M: Ground, reference ground for current-/voltage output, blue
- ④ C/Q₁: Switching output 1, PNP/IO-Link-communication, black
- ⑤ Q₂: Switching output 2, PNP/NPN, grey

Instruction for installation



Mono rod probe mounted in metal tank

M = Measuring range
 X = Inactive area at probe end
No measurement possible

Rope probe mounted in metal tank

Installation in nozzle:
 $D \geq \text{DN } 25$ (1")
Distance tank wall/tank bottom:
 $A \geq 50 \text{ mm}$ (1.97")
Distance to other tank fittings:
 $\geq 100 \text{ mm}$ (3.94")



Installation in a metal immersion tube or metal bypass



Installation in a metal tank



Unit with mono probe mounted in metal tank



Installation in nozzle:
 D \geq DN 25 (1")
 Distance tank wall/tank bottom:
 A \geq 50 mm (1.97")
 B \geq 10 mm (0.40")
 Distance to other tank fittings
 \geq 100mm (3.94")

Unit with coaxial tube for metal and non metal tank

C = with a coaxial tube there are no minimum distances to the tank wall or to other tank fittings required



Recommended accessories

Other models and accessories → www.sick.com/LFP_Cubic

	Brief description	Type	Part no.
Spare parts			
	Spare probe for LFP Cubic, probe length 1000 mm, material 1.4404/316L, diameter 7 mm	BEF-ER-SN1000-LFPC	2065700
	Spare probe for LFP Cubic, probe length 2000 mm, material 1.4404/316L, diameter 7 mm	BEF-ER-SN2000-LFPC	2065701
Device protection (mechanical)			
	Coaxial tube for LFP with process connection G 3/4, process connection of coaxial tube G 3/4, material 1.4571/316TI, for probe length 200 mm	LFPCT-0200G1	2068141
	Coaxial tube for LFP with process connection G 3/4, process connection of coaxial tube G 3/4, material 1.4571/316TI, for probe length 300 mm	LFPCT-0300G1	2068142

	Brief description	Type	Part no.
	Coaxial tube for LFP with process connection G 3/4, process connection of coaxial tube G 3/4, material 1.4571/316TI, for probe length 400 mm	LFPCT-0400G1	2068143
	Coaxial tube for LFP with process connection G 3/4, process connection of coaxial tube G 3/4, material 1.4571/316TI, for probe length 500 mm	LFPCT-0500G1	2068144
	Coaxial tube for LFP with process connection G 3/4, process connection of coaxial tube G 3/4, material 1.4571/316TI, for probe length 600 mm	LFPCT-0600G1	2068145
	Coaxial tube for LFP with process connection G 3/4, process connection of coaxial tube G 3/4, material 1.4571/316TI, for probe length 640 mm	LFPCT-0640G1	2087877
	Coaxial tube for LFP with process connection G 3/4, process connection of coaxial tube G 3/4, material 1.4571/316TI, for probe length 700 mm	LFPCT-0700G1	2068146
	Coaxial tube for LFP with process connection G 3/4, process connection of coax probe G 3/4, material 1.4571/316TI, for probe length 800 mm	LFPCT-0800G1	2068147
	Coaxial probe for LFP with process connection G 3/4, process connection of coaxial tube G 3/4, material 1.4571/316TI, for probe length 900 mm	LFPCT-0900G1	2067507
	Coaxial tube for LFP with process connection G 3/4, process connection of coaxial tube G 3/4, material 1.4571/316TI, for probe length 1000 mm	LFPCT-1000G1	2065702
	Coaxial tube for LFP with process connection G 3/4, process connection of coaxial tube G 3/4, material 1.4571/316TI, for probe length 1100 mm	LFPCT-1100G1	2068148
	Coaxial tube for LFP with process connection G 3/4, process connection of coaxial tube G 3/4, material 1.4571/316TI, for probe length 1200 mm	LFPCT-1200G1	2068149
	Coaxial tube for LFP with process connection G 3/4, process connection of coaxial tube G 3/4, material 1.4571/316TI, for probe length 1270 mm	LFPCT-1270G1	2142066
	Coaxial tube for LFP with process connection G 3/4, process connection of coaxial tube G 3/4, material 1.4571/316TI, for probe length 1300 mm	LFPCT-1300G1	2068150
	Coaxial tube for LFP with process connection G 3/4, process connection of coaxial tube G 3/4, material 1.4571/316TI, for probe length 1400 mm	LFPCT-1400G1	2068151
	Coaxial tube for LFP with process connection G 3/4, process connection of coaxial tube G 3/4, material 1.4571/316TI, for probe length 1500 mm	LFPCT-1500G1	2068152
	Coaxial tube for LFP with process connection G 3/4, process connection of coaxial tube G 3/4, material 1.4571/316TI, for probe length 1600 mm	LFPCT-1600G1	2068153
	Coaxial tube for LFP with process connection G 3/4, process connection of coaxial tube G 3/4, material 1.4571/316TI, for probe length 1700 mm	LFPCT-1700G1	2068154
	Coaxial tube for LFP with process connection G 3/4, process connection of coaxial tube G 3/4, material 1.4571/316TI, for probe length 1800 mm	LFPCT-1800G1	2068155
	Coaxial tube for LFP with process connection G 3/4, process connection of coax probe G 3/4, material 1.4571/316TI, for probe length 1900 mm	LFPCT-1900G1	2068156
	Coaxial tube for LFP with process connection G 3/4, process connection of coaxial tube G 3/4, material 1.4571/316TI, for probe length 2000 mm	LFPCT-2000G1	2065703
Flanges			
	Process connection adapter G 3/4 to G1	BEF-HA-G1BSP1-LFP1	2067603
	Weld-in flange G 3/4"	BEF-FL-GEWG34-LFP1	2082150
Mounting brackets and plates			
	Mounting bracket, stainless steel 1.4301 (AISI 304), mounting hardware included	BEF-FL-304LFP-HLDR	2077391

	Brief description	Type	Part no.
Others			
	<ul style="list-style-type: none"> • Connection type head A: Female connector, M12, 5-pin, angled, A-coded • Connection type head B: Flying leads • Signal type: Sensor/actuator cable • Cable: 2 m, 5-wire, PVC • Description: Sensor/actuator cable, unshielded • Application: Zones with chemicals, Uncontaminated zones 	YG2A15-020VB5XLEAX	2096215
	<ul style="list-style-type: none"> • Connection type head A: Female connector, M12, 5-pin, angled, A-coded • Connection type head B: Flying leads • Signal type: Sensor/actuator cable • Cable: 5 m, 5-wire, PVC • Description: Sensor/actuator cable, unshielded • Application: Zones with chemicals, Uncontaminated zones 	YG2A15-050VB5XLEAX	2096216
	<ul style="list-style-type: none"> • Connection type head A: Female connector, M12, 5-pin, angled, A-coded • Connection type head B: Flying leads • Signal type: Sensor/actuator cable • Cable: 10 m, 5-wire, PVC • Description: Sensor/actuator cable, unshielded • Application: Zones with chemicals, Uncontaminated zones 	YG2A15-100VB5XLEAX	2096217
	<ul style="list-style-type: none"> • Connection type head A: Female connector, M12, 5-pin, straight, A-coded • Connection type head B: Flying leads • Signal type: Sensor/actuator cable • Cable: 2 m, 5-wire, PUR, halogen-free • Description: Sensor/actuator cable, unshielded • Application: Uncontaminated zones, Zones with oils and lubricants, Robot, Drag chain operation 	YF2A15-020UB5XLEAX	2095617
	<ul style="list-style-type: none"> • Connection type head A: Female connector, M12, 5-pin, straight, A-coded • Connection type head B: Flying leads • Signal type: Sensor/actuator cable • Cable: 5 m, 5-wire, PUR, halogen-free • Description: Sensor/actuator cable, unshielded • Application: Uncontaminated zones, Zones with oils and lubricants, Robot, Drag chain operation 	YF2A15-050UB5XLEAX	2095618
	<ul style="list-style-type: none"> • Connection type head A: Female connector, M12, 5-pin, straight, A-coded • Connection type head B: Flying leads • Signal type: Sensor/actuator cable • Cable: 10 m, 5-wire, PUR, halogen-free • Description: Sensor/actuator cable, unshielded • Application: Uncontaminated zones, Zones with oils and lubricants, Robot, Drag chain operation 	YF2A15-100UB5XLEAX	2095619
	<ul style="list-style-type: none"> • Connection type head A: Female connector, M12, 5-pin, angled, A-coded • Connection type head B: Flying leads • Signal type: Sensor/actuator cable • Cable: 2 m, 5-wire, PUR, halogen-free • Description: Sensor/actuator cable, unshielded • Application: Uncontaminated zones, Zones with oils and lubricants, Robot, Drag chain operation 	YG2A15-020UB5XLEAX	2095772
	<ul style="list-style-type: none"> • Connection type head A: Female connector, M12, 5-pin, angled, A-coded • Connection type head B: Flying leads • Signal type: Sensor/actuator cable • Cable: 5 m, 5-wire, PUR, halogen-free • Description: Sensor/actuator cable, unshielded • Application: Uncontaminated zones, Zones with oils and lubricants, Robot, Drag chain operation 	YG2A15-050UB5XLEAX	2095773
	<ul style="list-style-type: none"> • Connection type head A: Female connector, M12, 5-pin, angled, A-coded • Connection type head B: Flying leads • Signal type: Sensor/actuator cable • Cable: 10 m, 5-wire, PUR, halogen-free • Description: Sensor/actuator cable, unshielded • Application: Uncontaminated zones, Zones with oils and lubricants, Robot, Drag chain operation 	YG2A15-100UB5XLEAX	2095774

	Brief description	Type	Part no.
	<ul style="list-style-type: none"> • Connection type head A: Female connector, M12, 5-pin, straight, A-coded • Connection type head B: Flying leads • Signal type: Sensor/actuator cable • Cable: 2 m, 5-wire, PVC • Description: Sensor/actuator cable, unshielded • Application: Zones with chemicals, Uncontaminated zones 	YF2A15-020VB5XLEAX	2096239
	<ul style="list-style-type: none"> • Connection type head A: Female connector, M12, 5-pin, straight, A-coded • Connection type head B: Flying leads • Signal type: Sensor/actuator cable • Cable: 5 m, 5-wire, PVC • Description: Sensor/actuator cable, unshielded • Application: Zones with chemicals, Uncontaminated zones 	YF2A15-050VB5XLEAX	2096240
	<ul style="list-style-type: none"> • Connection type head A: Female connector, M12, 5-pin, straight, A-coded • Connection type head B: Flying leads • Signal type: Sensor/actuator cable • Cable: 10 m, 5-wire, PVC • Description: Sensor/actuator cable, unshielded • Application: Zones with chemicals, Uncontaminated zones 	YF2A15-100VB5XLEAX	2096241

Recommended services

Additional services → www.sick.com/LFP_Cubic

	Type	Part no.
Function Block Factory		
<ul style="list-style-type: none"> • Description: The Function Block Factory is an engineering tool for creating device and environment-specific function blocks that enable IO-Link sensors to be integrated into programmable logic controllers. The Function Block Factory supports common programmable logic controllers (PLCs) of various manufacturers such as Siemens, Beckhoff, Rockwell Automation B&R and more. More information on the FBF can be found here. • Provision: Customers can obtain access to the Function Block Factory and the license via https://fbf.cloud.sick.com. 	Function Block Factory	On request

SICK AT A GLANCE

SICK is one of the leading manufacturers of intelligent sensors and sensor solutions for industrial applications. A unique range of products and services creates the perfect basis for controlling processes securely and efficiently, protecting individuals from accidents and preventing damage to the environment.

We have extensive experience in a wide range of industries and understand their processes and requirements. With intelligent sensors, we can deliver exactly what our customers need. In application centers in Europe, Asia and North America, system solutions are tested and optimized in accordance with customer specifications. All this makes us a reliable supplier and development partner.

Comprehensive services complete our offering: SICK LifeTime Services provide support throughout the machine life cycle and ensure safety and productivity.

For us, that is “Sensor Intelligence.”

WORLDWIDE PRESENCE:

Contacts and other locations –www.sick.com