



# LFP1600-A4NMB

LFP Cubic

LEVEL SENSORS

**SICK**  
Sensor Intelligence.



Illustration may differ



### Ordering information

Type	Part no.
LFP1600-A4NMB	1057087

Other models and accessories → [www.sick.com/LFP\\_Cubic](http://www.sick.com/LFP_Cubic)

### Detailed technical data

#### Features

<b>Medium</b>	Fluids
<b>Measurement</b>	Switch, Continuous
<b>Design</b>	Standard
<b>Probe type</b>	Rod probe
<b>Probe length</b>	1,600 mm
<b>Process pressure</b>	-1 bar ... 10 bar
<b>Process temperature</b>	-20 °C ... +100 °C
<b>RoHS certificate</b>	✓
<b>IO-Link</b>	✓
<b>cULus certificate</b>	✓

#### Performance

<b>Accuracy of sensor element</b>	± 5 mm <sup>1)</sup>
<b>Reproducibility</b>	≤ 2 mm
<b>Resolution</b>	< 2 mm
<b>Response time</b>	< 400 ms
<b>Dielectricity constant</b>	≥ 5 for rod probe / cable probe ≥ 1.8 with coaxial tube
<b>Conductivity</b>	No limitation
<b>Maximum level change</b>	≤ 500 mm/s
<b>Deactivated area at process connection</b>	25 mm <sup>2)</sup>

<sup>1)</sup> With water under reference conditions.

<sup>2)</sup> With parameterized container with water under reference conditions, otherwise 40 mm.

<b>Deactivated area at end of probe</b>	≥ 10 mm <sup>1)</sup>
<b>MTTF</b>	194.3 years (EN ISO 13849-1)
<b>Display</b>	✓

<sup>1)</sup> With water under reference conditions.

<sup>2)</sup> With parameterized container with water under reference conditions, otherwise 40 mm.

## Electronics

<b>Communication interface</b>	IO-Link
<b>Supply voltage</b>	12 V DC ... 30 V DC <sup>1)</sup>
<b>Power consumption</b>	≤ 100 mA at 24 V DC without output load
<b>Initialization time</b>	≤ 5 s
<b>Protection class</b>	III
<b>Connection type</b>	Round connector M12 x 1, 5-pin
<b>Output signal</b>	1 x PNP + 1 x PNP/NPN + 4 mA ... 20 mA / 0 V ... 10 V
<b>Output load</b>	4 mA ... 20 mA < 500 Ohm at U <sub>v</sub> > 15 V, 4 mA ... 20 mA < 350 Ohm at U <sub>v</sub> > 12 V, 0 V ... 10 V > 750 Ohm at U <sub>v</sub> 14 ≥ V
<b>Hysteresis</b>	Min. 2 mm, free adjustable
<b>Output current</b>	< 100 mA
<b>Inductive load</b>	< 1 H
<b>Capacitive load</b>	100 nF
<b>Enclosure rating</b>	IP67: EN 60529
<b>Temperature drift</b>	< 0.1 mm/K
<b>Lower signal level</b>	3.8 mA ... 4 mA
<b>Upper signal level</b>	20 mA ... 20.5 mA
<b>EMC</b>	EN 61326-2-3, 2014/30/EU

<sup>1)</sup> All connections are polarity protected. All outputs are overload and short-circuit protected.

## Mechanics

<b>Wetted parts</b>	1.4404, PTFE FKM
<b>Process connection</b>	G ¾ A
<b>Housing material</b>	Plastic PBT
<b>Max. probe load</b>	≤ 6 Nm

## Ambient data

<b>Ambient operating temperature</b>	-20 °C ... +60 °C
<b>Ambient temperature, storage</b>	-40 °C ... +80 °C

## Classifications

<b>ECLASS 5.0</b>	27200513
<b>ECLASS 5.1.4</b>	27200513
<b>ECLASS 6.0</b>	27200513
<b>ECLASS 6.2</b>	27200513
<b>ECLASS 7.0</b>	27200513
<b>ECLASS 8.0</b>	27200513

<b>ECLASS 8.1</b>	27200513
<b>ECLASS 9.0</b>	27200513
<b>ECLASS 10.0</b>	27200513
<b>ECLASS 11.0</b>	27200513
<b>ECLASS 12.0</b>	27200513
<b>ETIM 5.0</b>	EC001447
<b>ETIM 6.0</b>	EC001447
<b>ETIM 7.0</b>	EC001447
<b>ETIM 8.0</b>	EC001447
<b>UNSPSC 16.0901</b>	41113710

### Type code

Type code



Not all variants of the type code can be combined!

Dependence between length of coaxial cable and probe length

Length of coaxial cable (mm)	Max. probe length (mm) foam mode deactivated	Max. probe length (mm) foam mode active
1000	4,000	2000
2000	3,000	1500
3300	1,000	500

Dimensional drawing (Dimensions in mm (inch))

Dimensional drawing: rod probe



- ① M: measuring range
- ② L: Probe length
- ③ IA: Inactive area at process connection 25 mm (0.98")
- ④ IAE: Inactive area at probe end 10 mm (0.39")

Connection type



- ① L<sup>+</sup>: Supply voltage, brown
- ② Q<sub>A</sub>: Analog current-/voltage output, white
- ③ M: Ground, reference ground for current-/voltage output, blue
- ④ C/Q<sub>1</sub>: Switching output 1, PNP/IO-Link-communication, black
- ⑤ Q<sub>2</sub>: Switching output 2, PNP/NPN, grey

### Instruction for installation



#### Mono rod probe mounted in metal tank

$M$  = Measuring range  
 $X$  = Inactive area at probe end  
 No measurement possible

#### Rope probe mounted in metal tank

Installation in nozzle:  
 $D \geq \text{DN } 25$  (1")  
 Distance tank wall/tank bottom:  
 $A \geq 50 \text{ mm}$  (1.97")  
 Distance to other tank fittings:  
 $\geq 100 \text{ mm}$  (3.94")



Installation in a metal immersion tube or metal bypass

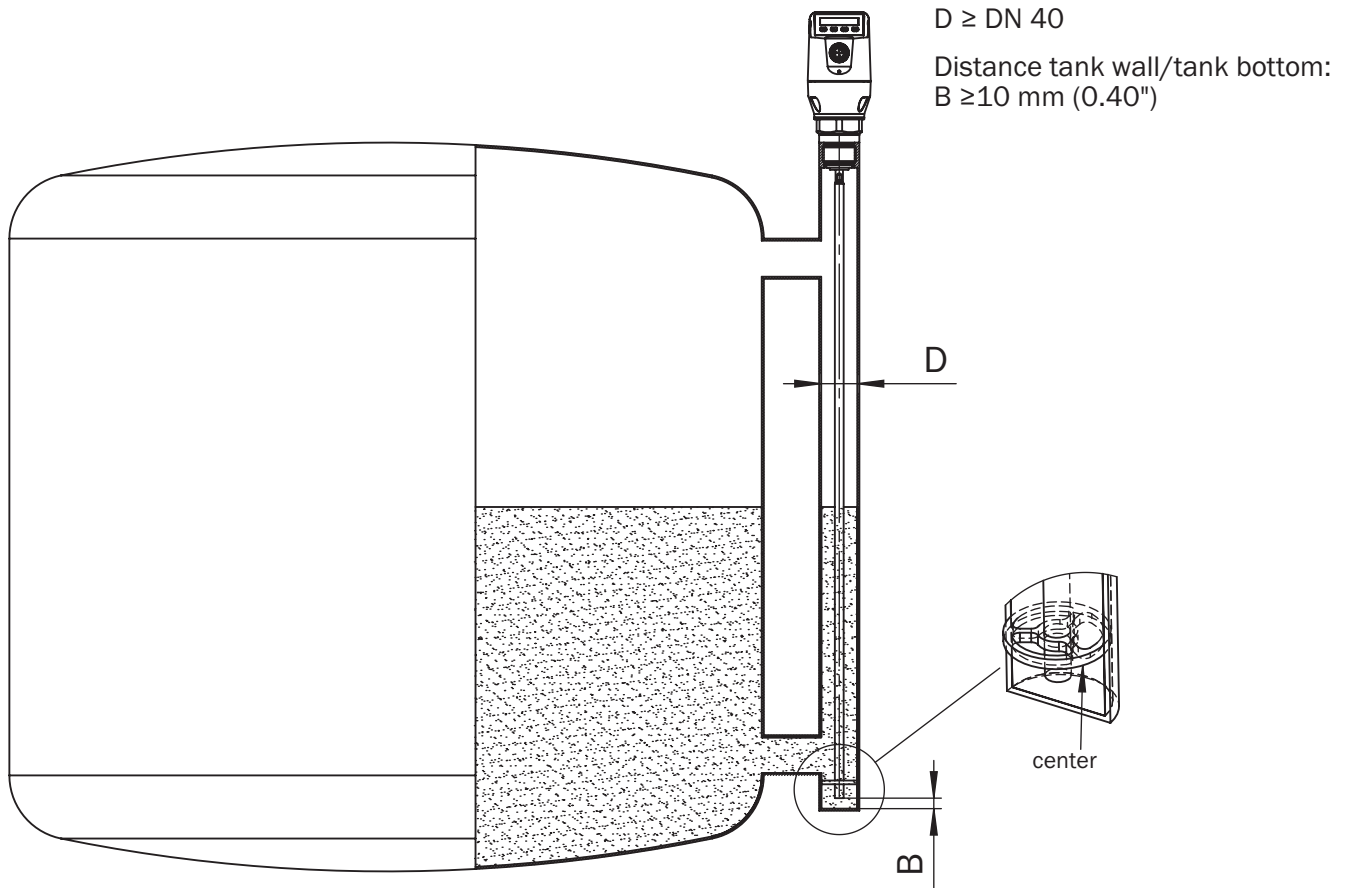

Installation in a metal tank



Unit with mono probe mounted in metal tank





Installation in nozzle:  
 D  $\geq$  DN 25 (1")  
 Distance tank wall/tank bottom:  
 A  $\geq$  50 mm (1.97")  
 B  $\geq$  10 mm (0.40")  
 Distance to other tank fittings  
 $\geq$  100mm (3.94")

Unit with coaxial tube for metal and non metal tank

C = with a coaxial tube there are no minimum distances to the tank wall or to other tank fittings required

### Recommended accessories



Other models and accessories → [www.sick.com/LFP\\_Cubic](http://www.sick.com/LFP_Cubic)

	Brief description	Type	Part no.
<b>Spare parts</b>			
	Spare probe for LFP Cubic, probe length 1000 mm, material 1.4404/316L, diameter 7 mm	BEF-ER-SN1000-LFPC	2065700
	Spare probe for LFP Cubic, probe length 2000 mm, material 1.4404/316L, diameter 7 mm	BEF-ER-SN2000-LFPC	2065701
<b>Device protection (mechanical)</b>			
	Coaxial tube for LFP with process connection G 3/4, process connection of coaxial tube G 3/4, material 1.4571/316TI, for probe length 200 mm	LFPCT-0200G1	2068141
	Coaxial tube for LFP with process connection G 3/4, process connection of coaxial tube G 3/4, material 1.4571/316TI, for probe length 300 mm	LFPCT-0300G1	2068142



	Brief description	Type	Part no.
	Coaxial tube for LFP with process connection G 3/4, process connection of coaxial tube G 3/4, material 1.4571/316TI, for probe length 400 mm	LFPCT-0400G1	2068143
	Coaxial tube for LFP with process connection G 3/4, process connection of coaxial tube G 3/4, material 1.4571/316TI, for probe length 500 mm	LFPCT-0500G1	2068144
	Coaxial tube for LFP with process connection G 3/4, process connection of coaxial tube G 3/4, material 1.4571/316TI, for probe length 600 mm	LFPCT-0600G1	2068145
	Coaxial tube for LFP with process connection G 3/4, process connection of coaxial tube G 3/4, material 1.4571/316TI, for probe length 640 mm	LFPCT-0640G1	2087877
	Coaxial tube for LFP with process connection G 3/4, process connection of coaxial tube G 3/4, material 1.4571/316TI, for probe length 700 mm	LFPCT-0700G1	2068146
	Coaxial tube for LFP with process connection G 3/4, process connection of coax probe G 3/4, material 1.4571/316TI, for probe length 800 mm	LFPCT-0800G1	2068147
	Coaxial probe for LFP with process connection G 3/4, process connection of coaxial tube G 3/4, material 1.4571/316TI, for probe length 900 mm	LFPCT-0900G1	2067507
	Coaxial tube for LFP with process connection G 3/4, process connection of coaxial tube G 3/4, material 1.4571/316TI, for probe length 1000 mm	LFPCT-1000G1	2065702
	Coaxial tube for LFP with process connection G 3/4, process connection of coaxial tube G 3/4, material 1.4571/316TI, for probe length 1100 mm	LFPCT-1100G1	2068148
	Coaxial tube for LFP with process connection G 3/4, process connection of coaxial tube G 3/4, material 1.4571/316TI, for probe length 1200 mm	LFPCT-1200G1	2068149
	Coaxial tube for LFP with process connection G 3/4, process connection of coaxial tube G 3/4, material 1.4571/316TI, for probe length 1270 mm	LFPCT-1270G1	2142066
	Coaxial tube for LFP with process connection G 3/4, process connection of coaxial tube G 3/4, material 1.4571/316TI, for probe length 1300 mm	LFPCT-1300G1	2068150
	Coaxial tube for LFP with process connection G 3/4, process connection of coaxial tube G 3/4, material 1.4571/316TI, for probe length 1400 mm	LFPCT-1400G1	2068151
	Coaxial tube for LFP with process connection G 3/4, process connection of coaxial tube G 3/4, material 1.4571/316TI, for probe length 1500 mm	LFPCT-1500G1	2068152
	Coaxial tube for LFP with process connection G 3/4, process connection of coaxial tube G 3/4, material 1.4571/316TI, for probe length 1600 mm	LFPCT-1600G1	2068153
	Coaxial tube for LFP with process connection G 3/4, process connection of coaxial tube G 3/4, material 1.4571/316TI, for probe length 1700 mm	LFPCT-1700G1	2068154
	Coaxial tube for LFP with process connection G 3/4, process connection of coaxial tube G 3/4, material 1.4571/316TI, for probe length 1800 mm	LFPCT-1800G1	2068155
	Coaxial tube for LFP with process connection G 3/4, process connection of coax probe G 3/4, material 1.4571/316TI, for probe length 1900 mm	LFPCT-1900G1	2068156
	Coaxial tube for LFP with process connection G 3/4, process connection of coaxial tube G 3/4, material 1.4571/316TI, for probe length 2000 mm	LFPCT-2000G1	2065703
<b>Flanges</b>			
	Process connection adapter G 3/4 to G1	BEF-HA-G1BSP1-LFP1	2067603
	Weld-in flange G 3/4"	BEF-FL-GEWG34-LFP1	2082150
<b>Mounting brackets and plates</b>			
	Mounting bracket, stainless steel 1.4301 (AISI 304), mounting hardware included	BEF-FL-304LFP-HLDR	2077391

	Brief description	Type	Part no.
Others			
	<ul style="list-style-type: none"> <li>• <b>Connection type head A:</b> Female connector, M12, 5-pin, angled, A-coded</li> <li>• <b>Connection type head B:</b> Flying leads</li> <li>• <b>Signal type:</b> Sensor/actuator cable</li> <li>• <b>Cable:</b> 2 m, 5-wire, PVC</li> <li>• <b>Description:</b> Sensor/actuator cable, unshielded</li> <li>• <b>Application:</b> Zones with chemicals, Uncontaminated zones</li> </ul>	YG2A15-020VB5XLEAX	2096215
	<ul style="list-style-type: none"> <li>• <b>Connection type head A:</b> Female connector, M12, 5-pin, angled, A-coded</li> <li>• <b>Connection type head B:</b> Flying leads</li> <li>• <b>Signal type:</b> Sensor/actuator cable</li> <li>• <b>Cable:</b> 5 m, 5-wire, PVC</li> <li>• <b>Description:</b> Sensor/actuator cable, unshielded</li> <li>• <b>Application:</b> Zones with chemicals, Uncontaminated zones</li> </ul>	YG2A15-050VB5XLEAX	2096216
	<ul style="list-style-type: none"> <li>• <b>Connection type head A:</b> Female connector, M12, 5-pin, angled, A-coded</li> <li>• <b>Connection type head B:</b> Flying leads</li> <li>• <b>Signal type:</b> Sensor/actuator cable</li> <li>• <b>Cable:</b> 10 m, 5-wire, PVC</li> <li>• <b>Description:</b> Sensor/actuator cable, unshielded</li> <li>• <b>Application:</b> Zones with chemicals, Uncontaminated zones</li> </ul>	YG2A15-100VB5XLEAX	2096217
	<ul style="list-style-type: none"> <li>• <b>Connection type head A:</b> Female connector, M12, 5-pin, straight, A-coded</li> <li>• <b>Connection type head B:</b> Flying leads</li> <li>• <b>Signal type:</b> Sensor/actuator cable</li> <li>• <b>Cable:</b> 2 m, 5-wire, PUR, halogen-free</li> <li>• <b>Description:</b> Sensor/actuator cable, unshielded</li> <li>• <b>Application:</b> Uncontaminated zones, Zones with oils and lubricants, Robot, Drag chain operation</li> </ul>	YF2A15-020UB5XLEAX	2095617
	<ul style="list-style-type: none"> <li>• <b>Connection type head A:</b> Female connector, M12, 5-pin, straight, A-coded</li> <li>• <b>Connection type head B:</b> Flying leads</li> <li>• <b>Signal type:</b> Sensor/actuator cable</li> <li>• <b>Cable:</b> 5 m, 5-wire, PUR, halogen-free</li> <li>• <b>Description:</b> Sensor/actuator cable, unshielded</li> <li>• <b>Application:</b> Uncontaminated zones, Zones with oils and lubricants, Robot, Drag chain operation</li> </ul>	YF2A15-050UB5XLEAX	2095618
	<ul style="list-style-type: none"> <li>• <b>Connection type head A:</b> Female connector, M12, 5-pin, straight, A-coded</li> <li>• <b>Connection type head B:</b> Flying leads</li> <li>• <b>Signal type:</b> Sensor/actuator cable</li> <li>• <b>Cable:</b> 10 m, 5-wire, PUR, halogen-free</li> <li>• <b>Description:</b> Sensor/actuator cable, unshielded</li> <li>• <b>Application:</b> Uncontaminated zones, Zones with oils and lubricants, Robot, Drag chain operation</li> </ul>	YF2A15-100UB5XLEAX	2095619
	<ul style="list-style-type: none"> <li>• <b>Connection type head A:</b> Female connector, M12, 5-pin, angled, A-coded</li> <li>• <b>Connection type head B:</b> Flying leads</li> <li>• <b>Signal type:</b> Sensor/actuator cable</li> <li>• <b>Cable:</b> 2 m, 5-wire, PUR, halogen-free</li> <li>• <b>Description:</b> Sensor/actuator cable, unshielded</li> <li>• <b>Application:</b> Uncontaminated zones, Zones with oils and lubricants, Robot, Drag chain operation</li> </ul>	YG2A15-020UB5XLEAX	2095772
	<ul style="list-style-type: none"> <li>• <b>Connection type head A:</b> Female connector, M12, 5-pin, angled, A-coded</li> <li>• <b>Connection type head B:</b> Flying leads</li> <li>• <b>Signal type:</b> Sensor/actuator cable</li> <li>• <b>Cable:</b> 5 m, 5-wire, PUR, halogen-free</li> <li>• <b>Description:</b> Sensor/actuator cable, unshielded</li> <li>• <b>Application:</b> Uncontaminated zones, Zones with oils and lubricants, Robot, Drag chain operation</li> </ul>	YG2A15-050UB5XLEAX	2095773
	<ul style="list-style-type: none"> <li>• <b>Connection type head A:</b> Female connector, M12, 5-pin, angled, A-coded</li> <li>• <b>Connection type head B:</b> Flying leads</li> <li>• <b>Signal type:</b> Sensor/actuator cable</li> <li>• <b>Cable:</b> 10 m, 5-wire, PUR, halogen-free</li> <li>• <b>Description:</b> Sensor/actuator cable, unshielded</li> <li>• <b>Application:</b> Uncontaminated zones, Zones with oils and lubricants, Robot, Drag chain operation</li> </ul>	YG2A15-100UB5XLEAX	2095774

	Brief description	Type	Part no.
	<ul style="list-style-type: none"> <li>• <b>Connection type head A:</b> Female connector, M12, 5-pin, straight, A-coded</li> <li>• <b>Connection type head B:</b> Flying leads</li> <li>• <b>Signal type:</b> Sensor/actuator cable</li> <li>• <b>Cable:</b> 2 m, 5-wire, PVC</li> <li>• <b>Description:</b> Sensor/actuator cable, unshielded</li> <li>• <b>Application:</b> Zones with chemicals, Uncontaminated zones</li> </ul>	YF2A15-020VB5XLEAX	2096239
	<ul style="list-style-type: none"> <li>• <b>Connection type head A:</b> Female connector, M12, 5-pin, straight, A-coded</li> <li>• <b>Connection type head B:</b> Flying leads</li> <li>• <b>Signal type:</b> Sensor/actuator cable</li> <li>• <b>Cable:</b> 5 m, 5-wire, PVC</li> <li>• <b>Description:</b> Sensor/actuator cable, unshielded</li> <li>• <b>Application:</b> Zones with chemicals, Uncontaminated zones</li> </ul>	YF2A15-050VB5XLEAX	2096240
	<ul style="list-style-type: none"> <li>• <b>Connection type head A:</b> Female connector, M12, 5-pin, straight, A-coded</li> <li>• <b>Connection type head B:</b> Flying leads</li> <li>• <b>Signal type:</b> Sensor/actuator cable</li> <li>• <b>Cable:</b> 10 m, 5-wire, PVC</li> <li>• <b>Description:</b> Sensor/actuator cable, unshielded</li> <li>• <b>Application:</b> Zones with chemicals, Uncontaminated zones</li> </ul>	YF2A15-100VB5XLEAX	2096241

## Recommended services

Additional services → [www.sick.com/LFP\\_Cubic](http://www.sick.com/LFP_Cubic)

	Type	Part no.
Function Block Factory		
<ul style="list-style-type: none"> <li>• <b>Description:</b> The Function Block Factory is an engineering tool for creating device and environment-specific function blocks that enable IO-Link sensors to be integrated into programmable logic controllers. The Function Block Factory supports common programmable logic controllers (PLCs) of various manufacturers such as Siemens, Beckhoff, Rockwell Automation B&amp;R and more. More information on the FBF can be found <a href="https://fbf.cloud.sick.com" target="_blank">here</a>.</li> <li>• <b>Provision:</b> Customers can obtain access to the Function Block Factory and the license via <a href="https://fbf.cloud.sick.com" target="_blank">https://fbf.cloud.sick.com</a>.</li> </ul>	Function Block Factory	On request

## SICK AT A GLANCE

SICK is one of the leading manufacturers of intelligent sensors and sensor solutions for industrial applications. A unique range of products and services creates the perfect basis for controlling processes securely and efficiently, protecting individuals from accidents and preventing damage to the environment.

We have extensive experience in a wide range of industries and understand their processes and requirements. With intelligent sensors, we can deliver exactly what our customers need. In application centers in Europe, Asia and North America, system solutions are tested and optimized in accordance with customer specifications. All this makes us a reliable supplier and development partner.

Comprehensive services complete our offering: SICK LifeTime Services provide support throughout the machine life cycle and ensure safety and productivity.

For us, that is “Sensor Intelligence.”

## WORLDWIDE PRESENCE:

Contacts and other locations –[www.sick.com](http://www.sick.com)