



# LFV230-XASGBTPM0250

LFV200

LEVEL SENSORS

**SICK**  
Sensor Intelligence.



Illustration may differ



### Ordering information

Type	Part no.
LFV230-XASGBTPM0250	6064022

Other models and accessories → [www.sick.com/LFV200](http://www.sick.com/LFV200)

### Detailed technical data

#### Features

<b>Medium</b>	Fluids
<b>Measurement</b>	Switch
<b>Probe length</b>	250 mm
<b>Process pressure</b>	-1 bar ... 64 bar
<b>Process temperature</b>	-40 °C ... +100 °C
<b>Fill material density</b>	0.7 g/cm <sup>3</sup> ... 2.5 g/cm <sup>3</sup>
<b>WHG approval</b>	✓
<b>Authorizations</b>	WHG approval

#### Performance

<b>Accuracy of sensor element</b>	± 2 mm
<b>Reproducibility</b>	≤ 1 mm
<b>Viscosity</b>	0.1 mPas ... 10,000 mPas
<b>Resolution</b>	≤ 1 mm
<b>Response time</b>	500 ms
<b>MTBF</b>	1,25*10 <sup>7</sup> h

#### Electronics

<b>Supply voltage</b>	9.6 V DC ... 35 V DC
<b>Residual ripple</b>	≤ 5 V <sub>pp</sub>
<b>Power consumption</b>	< 10 mA
<b>Initialization time</b>	< 2 s
<b>VDE protection class 2</b>	✓
<b>Connection type</b>	M12 round connector x 1, 4-pin
<b>Output signal</b>	Transistor output PNP
<b>Hysteresis</b>	2 mm
<b>Output current</b>	< 250 mA
<b>Inductive load</b>	≤ 1 H
<b>Capacitive load</b>	100 nF

<b>Enclosure rating</b>	IP67
<b>Temperature drift</b>	0.03 mm/K

Mechanics

<b>Wetted parts</b>	Stainless steel 1.4404
<b>Process connection</b>	G ¾ A PN 64
<b>Housing material</b>	Stainless steel 1.4404, PEI

Ambient data

<b>Ambient operating temperature</b>	-40 °C ... +70 °C
<b>Ambient temperature, storage</b>	-40 °C ... +80 °C

Classifications

<b>ECLASS 5.0</b>	27273202
<b>ECLASS 5.1.4</b>	27273202
<b>ECLASS 6.0</b>	27273202
<b>ECLASS 6.2</b>	27273202
<b>ECLASS 7.0</b>	27273202
<b>ECLASS 8.0</b>	27273202
<b>ECLASS 8.1</b>	27273202
<b>ECLASS 9.0</b>	27273202
<b>ECLASS 10.0</b>	27273202
<b>ECLASS 11.0</b>	27273202
<b>ECLASS 12.0</b>	27273106
<b>ETIM 5.0</b>	EC002654
<b>ETIM 6.0</b>	EC002654
<b>ETIM 7.0</b>	EC002654
<b>ETIM 8.0</b>	EC002654
<b>UNSPSC 16.0901</b>	41111938

Type code

LFV230 type code

<b>Certification</b>	
XX	without
XA	Overfill protection in acc. with WHG (German Federal Water Act)
<b>Execution / Process temperature</b>	
S	Standard / -40 °C ... +100 °C
T	Expanded / -40 °C ... +150 °C
H	Hygiene applications / -40 °C ... +150 °C
<b>Process connection / Material</b>	
GB	G ¾ A, PN 64 / 316L
NB	¾" NPT, PN 64 / 316L
GA	G 1 A, PN 64 / 316L
NA	1" NPT, PN 64 / 316L
CL	Tri-clamp 1", PN 16, L, Ra < 0.8 µm
CN	Tri-clamp 2", PN 16, L, Ra < 0.8 µm
RL	Conical adapter DN 25, DIN 11851 with coupling nut PN 40 / 316L, Ra < 0.8 µm
RM	Conical adapter DN 40, DIN 11851 with coupling nut PN 40 / 316L, Ra < 0.8 µm

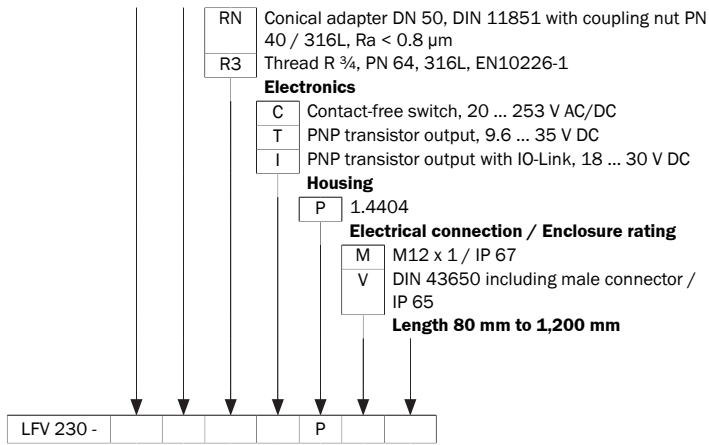

Not all variants of the type code can be combined!

[Dimensional drawing](#) (Dimensions in mm (inch))

Dimensional drawing process connection

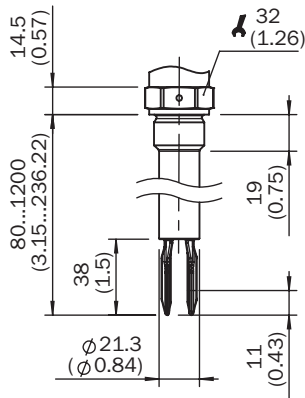



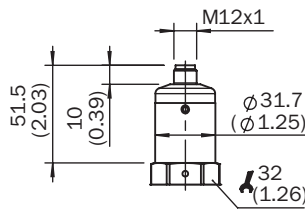

Dimensional drawing housing



### Recommended accessories

Other models and accessories → [www.sick.com/LFV200](http://www.sick.com/LFV200)

	Brief description	Type	Part no.
<b>Flanges</b>			
	Welded flange/welded connector, DIN11851-1, DN25 / PN40, Stainless steel 1.4404	BEF-FL-851D25-LFV2	5321527
	Welded flange/welded connector DIN11851-1, DN40 / PN40, Stainless steel 1.4404	BEF-FL-851D40-LFV2	5321459
	Welded flange/welded connector DIN11851-1, DN50 / PN25, Stainless steel 1.4404	BEF-FL-851D50-LFV2	5321528

	Brief description	Type	Part no.
	Welded flange/welded connector, process connection G 1, Stainless steel 1.4404	BEF-FL-GEWG10-LFV2	4054605
	Welded flange/welded connector, G 3/4 process connection, Stainless steel 1.4404	BEF-FL-GEWG34-LFV2	4054604
	Welded flange/welded connector, process connection Tri-Clamp 1", Stainless steel 1.4404	BEF-FL-TCLI10-LFV2	5321678
	Welded flange/welded connector, process connection Tri-Clamp 2", Stainless steel 1.4404	BEF-FL-TCLI20-LFV2	5321679

## SICK AT A GLANCE

SICK is one of the leading manufacturers of intelligent sensors and sensor solutions for industrial applications. A unique range of products and services creates the perfect basis for controlling processes securely and efficiently, protecting individuals from accidents and preventing damage to the environment.

We have extensive experience in a wide range of industries and understand their processes and requirements. With intelligent sensors, we can deliver exactly what our customers need. In application centers in Europe, Asia and North America, system solutions are tested and optimized in accordance with customer specifications. All this makes us a reliable supplier and development partner.

Comprehensive services complete our offering: SICK LifeTime Services provide support throughout the machine life cycle and ensure safety and productivity.

For us, that is “Sensor Intelligence.”

## WORLDWIDE PRESENCE:

Contacts and other locations –[www.sick.com](http://www.sick.com)