



LFBV310-XXGBVTMTX

LFBV300

LEVEL SENSORS

SICK
Sensor Intelligence.



Illustration may differ



Ordering information

Type	Part no.
LFV310-XXGBVTMTX	6037994

Other models and accessories → www.sick.com/LFV300

Detailed technical data

Features

Medium	Fluids
Measurement	Switch
Probe length	66 mm
Process pressure	-1 bar ... 64 bar
Process temperature	-50 °C ... +250 °C
Fill material density	0.5 g/cm ³ ... 2.5 g/cm ³

Performance

Accuracy of sensor element	± 2 mm
Reproducibility	≤ 1 mm
Viscosity	0.1 mPas ... 10,000 mPas
Response time	500 ms
MTBF	9,73*10 ⁶ h

Electronics

Residual ripple	≤ 5 V _{pp}
Power consumption	< 10 mA
Initialization time	< 2 s
VDE protection class 2	✓
Connection type	M20 x 1.5
Output signal	1 x PNP/NPN
Supply voltage	Volt-free transistor output PNP/ NPN: 10 V DC ... 55 V DC
Hysteresis	2 mm
Output current	< 300 mA
Inductive load	1 H
Capacitive load	100 nF
Enclosure rating	IP66 / IP67
Temperature drift	0,03 mm/K

Mechanics

Wetted parts	Stainless steel 316L (optional Ra ≤ 0.8 μm)
Process connection	G ¾ A PN 64 / 1.4404
Housing material	Aluminum
Sensor material	Stainless steel 1.4404

Ambient data

Ambient operating temperature	-40 °C ... +70 °C
Ambient temperature, storage	-40 °C ... +80 °C

Classifications

ECLASS 5.0	27273202
ECLASS 5.1.4	27273202
ECLASS 6.0	27273202
ECLASS 6.2	27273202
ECLASS 7.0	27273202
ECLASS 8.0	27273202
ECLASS 8.1	27273202
ECLASS 9.0	27273202
ECLASS 10.0	27273202
ECLASS 11.0	27273202
ECLASS 12.0	27273106
ETIM 5.0	EC002654
ETIM 6.0	EC002654
ETIM 7.0	EC002654
ETIM 8.0	EC002654
UNSPSC 16.0901	41111938

Type code

LFV310 type code

Certification

XX	Without
XA	WHG authorization
CA	ATEX II 1G, 1/2G, 2G Ex ia IIC T6 Ga, Ga/Gb, Gb +WHG
DA	ATEX II 1/2G Ex db IIC T6...T2 Ga/Gb +WHG

Process connection / Material (see below)

Spacer / Process temperature

X	Without / -50 °C ... +150 °C
T	With / -50 °C ... +250 °C

Housing / Cable gland

P	Plastic IP 66, IP 67 / M20 x 1.5
N	Plastic IP 66, IP 67 / ½" NPT
M	Aluminum IP 66, IP 67 / M20 x 1.5
U	Aluminum IP 66, IP 67 / ½" NPT
V	Stainless steel (investment casting) 316L, IP 66, IP 67 / M20 x 1.5
A	Stainless steel (investment casting) 316L, IP 66, IP 67 ½" NPT
8	Stainless steel (electropolished) 316L, IP 66, IP 67 / M20 x 1.5

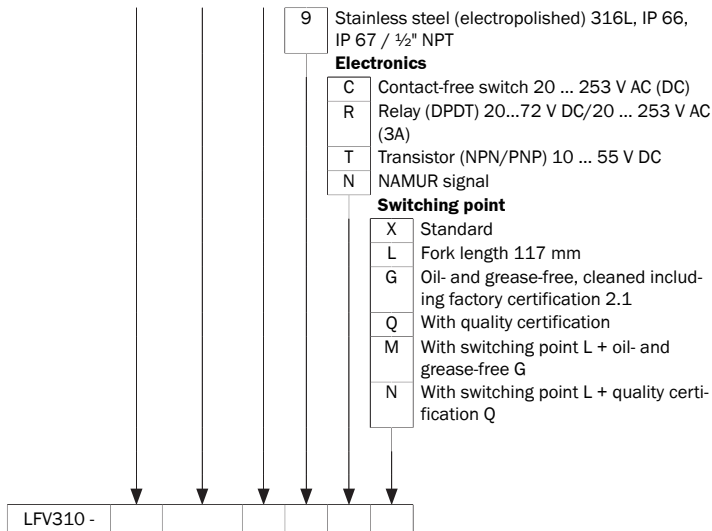

Not all variants of the type code can be combined! Not all available variants are shown.

Process connection / Material

GBV	Thread G 3/4 A, PN 64 / 316L	PLV	Flange, DN 125, PN 40 form N, DIN 2501 / 316L
GBP	Thread G 3/4 A, PN 64 / 316L, Ra < 0.8µm	FMV	Flange, DN 150, PN 16 form C, DIN 2501 / 316L
NBV	Thread 3/4" NPT, PN 64 / 316L	MMV	Flange, DN 150, PN 16 form D, DIN 2501 / 316L
NBP	Thread 3/4" NPT, PN 64 / 316L, Ra < 0.8 µm	FVV	Flange, DN 150, PN 40, form C, DIN 2501 / 316L
GAV	Thread G 1 A, PN 64 / 316L	OVV	Flange, DN 150, PN 40, form F, DIN 2501 / 316L
GAP	Thread G 1 A, PN 64 / 316L, Ra < 0.8 µm	PVV	Flange, DN 150, PN 40, form N, DIN 2501 / 316L
NAV	Thread 1" NPT, PN 64 / 316L	FQV	Flange, DN 200, PN 16, form C, DIN 2501 / 316L
NAP	Thread 1" NPT, PN 64 / 316L, Ra < 0.8µm	F5V	Flange, DN 250, PN 10, form C, DIN 2501 / 316L
GCV	Thread G 1 1/2 A, PN 64 / 316L	UCV	Flange, DN 40, PN 40, V13, DIN 2501 / 316L
NCV	Thread 1 1/2" NPT, PN 64 / 316L	FEV	Flange, DN 50, PN 40, form C, DIN 2501 / 316L
TAP	Varivent N50-40 / 316L, Ra < 0.8 µm	RCP	Pipe connection, DN 25, PN 40, DIN 11851 / 316L, Ra < 0.8 µm
TNP	Varivent N25-100 / 316L, Ra < 0.8 µm	REP	Pipe connection, DN 32, PN 40, DIN 11851 / 316L, Ra < 0.8 µm
CCP	Tri-Clamp 1", PN 16 / 316L, Ra < 0.8 µm	RAP	Pipe connection, DN 40, PN 40, DIN 11851 / 316L, Ra < 0.8 µm
CBP	Tri-Clamp 1 1/2", PN 16 / 316L, Ra < 0.8 µm	RFP	Pipe connection, DN 40, PN 40, DIN 11864-1A / 316L, Ra < 0.8 µm
CAP	Tri-Clamp 2", PN 16 / 316L, Ra < 0.8 µm	RBP	Pipe connection, DN 50, PN 25, DIN11851 / 316L, Ra < 0.8 µm
CDP	Tri-Clamp 2 1/2" PN 10 / 316L, Ra < 0.8 µm	RDP	Pipe connection, DN 50, PN 25, DIN11864-1A / 316L, Ra < 0.8 µm
CEP	Tri-Clamp 3", PN 10 / 316L, Ra < 0.8 µm	SMP	Small flange DN50PN1.5 DIN28403 / 316L pol.Ra < 0.8 µm
GBN	Thread G 3/4 A, PN 64 / 316L, Ra < 0.3 µm	SNP	Small flange DN40PN1.5 DIN28403 / 316L pol.Ra < 0.8 µm
GCP	Thread G 1 1/2 A, PN 64 / 316L, Ra < 0.8 µm	RIP	Ingold connection PN16 / 316L Ra < 0.8 µm
NCP	Thread G 1 1/2" NPT PN 64 / 316L, Ra < 0.8 µm	LGP	DB50L / 316L, Ra < 0.8 µm
GEV	Thread G 2 A PN64 / 316L	SGD	Bundle clamp DN33, 7PN40, DIN11864-3-A / 316L, BN2, Ra < 0.8 µm
GDV	Thread M27x1.5 PN64 / 316L	SHP	Aseptic lapped flange DN50PN16, DIN11864-3-A / 316 L, Ra < 0.8 µm
GFV	Thread M27x2 PN64 / 316L	SJP	Aseptic lapped flange DN100PN16, DIN11864-3-A / 316 L, Ra < 0.8 µm
KAP	Cone DN25 PN40 / 316L, Ra < 0.8 µm	FTV	Flange, DN 25, PN 6, form C, DIN 2501 / 316L
KBP	Cone M52 PN40 / 316 L, Ra < 0.8 µm	FPV	Flange, DN 25, PN 40, form C, DIN 2501 / 316L
LAP	Aseptic with union nut F40P-N25 / 316L, Ra < 0.8 µm, ZB3052	FRV	Flange, DN 25, PN 40, form D, DIN 2501 / 316L
DAV	DRD flange PN40 / 316L, ZB3007	OPV	Flange, DN 25, PN 40, form F, DIN 2501 / 316L
RRP	SMS DN38PN6 / 316L, Ra < 0.8 µm	PPV	Flange, DN 25, PN 40, form N, DIN 2501 / 316L
RTP	SMS DN51PN6 / 316L, Ra < 0.8 µm	UPV	Flange, DN 25, PN 40, V13, DIN 2501 / 316L
SBA	Neumo biocontrol size 25PN16 / 316L, Ra < 0.8 µm	FBV	Flange, DN 32, PN 40, form C, DIN 2501 / 316L

SAP	Neumo biocontrol size 50PN16 / 316L, Ra < 0.8 µm
SCP	Neumo biocontrol Gr.65PN16 / 316L, Ra < 0.8 µm
SDP	Neumo biocontrol Gr.80PN16 / 316L, Ra < 0.8 µm
RUP	SÜDMO W500 DN50PN10 / 316L, Ra < 0.8 µm
PCV	Flange, DN 40, PN 40, form N, DIN 2501 / 316L
MEV	Flange, DN 50, PN 40, form D, DIN 2501 / 316L
OEV	Flange, DN 50, PN 40, form F, DIN 2501 / 316L
PEV	Flange, DN 50, PN 40, form N, DIN 2501 / 316L
IEV	Flange, DN 50, PN 40, form E, DIN 2501 / 316L
UEV	Flange, DN 50, PN 40, V13, DIN 2501 / 316L
EEV	Flange, DN 50, PN 40, R13, DIN 2501 / 316L
ONV	Flange, DN 50, PN 64, form F, DIN 2501 / 316L
INV	Flange, DN 50, PN 64, form E, DIN 2501 / 316L
HNV	Flange, DN 50, PN 64, form L, DIN 2501 / 316L
IYV	Flange, DN 50, PN 100, form E, DIN 2501 / 316L
HYV	Flange, DN 50, PN 100, form L, DIN 2501 / 316L
FGV	Flange, DN 65, PN 40, form C, DIN 2501 / 316L
OGV	Flange, DN 65, PN 40, form F, DIN 2501 / 316L
lIV	Flange, DN 65, PN 40, form E, DIN 2501 / 316L
FIV	Flange, DN 80, PN 40, form C, DIN 2501 / 316L
OIV	Flange, DN 80, PN 40, form F, DIN 2501 / 316L
PIV	Flange, DN 80, PN 40, form N, DIN 2501 / 316L
FJC	Flange, DN 100, PN 16, form B1, EN1092-1 / 316L
FKC	Flange, DN 100, PN 40, form B1, EN1092-1 / 316L
OKC	Flange, DN 100, PN 40, form C, EN1092-1 / 316L
PKC	Flange, DN 100, PN 40, form D, EN1092-1 / 316L
PSC	Flange, DN 100, PN 63, form D, EN1092-1 / 316L
ISC	Flange, DN 100, PN 63, form B2, EN1092-1 / 316L
FMC	Flange, DN 150, PN 16, form B1, EN1092-1 / 316L
FVC	Flange, DN 150, PN 40, form B1, EN1092-1 / 316L
IVC	Flange, DN 150, PN 40, form B2, EN1092-1 / 316L
WPM	Flange 1" 150 lb RF, ANSI B16.5 / 316L
ANV	Flange 1" 300 lb RF, ANSI B16.5 / 316L
AQV	Flange 1" 600 lb RF, ANSI B16.5 / 316L
YQV	Flange 1" 600 lb LG, ANSI B16.5 / 316L
AAV	Flange 1 ½" 150 lb RF, ANSI B16.5 / 316L
ABV	Flange 1 ½" 300 lb RF, ANSI B16.5 / 316L
3BV	Flange 1 ½" 300 lb SM, ANSI B16.5 / 316L
ACV	Flange 2" 150 lb RF, ANSI B16.5 / 316L
QCV	Flange 2" 150 lb FF, ANSI B16.5 / 316L
1CV	Flange 2" 150 lb ST, ANSI B16.5 / 316L
2CV	Flange 2" 150 lb SG, ANSI B16.5 / 316L
3CV	Flange 2" 150 lb SM, ANSI B16.5 / 316L
ADV	Flange 2" 300 lb RF, ANSI B16.5 / 316L
BDV	Flange 2" 300 lb RJF, ANSI B16.5 / 316L
1DV	Flange 2" 300 lb ST, ANSI B16.5 / 316L
YDV	Flange 2" 300 lb LG, ANSI B16.5 / 316L
WDV	Flange 2" 300 lb LT, ANSI B16.5 / 316L
AOV	Flange 2" 600 lb RF, ANSI B16.5 / 316L
BOV	Flange 2" 600 lb RJF, ANSI B16.5 / 316L
YOV	Flange 2" 600 lb LG, ANSI B16.5 / 316L
BZV	Flange 2" 900 lb RJF, ANSI B16.5 / 316L
AEV	Flange 2 ½" 150 lb RF, ANSI B16.5 / 316L
AFV	Flange 2 ½" 300 lb RF, ANSI B16.5 / 316L
AGV	Flange 3" 150 lb RF, ANSI B16.5 / 316L
QGV	Flange 3" 150 lb FF, ANSI B16.5 / 316L

OBV	Flange, DN 32, PN 40, form F, DIN 2501 / 316L
FOV	Flange, DN 40, PN 6, form C, DIN 2501 / 316L
FCV	Flange, DN 40, PN 40, form C, DIN 2501 / 316L
OCV	Flange, DN 40, PN 40, form F, DIN 2501 / 316L
ICV	Flange, DN 40, PN 40, form E, DIN 2501 / 316L
U6V	Flange, DN 80, PN 64, V13, DIN 2501 / 316L
FJV	Flange, DN 100, PN 16, form C, DIN 2501 / 316L
MJV	Flange, DN 100, PN 16, form D, DIN 2501 / 316L
OJV	Flange, DN 100, PN 16, form F, DIN 2501 / 316L
PJV	Flange, DN 100, PN 16, form N, DIN 2501 / 316L
FKV	Flange, DN 100, PN 40, form C, DIN 2501 / 316L
OKV	Flange, DN 100, PN 40, form F, DIN 2501 / 316L
PKV	Flange, DN 100, PN 40, form N, DIN 2501 / 316L
UKV	Flange, DN 100, PN 40, V13, DIN 2501 / 316L
PSV	Flange, DN 100, PN 64, form N, DIN 2501 / 316L
ISV	Flange, DN 100, PN 64, form E, DIN 2501 / 316L
IUV	Flange, DN 100, PN 100, form E, DIN 2501 / 316L
HUV	Flange, DN 100, PN 100, form L, DIN 2501 / 316L
OZV	Flange, DN 125, PN 16, form F, DIN 2501 / 316L
FLV	Flange, DN 125, PN 40, form C, DIN 2501 / 316L
F4V	Flange, DN 150, PN 6, form C, DIN 2501 / 316L
FPC	Flange, DN 25, PN 40, form B1, EN1092-1 / 316L
IPC	Flange, DN 25, PN 40, form B2, EN1092-1 / 316L
EPC	Flange, DN 25, PN 40, form F, EN1092-1 / 316L
F3C	Flange, DN 25, PN 63, form B1, EN1092-1 / 316L
IWC	Flange, DN 25, PN 100, form B2, EN1092-1 / 316L
FCC	Flange, DN 40, PN 40, form B1, EN1092-1 / 316L
ICC	Flange, DN 40, PN 40, form B2, EN1092-1 / 316L
FEC	Flange, DN 50, PN 40, form B1, EN1092-1 / 316L
OEC	Flange, DN 50, PN 40, form C, EN1092-1 / 316L
PEC	Flange, DN 50, PN 40, form D, EN1092-1 / 316L
IEC	Flange, DN 50, PN 40, form B2, EN1092-1 / 316L
UEC	Flange, DN 50, PN 40, form E, EN1092-1 / 316L
EEC	Flange, DN 50, PN 40, form F, EN1092-1 / 316L
ONC	Flange, DN 50, PN 63, form C, EN1092-1 / 316L
FIC	Flange, DN 80, PN 40, form B1, EN1092-1 / 316L
IIC	Flange, DN 80, PN 40, form B2, EN1092-1 / 316L
ARV	Flange 1 ½" 600 lb RF, ANSI B16.5 / 316L
AYV	Flange 3 ½" 150 lb RF, ANSI B16.5 / 316L
AIV	Flange 4" 150 lb RF, ANSI B16.5 / 316L
WIV	Flange 4" 150 lb LT, ANSI B16.5 / 316L
AJV	Flange 4" 300 lb RF, ANSI B16.5 / 316L
BJV	Flange 4" 300 lb RJF, ANSI B16.5 / 316L
YJV	Flange 4" 300 lb LG, ANSI B16.5 / 316L
WJV	Flange 4" 300 lb LT, ANSI B16.5 / 316L
AUV	Flange 4" 600 lb RF, ANSI B16.5 / 316L
BUV	Flange 4" 600 lb RJF, ANSI B16.5 / 316L
TCR	Flange 6" 150 lb RF, ANSI B16.5 / 316L
BKV	Flange 6" 150 lb RJF, ANSI B16.5 / 316L
ALV	Flange 6" 300 lb RF, ANSI B16.5 / 316L
AMV	Flange 8" 150 lb RF, ANSI B16.5 / 316L
VPV	Flange 1" BS.10 Table E / 316L
VAV	Flange 1 ½" BS.10 Table E / 316L
VHV	Flange 3 ½" BS.10 Table E / 316L
JBV	Flange DN40, 10K, JIS / 316L
JCV	Flange DN50, 10K, JIS / 316L

AHV	Flange 3" 300 lb RF, ANSI B16.5 / 316L
ATV	Flange 3" 600 lb RF, ANSI B16.5 / 316L

JGV	Flange DN80, 10K, JIS / 316L
JIV	Flange DN100, 10K, JIS / 316L

Dimensional drawing (Dimensions in mm (inch))

LFV310



- ① Thread
- ② Tri-Clamp
- ③ DN 25 cone
- ④ Bolting D 40
- ⑤ Flange
- ⑥ Gas-tight leadthrough
- ⑦ Temperature adapter

Marking on the welded flange

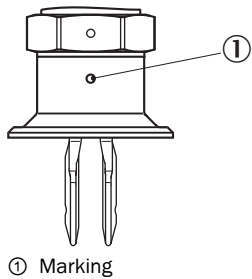

- ① Marking

Connection diagram

Transistor - electronic module

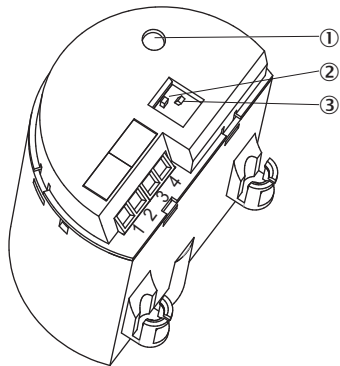

- ① Signal lamp (LED)
- ② DIL switch for mode adjustment
- ③ DIL-switch for sensitivity adjustment

PNP action

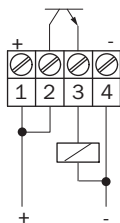

NPN action

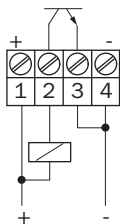

Instruction for installation

Inflowing medium



Characteristic curve





Influence of the process temperature on the switching point



- ① Shifting of the switching point in mm (in)
- ② Process temperature in °C (°F)
- ③ Switching point at reference conditions (notch)
- ④ Tuning fork

Recommended accessories

Other models and accessories → www.sick.com/LFV300

	Brief description	Type	Part no.
Electronic modules			
	Transistor (PNP/NPN): 10 V DC ... 55 V DC	ECD-RE-LFVP-NP-0001	6038672
Flanges			
	Welded flange/welded connector, DIN11851-1, DN25 / PN40, Stainless steel 1.4404	BEF-FL-851D25-LFV2	5321527
	Welded flange/welded connector, process connection G 1, Stainless steel 1.4404	BEF-FL-GEWG10-LFV2	4054605
	Welded flange/welded connector, G 3/4 process connection, Stainless steel 1.4404	BEF-FL-GEWG34-LFV2	4054604
	Welded flange/welded connector, process connection Tri-Clamp 1", Stainless steel 1.4404	BEF-FL-TCLI10-LFV2	5321678
	Welded flange/welded connector, process connection Tri-Clamp 2", Stainless steel 1.4404	BEF-FL-TCLI20-LFV2	5321679
Mounting brackets and plates			
	BEF-MU-316G10-ALFV	BEF-MU-316G10-ALFV	5322463

SICK AT A GLANCE

SICK is one of the leading manufacturers of intelligent sensors and sensor solutions for industrial applications. A unique range of products and services creates the perfect basis for controlling processes securely and efficiently, protecting individuals from accidents and preventing damage to the environment.

We have extensive experience in a wide range of industries and understand their processes and requirements. With intelligent sensors, we can deliver exactly what our customers need. In application centers in Europe, Asia and North America, system solutions are tested and optimized in accordance with customer specifications. All this makes us a reliable supplier and development partner.

Comprehensive services complete our offering: SICK LifeTime Services provide support throughout the machine life cycle and ensure safety and productivity.

For us, that is “Sensor Intelligence.”

WORLDWIDE PRESENCE:

Contacts and other locations –www.sick.com