



Lfv310-xxnavxprx

Lfv300

LEVEL SENSORS

SICK
Sensor Intelligence.



Illustration may differ



Ordering information

| Type | Part no. |
|------------------|----------|
| LFV310-XXNAVXPRX | 6044112 |

Other models and accessories → www.sick.com/LFV300

Detailed technical data

Features

| | |
|------------------------------|---|
| Medium | Fluids |
| Measurement | Switch |
| Probe length | 66 mm |
| Process pressure | -1 bar ... 64 bar |
| Process temperature | -50 °C ... +150 °C |
| Fill material density | 0.5 g/cm ³ ... 2.5 g/cm ³ |

Performance

| | |
|-----------------------------------|--------------------------|
| Accuracy of sensor element | ± 2 mm |
| Reproducibility | ≤ 1 mm |
| Viscosity | 0.1 mPas ... 10,000 mPas |
| Response time | 500 ms |
| MTBF | 9,73*10 ⁶ h |

Electronics

| | |
|-------------------------------|---|
| Power consumption | 5 mA ... 30 mA |
| Initialization time | < 2 s |
| VDE protection class 1 | ✓ |
| Connection type | M20 x 1.5 |
| Output signal | Double relay (DPDT) |
| Supply voltage | Double relay (DPDT): 20 V DC ... 72 V DC / 20 V AC ... 253 V AC |
| Hysteresis | 2 mm |
| Output current | > 10 µA; < 3A AC, 1A DC |
| Inductive load | 750 VA 54 W |
| Capacitive load | 750 VA 54 W |
| Contact load | Min. 50 mW / max. 750 VA, 54 W |
| Enclosure rating | IP66 / IP67 |
| Temperature drift | 0,03 mm/K |

Mechanics

| | |
|---------------------------|---|
| Wetted parts | Stainless steel 316L (optional Ra ≤ 0.8 μm) |
| Process connection | 1" NPT PN 64 |
| Housing material | Plastic |
| Sensor material | Stainless steel 1.4404 |

Ambient data

| | |
|--------------------------------------|-------------------|
| Ambient operating temperature | -40 °C ... +70 °C |
| Ambient temperature, storage | -40 °C ... +80 °C |

Classifications

| | |
|-----------------------|----------|
| ECLASS 5.0 | 27273202 |
| ECLASS 5.1.4 | 27273202 |
| ECLASS 6.0 | 27273202 |
| ECLASS 6.2 | 27273202 |
| ECLASS 7.0 | 27273202 |
| ECLASS 8.0 | 27273202 |
| ECLASS 8.1 | 27273202 |
| ECLASS 9.0 | 27273202 |
| ECLASS 10.0 | 27273202 |
| ECLASS 11.0 | 27273202 |
| ECLASS 12.0 | 27273106 |
| ETIM 5.0 | EC002654 |
| ETIM 6.0 | EC002654 |
| ETIM 7.0 | EC002654 |
| ETIM 8.0 | EC002654 |
| UNSPSC 16.0901 | 41111938 |

Type code

LFV310 type code

Certification

| | |
|----|--|
| XX | Without |
| XA | WHG authorization |
| CA | ATEX II 1G, 1/2G, 2G Ex ia IIC T6 Ga, Ga/Gb, Gb +WHG |
| DA | ATEX II 1/2G Ex db IIC T6...T2 Ga/Gb +WHG |

Process connection / Material (see below)

Spacer / Process temperature

| | |
|---|------------------------------|
| X | Without / -50 °C ... +150 °C |
| T | With / -50 °C ... +250 °C |

Housing / Cable gland

| | |
|---|---|
| P | Plastic IP 66, IP 67 / M20 x 1.5 |
| N | Plastic IP 66, IP 67 / ½" NPT |
| M | Aluminum IP 66, IP 67 / M20 x 1.5 |
| U | Aluminum IP 66, IP 67 / ½" NPT |
| V | Stainless steel (investment casting) 316L, IP 66, IP 67 / M20 x 1.5 |
| A | Stainless steel (investment casting) 316L, IP 66, IP 67 ½" NPT |
| 8 | Stainless steel (electropolished) 316L, IP 66, IP 67 / M20 x 1.5 |

| | |
|-----|--|
| SAP | Neumo biocontrol size 50PN16 / 316L, Ra < 0.8 µm |
| SCP | Neumo biocontrol Gr.65PN16 / 316L, Ra < 0.8 µm |
| SDP | Neumo biocontrol Gr.80PN16 / 316L, Ra < 0.8 µm |
| RUP | SÜDMO W500 DN50PN10 / 316L, Ra < 0.8 µm |
| PCV | Flange, DN 40, PN 40, form N, DIN 2501 / 316L |
| MEV | Flange, DN 50, PN 40, form D, DIN 2501 / 316L |
| OEV | Flange, DN 50, PN 40, form F, DIN 2501 / 316L |
| PEV | Flange, DN 50, PN 40, form N, DIN 2501 / 316L |
| IEV | Flange, DN 50, PN 40, form E, DIN 2501 / 316L |
| UEV | Flange, DN 50, PN 40, V13, DIN 2501 / 316L |
| EEV | Flange, DN 50, PN 40, R13, DIN 2501 / 316L |
| ONV | Flange, DN 50, PN 64, form F, DIN 2501 / 316L |
| INV | Flange, DN 50, PN 64, form E, DIN 2501 / 316L |
| HNV | Flange, DN 50, PN 64, form L, DIN 2501 / 316L |
| IYV | Flange, DN 50, PN 100, form E, DIN 2501 / 316L |
| HYV | Flange, DN 50, PN 100, form L, DIN 2501 / 316L |
| FGV | Flange, DN 65, PN 40, form C, DIN 2501 / 316L |
| OGV | Flange, DN 65, PN 40, form F, DIN 2501 / 316L |
| lLV | Flange, DN 65, PN 40, form E, DIN 2501 / 316L |
| FIV | Flange, DN 80, PN 40, form C, DIN 2501 / 316L |
| OIV | Flange, DN 80, PN 40, form F, DIN 2501 / 316L |
| PIV | Flange, DN 80, PN 40, form N, DIN 2501 / 316L |
| FJC | Flange, DN 100, PN 16, form B1, EN1092-1 / 316L |
| FKC | Flange, DN 100, PN 40, form B1, EN1092-1 / 316L |
| OKC | Flange, DN 100, PN 40, form C, EN1092-1 / 316L |
| PKC | Flange, DN 100, PN 40, form D, EN1092-1 / 316L |
| PSC | Flange, DN 100, PN 63, form D, EN1092-1 / 316L |
| ISC | Flange, DN 100, PN 63, form B2, EN1092-1 / 316L |
| FMC | Flange, DN 150, PN 16, form B1, EN1092-1 / 316L |
| FVC | Flange, DN 150, PN 40, form B1, EN1092-1 / 316L |
| IVC | Flange, DN 150, PN 40, form B2, EN1092-1 / 316L |
| WPM | Flange 1" 150 lb RF, ANSI B16.5 / 316L |
| ANV | Flange 1" 300 lb RF, ANSI B16.5 / 316L |
| AQV | Flange 1" 600 lb RF, ANSI B16.5 / 316L |
| YQV | Flange 1" 600 lb LG, ANSI B16.5 / 316L |
| AAV | Flange 1 ½" 150 lb RF, ANSI B16.5 / 316L |
| ABV | Flange 1 ½" 300 lb RF, ANSI B16.5 / 316L |
| 3BV | Flange 1 ½" 300 lb SM, ANSI B16.5 / 316L |
| ACV | Flange 2" 150 lb RF, ANSI B16.5 / 316L |
| QCV | Flange 2" 150 lb FF, ANSI B16.5 / 316L |
| 1CV | Flange 2" 150 lb ST, ANSI B16.5 / 316L |
| 2CV | Flange 2" 150 lb SG, ANSI B16.5 / 316L |
| 3CV | Flange 2" 150 lb SM, ANSI B16.5 / 316L |
| ADV | Flange 2" 300 lb RF, ANSI B16.5 / 316L |
| BDV | Flange 2" 300 lb RJF, ANSI B16.5 / 316L |
| 1DV | Flange 2" 300 lb ST, ANSI B16.5 / 316L |
| YDV | Flange 2" 300 lb LG, ANSI B16.5 / 316L |
| WDV | Flange 2" 300 lb LT, ANSI B16.5 / 316L |
| AOV | Flange 2" 600 lb RF, ANSI B16.5 / 316L |
| BOV | Flange 2" 600 lb RJF, ANSI B16.5 / 316L |
| YOV | Flange 2" 600 lb LG, ANSI B16.5 / 316L |
| BZV | Flange 2" 900 lb RJF, ANSI B16.5 / 316L |
| AEV | Flange 2 ½" 150 lb RF, ANSI B16.5 / 316L |
| AFV | Flange 2 ½" 300 lb RF, ANSI B16.5 / 316L |
| AGV | Flange 3" 150 lb RF, ANSI B16.5 / 316L |
| QGV | Flange 3" 150 lb FF, ANSI B16.5 / 316L |

| | |
|-----|---|
| OBV | Flange, DN 32, PN 40, form F, DIN 2501 / 316L |
| FOV | Flange, DN 40, PN 6, form C, DIN 2501 / 316L |
| FCV | Flange, DN 40, PN 40, form C, DIN 2501 / 316L |
| OCV | Flange, DN 40, PN 40, form F, DIN 2501 / 316L |
| ICV | Flange, DN 40, PN 40, form E, DIN 2501 / 316L |
| U6V | Flange, DN 80, PN 64, V13, DIN 2501 / 316L |
| FJV | Flange, DN 100, PN 16, form C, DIN 2501 / 316L |
| MJV | Flange, DN 100, PN 16, form D, DIN 2501 / 316L |
| OJV | Flange, DN 100, PN 16, form F, DIN 2501 / 316L |
| PJV | Flange, DN 100, PN 16, form N, DIN 2501 / 316L |
| FKV | Flange, DN 100, PN 40, form C, DIN 2501 / 316L |
| OKV | Flange, DN 100, PN 40, form F, DIN 2501 / 316L |
| PKV | Flange, DN 100, PN 40, form N, DIN 2501 / 316L |
| UKV | Flange, DN 100, PN 40, V13, DIN 2501 / 316L |
| PSV | Flange, DN 100, PN 64, form N, DIN 2501 / 316L |
| ISV | Flange, DN 100, PN 64, form E, DIN 2501 / 316L |
| IUV | Flange, DN 100, PN 100, form E, DIN 2501 / 316L |
| HUV | Flange, DN 100, PN 100, form L, DIN 2501 / 316L |
| OZV | Flange, DN 125, PN 16, form F, DIN 2501 / 316L |
| FLV | Flange, DN 125, PN 40, form C, DIN 2501 / 316L |
| F4V | Flange, DN 150, PN 6, form C, DIN 2501 / 316L |
| FPC | Flange, DN 25, PN 40, form B1, EN1092-1 / 316L |
| IPC | Flange, DN 25, PN 40, form B2, EN1092-1 / 316L |
| EPC | Flange, DN 25, PN 40, form F, EN1092-1 / 316L |
| F3C | Flange, DN 25, PN 63, form B1, EN1092-1 / 316L |
| IWC | Flange, DN 25, PN 100, form B2, EN1092-1 / 316L |
| FCC | Flange, DN 40, PN 40, form B1, EN1092-1 / 316L |
| ICC | Flange, DN 40, PN 40, form B2, EN1092-1 / 316L |
| FEC | Flange, DN 50, PN 40, form B1, EN1092-1 / 316L |
| OEC | Flange, DN 50, PN 40, form C, EN1092-1 / 316L |
| PEC | Flange, DN 50, PN 40, form D, EN1092-1 / 316L |
| IEC | Flange, DN 50, PN 40, form B2, EN1092-1 / 316L |
| UEC | Flange, DN 50, PN 40, form E, EN1092-1 / 316L |
| EEC | Flange, DN 50, PN 40, form F, EN1092-1 / 316L |
| ONC | Flange, DN 50, PN 63, form C, EN1092-1 / 316L |
| FIC | Flange, DN 80, PN 40, form B1, EN1092-1 / 316L |
| IIC | Flange, DN 80, PN 40, form B2, EN1092-1 / 316L |
| ARV | Flange 1 ½" 600 lb RF, ANSI B16.5 / 316L |
| AYV | Flange 3 ½" 150 lb RF, ANSI B16.5 / 316L |
| AIV | Flange 4" 150 lb RF, ANSI B16.5 / 316L |
| WIV | Flange 4" 150 lb LT, ANSI B16.5 / 316L |
| AJV | Flange 4" 300 lb RF, ANSI B16.5 / 316L |
| BJV | Flange 4" 300 lb RJF, ANSI B16.5 / 316L |
| YJV | Flange 4" 300 lb LG, ANSI B16.5 / 316L |
| WJV | Flange 4" 300 lb LT, ANSI B16.5 / 316L |
| AUV | Flange 4" 600 lb RF, ANSI B16.5 / 316L |
| BUV | Flange 4" 600 lb RJF, ANSI B16.5 / 316L |
| TCR | Flange 6" 150 lb RF, ANSI B16.5 / 316L |
| BKV | Flange 6" 150 lb RJF, ANSI B16.5 / 316L |
| ALV | Flange 6" 300 lb RF, ANSI B16.5 / 316L |
| AMV | Flange 8" 150 lb RF, ANSI B16.5 / 316L |
| VPV | Flange 1" BS.10 Table E / 316L |
| VAV | Flange 1 ½" BS.10 Table E / 316L |
| VHV | Flange 3 ½" BS.10 Table E / 316L |
| JBV | Flange DN40, 10K, JIS / 316L |
| JCV | Flange DN50, 10K, JIS / 316L |

| | |
|-----|--|
| AHV | Flange 3" 300 lb RF, ANSI B16.5 / 316L |
| ATV | Flange 3" 600 lb RF, ANSI B16.5 / 316L |

| | |
|-----|-------------------------------|
| JGV | Flange DN80, 10K, JIS / 316L |
| JIV | Flange DN100, 10K, JIS / 316L |

Dimensional drawing (Dimensions in mm (inch))

LFV310



- ① Thread
- ② Tri-Clamp
- ③ DN 25 cone
- ④ Bolting D 40
- ⑤ Flange
- ⑥ Gas-tight leadthrough
- ⑦ Temperature adapter

Marking on the welded flange



- ① Marking

Connection diagram

Relay - electronic module

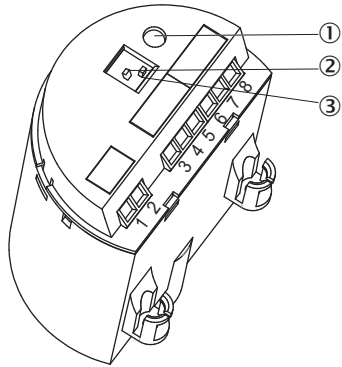

- ① Signal lamp (LED)
- ② DIL switch for mode adjustment
- ③ DIL-switch for sensitivity adjustment

Relay connection diagram (single chamber housing)

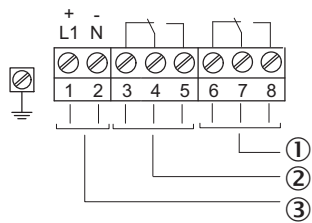

- ① Relay output
- ② Relay output
- ③ Supply voltage

Instruction for installation

Inflowing medium



Characteristic curve



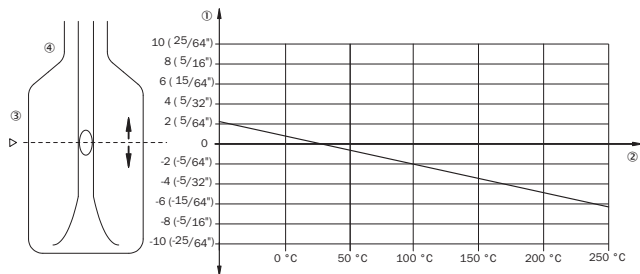

Influence of the process temperature on the switching point



- ① Shifting of the switching point in mm (in)
- ② Process temperature in °C (°F)
- ③ Switching point at reference conditions (notch)
- ④ Tuning fork

Recommended accessories

Other models and accessories → www.sick.com/LFV300

| | Brief description | Type | Part no. |
|---|---|--------------------|----------|
| Electronic modules | | | |
|  | Double relay (DPDT): 20 V DC ... 72 V DC / 20 ... 250 V AC | ECD-RE-LFVREL-0001 | 6038671 |
| Flanges | | | |
|  | Welded flange/welded connector, DIN11851-1, DN25 / PN40, Stainless steel 1.4404 | BEF-FL-851D25-LFV2 | 5321527 |
|  | Welded flange/welded connector, process connection G 1, Stainless steel 1.4404 | BEF-FL-GEWG10-LFV2 | 4054605 |
|  | Welded flange/welded connector, G 3/4 process connection, Stainless steel 1.4404 | BEF-FL-GEWG34-LFV2 | 4054604 |
|  | Welded flange/welded connector, process connection Tri-Clamp 1", Stainless steel 1.4404 | BEF-FL-TCLI10-LFV2 | 5321678 |
| | Welded flange/welded connector, process connection Tri-Clamp 2", Stainless steel 1.4404 | BEF-FL-TCLI20-LFV2 | 5321679 |
| Mounting brackets and plates | | | |
| | BEF-MU-316G10-ALFV | BEF-MU-316G10-ALFV | 5322463 |

SICK AT A GLANCE

SICK is one of the leading manufacturers of intelligent sensors and sensor solutions for industrial applications. A unique range of products and services creates the perfect basis for controlling processes securely and efficiently, protecting individuals from accidents and preventing damage to the environment.

We have extensive experience in a wide range of industries and understand their processes and requirements. With intelligent sensors, we can deliver exactly what our customers need. In application centers in Europe, Asia and North America, system solutions are tested and optimized in accordance with customer specifications. All this makes us a reliable supplier and development partner.

Comprehensive services complete our offering: SICK LifeTime Services provide support throughout the machine life cycle and ensure safety and productivity.

For us, that is “Sensor Intelligence.”

WORLDWIDE PRESENCE:

Contacts and other locations –www.sick.com