

LL3-LM36150

Fiber-optic cables

FIBERS

SICK
Sensor Intelligence.

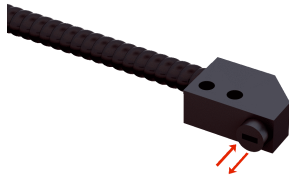

Illustration may differ

Ordering information

Type	Part no.
LL3-LM36150	2073491

Other models and accessories → www.sick.com/Fiber-optic_cables

Detailed technical data

Features

Device type	Fiber-optic cables
Functional principle	Proximity system
Fiber-optic head design	Flat type, 90° deflection
Application	Standard
Compatible fiber-optic amplifiers	WLL80, WLL180, GLL170(T)
Sensing range max.	Depending on the fiber optic amplifier used
Minimal object diameter	0.5 mm
Optical fiber head	
Angle of dispersion	60°
Integrated lens	No
Compatibility tip adapters	No
Optical fiber	
Compatibility with infrared light	Yes ¹⁾
Adapter end sleeves required	No

¹⁾ Reduced sensing ranges possible when using a fiber-optic amplifier with infrared light.

Mechanics

Optical fiber head		
Light emission	Radial	
Optical fiber		
Fiber length	150 mm	
Bending radius	20 mm	
Dynamic flexibility (robotics)	No	
Outside diameter, optical fiber cable connection	2.2 mm	
Fiber arrangement	Multi-fiber	
Core structure	Multi-fiber	
Material		
Optical fiber head	Chrome-plated metal coil	
Sheath	Polyvinylchlorid (PVC)	
Fibers	Glass	
Weight	18 g	

Ambient data

Ambient operating temperature	-10 °C ... +60 °C
--------------------------------------	-------------------

Classifications

ECLASS 5.0	27270905
ECLASS 5.1.4	27270905
ECLASS 6.0	27270905
ECLASS 6.2	27270905
ECLASS 7.0	27270905
ECLASS 8.0	27270905
ECLASS 8.1	27270905
ECLASS 9.0	27270905
ECLASS 10.0	27270905
ECLASS 11.0	27270905
ECLASS 12.0	27270905
ETIM 5.0	EC002651
ETIM 6.0	EC002651
ETIM 7.0	EC002651
ETIM 8.0	EC002651
UNSPSC 16.0901	39121528

Sensing ranges with WLL180T

Operating mode 16 µs	50 mm
Operating mode 70 µs	160 mm
Operating mode 250 µs	210 mm
Operating mode 2 ms	240 mm
Operating mode 8 ms	260 mm
Note	Sensing ranges related to fiber-optic sensors with type of light: visible red light

Sensing ranges with GLL170

Operating mode 250 µs	97 mm
------------------------------	-------

Sensing ranges with GLL170T

Operating mode 50 µs	132 mm
Operating mode 250 µs	229 mm

Dimensional drawing (Dimensions in mm (inch))

LL3-LM36150

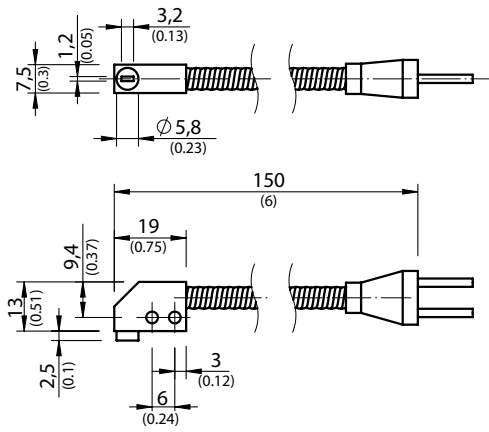

SICK AT A GLANCE

SICK is one of the leading manufacturers of intelligent sensors and sensor solutions for industrial applications. A unique range of products and services creates the perfect basis for controlling processes securely and efficiently, protecting individuals from accidents and preventing damage to the environment.

We have extensive experience in a wide range of industries and understand their processes and requirements. With intelligent sensors, we can deliver exactly what our customers need. In application centers in Europe, Asia and North America, system solutions are tested and optimized in accordance with customer specifications. All this makes us a reliable supplier and development partner.

Comprehensive services complete our offering: SICK LifeTime Services provide support throughout the machine life cycle and ensure safety and productivity.

For us, that is “Sensor Intelligence.”

WORLDWIDE PRESENCE:

Contacts and other locations –www.sick.com