



LUT3-950

LUT3

LUMINESCENCE SENSORS

SICK
Sensor Intelligence.



Illustration may differ



Ordering information

Type	Part no.
LUT3-950	1019287

Other models and accessories → www.sick.com/LUT3

Detailed technical data

Features

Dimensions (W x H x D)	30.4 mm x 53 mm x 80 mm
Sensing distance	≤ 50 mm ¹⁾
Housing design	Large
Light source	LED, UV ²⁾
Wave length	375 nm
Light spot size	5 mm x 15 mm
Receiving filters	≤ 420 nm ³⁾
Receiving range	450 nm ... 750 nm
Adjustment	Potentiometer
Output function	Light switching

¹⁾ From leading edge of lens.

²⁾ Average service life: 100,000 h at T_J = +25 °C.

³⁾ Filter blocks shorter wavelengths to suppress background luminescence.

Mechanics/electronics

Supply voltage	12 V DC ... 30 V DC ¹⁾
Ripple	< 2 V _{pp} ²⁾
Current consumption	< 60 mA ³⁾
Switching frequency	1.5 kHz ⁴⁾
Response time	350 μs ⁵⁾
Switching output	PNP, NPN

¹⁾ Limit values when operated in short-circuit protected network: max. 8 A.

²⁾ May not fall below or exceed U_y tolerances.

³⁾ Without load.

⁴⁾ With light/dark ratio 1:1.

⁵⁾ Signal transit time with resistive load.

⁶⁾ Reference voltage DC 50 V.

Switching output (voltage)	PNP: HIGH = $V_S - \leq 3 \text{ V}$ / LOW = approx. 0 V NPN: HIGH = approx. U_V / LOW $\leq 2 \text{ V}$
Switching mode	Light switching
Analog output	0.5 mA ... 10 mA
Output current I_{max}	100 mA
Connection type	Male connector M12, 5-pin
Protection class	II ⁶⁾
Circuit protection	U_V connections, reverse polarity protected Output Q short-circuit protected Interference pulse suppression
Enclosure rating	IP67
Weight	400 g
Housing material	Zinc diecast

¹⁾ Limit values when operated in short-circuit protected network: max. 8 A.

²⁾ May not fall below or exceed U_V tolerances.

³⁾ Without load.

⁴⁾ With light/dark ratio 1:1.

⁵⁾ Signal transit time with resistive load.

⁶⁾ Reference voltage DC 50 V.

Ambient data

Ambient operating temperature	-10 °C ... +55 °C
Ambient temperature, storage	-25 °C ... +75 °C
Shock load	According to IEC 60068

Classifications

ECLASS 5.0	27270908
ECLASS 5.1.4	27270908
ECLASS 6.0	27270908
ECLASS 6.2	27270908
ECLASS 7.0	27270908
ECLASS 8.0	27270908
ECLASS 8.1	27270908
ECLASS 9.0	27270908
ECLASS 10.0	27270908
ECLASS 11.0	27270908
ECLASS 12.0	27270908
ETIM 5.0	EC001822
ETIM 6.0	EC001822
ETIM 7.0	EC001822
ETIM 8.0	EC001822
UNSPSC 16.0901	39121528

Dimensional drawing (Dimensions in mm (inch))

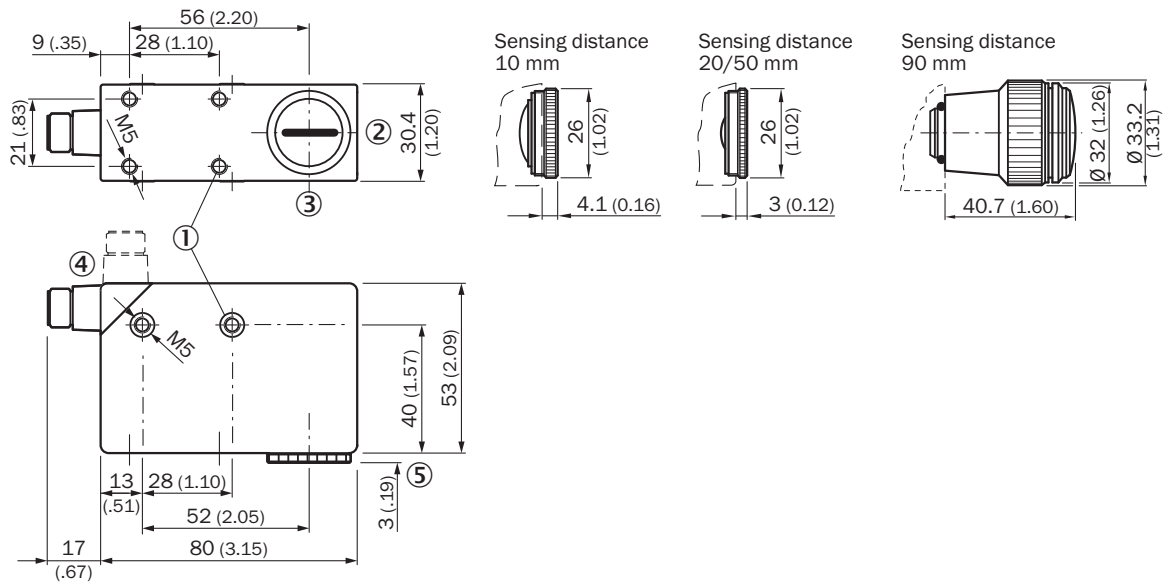

- ① M5 threaded mounting hole, 5.5 mm deep
- ② Light spot direction
- ③ Center of optical axis
- ④ Connector M12 (rotatable up to 90°)
- ⑤ See dimensional drawings of lenses

Pinouts

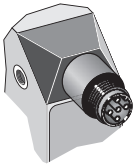

Adjustments

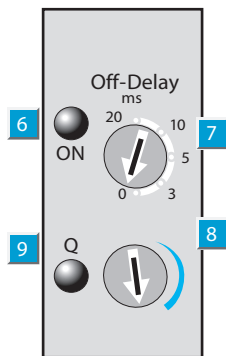

- ⑥ Operating indicator
- ⑦ Time delay selector switch
- ⑧ Sensitivity control
- ⑨ Output indicator

Connection diagram

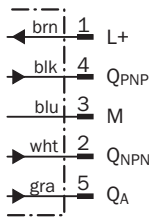



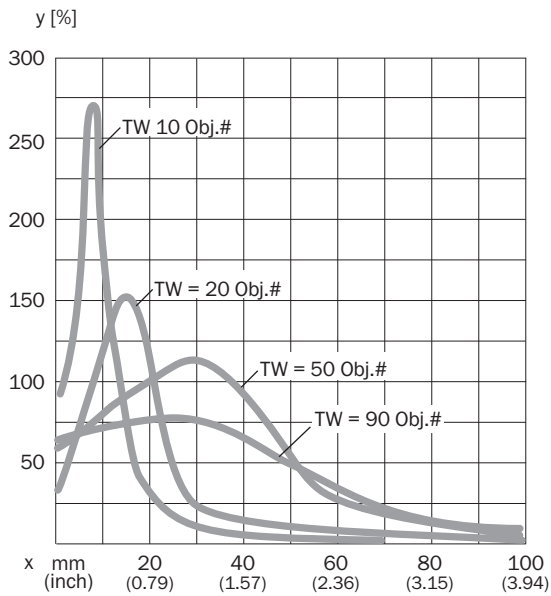



Sensing distance



Recommended accessories

Other models and accessories → www.sick.com/LUT3

	Brief description	Type	Part no.
Reference materials			
	Thick chalk, red fluorescent, 12 units	LUM-FT	1004460
	Writing chalk, red fluorescence	LUM-KLK	1002959
Universal bar clamp systems			
	Plate G for universal clamp bracket, steel, zinc coated, Universal clamp (2022726), mounting hardware	BEF-KHS-G01	2022464

	Brief description	Type	Part no.
	Plate K for universal clamp bracket, steel, zinc coated, Universal clamp (2022726), mounting hardware	BEF-KHS-K01	2022718
	Universal bar clamp for mounting bars with 12-20 mm diameter, steel, zinc coated, without mounting hardware	BEF-KHS-KH1	2022726
	Mounting bar, straight, 200 mm, steel, steel, zinc coated, without mounting hardware	BEF-MS12G-A	4056054
	Mounting bar, straight, 300 mm, steel, steel, zinc coated, without mounting hardware	BEF-MS12G-B	4056055
	Mounting bar, L-shaped, 150 mm x 150 mm, steel, steel, zinc coated, without mounting hardware	BEF-MS12L-A	4056052
	Mounting bar, L-shaped, 250 x 250 mm, steel, steel, zinc coated, without mounting hardware	BEF-MS12L-B	4056053

SICK AT A GLANCE

SICK is one of the leading manufacturers of intelligent sensors and sensor solutions for industrial applications. A unique range of products and services creates the perfect basis for controlling processes securely and efficiently, protecting individuals from accidents and preventing damage to the environment.

We have extensive experience in a wide range of industries and understand their processes and requirements. With intelligent sensors, we can deliver exactly what our customers need. In application centers in Europe, Asia and North America, system solutions are tested and optimized in accordance with customer specifications. All this makes us a reliable supplier and development partner.

Comprehensive services complete our offering: SICK LifeTime Services provide support throughout the machine life cycle and ensure safety and productivity.

For us, that is “Sensor Intelligence.”

WORLDWIDE PRESENCE:

Contacts and other locations –www.sick.com