

M40S-62A503AA0

M4000 Advanced Curtain

SAFETY LIGHT CURTAINS

SICK
Sensor Intelligence.

Illustration may differ

Ordering information

Resolution	Scanning range	Protective field height	System part	Type	Part no.
14 mm	10 m	600 mm	Sender	M40S-62A503AA0	1203266

Other models and accessories → www.sick.com/M4000_Advanced_Curtain



Detailed technical data

Features

System part	Sender
Resolution	14 mm
Scanning range	10 m
Protective field height	600 mm
Synchronization	Optical synchronisation

Safety-related parameters

Type	Type 4 (IEC 61496-1)
Safety integrity level	SIL 3 (IEC 61508)
Category	Category 4 (EN ISO 13849)
Performance level	PL e (EN ISO 13849)
PFH_D (mean probability of a dangerous failure per hour)	28×10^{-9} (EN ISO 13849)
T_M (mission time)	20 years (EN ISO 13849)
Safe state in the event of a fault	At least one OSSD is in the OFF state.

Functions

	Functions	Delivery status
Restart interlock	✓	Internal
External device monitoring (EDM)	✓	Activated
Beam coding	✓	Uncoded
Configurable status output (ADO)	✓	Contamination (OWS)
Sender test	✓	Deactivated
Configurable scanning range	✓	Low scanning range
Safe SICK device communication via EFI	✓	
Differentiation between man and material (muting)	✓ ¹⁾	

¹⁾ The muting functions can only be used in combination with the UE403 muting switching amplifier or a suitable safety controller (e.g., Flexi Classic, Flexi Soft).

Interfaces

System connection	
Connection type	Hirschmann male connector M26, 12-pin
Permitted cable length	≤ 50 m ¹⁾
Permitted cross-section	≥ 0 mm ²
Configuration method	Via software
Configuration connection	Female connector M8, 4-pin
Display elements	7-segment display, LEDs
Status display	LEDs

¹⁾ Depending on load, power supply and wire cross-section. The technical specifications must be observed.

Electrical data

Protection class	III (IEC 61140)
Supply voltage V_S	24 V DC (19.2 V ... 28.8 V)
Residual ripple	≤ 10 % ¹⁾
Power consumption	≤ 0.3 A

¹⁾ Within the limits of V_S .

Mechanical data

Housing cross-section	52 mm x 55.5 mm
Housing material	Aluminum alloy ALMGSI 0.5
Surface treatment	Powder coated
Front screen material	Polycarbonate, scratch-resistant coating

Ambient data

Enclosure rating	IP65 (EN 60529)
Ambient operating temperature	-30 °C ... +55 °C
Storage temperature	-30 °C ... +70 °C
Air humidity	15 % ... 95 %, Non-condensing
Vibration resistance	5 g, 10 Hz ... 55 Hz (IEC 60068-2-6)
Shock resistance	10 g, 16 ms (EN 60068-2-29)

Other information

Wave length	850 nm
--------------------	--------

Classifications

ECLASS 5.0	27272704
ECLASS 5.1.4	27272704
ECLASS 6.0	27272704
ECLASS 6.2	27272704
ECLASS 7.0	27272704
ECLASS 8.0	27272704
ECLASS 8.1	27272704
ECLASS 9.0	27272704
ECLASS 10.0	27272704

M40S-62A503AA0 | M4000 Advanced Curtain

SAFETY LIGHT CURTAINS

ECLASS 11.0	27272704
ECLASS 12.0	27272704
ETIM 5.0	EC002549
ETIM 6.0	EC002549
ETIM 7.0	EC002549
ETIM 8.0	EC002549
UNSPSC 16.0901	46171620

Dimensional drawing (Dimensions in mm (inch))

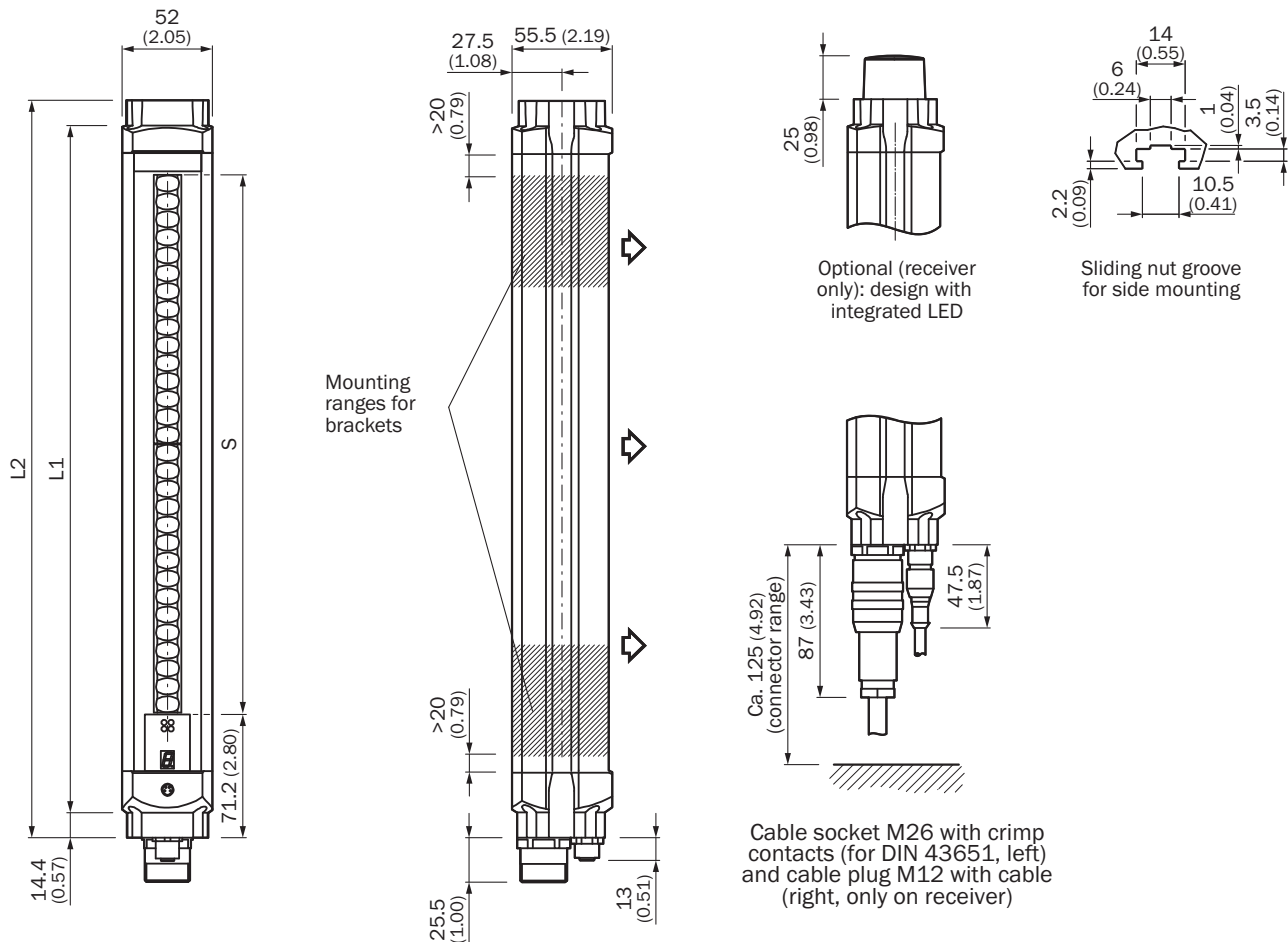









	L1	L2
300	387	416
450	537	566
600	687	716
750	837	866
900	987	1,016
1,050	1,137	1,166
1,200	1,287	1,316
1,350	1,437	1,466

	L1	L2
1,500	1,587	1,616
1,650	1,737	1,766
1,800	1,887	1,916

Recommended accessories

Other models and accessories → www.sick.com/M4000_Advanced_Curtain

	Brief description	Type	Part no.
Alignment aids			
	Laser alignment aid for various sensors, laser class 2 (IEC 60825). Do not look into the beam!, 19 mm x 67.3 mm x 66.9 mm	AR60	1015741
	Adapter AR60 for M4000 and M4000 Curtain	AR60 adapter, M4000	4040006
Mounting brackets and plates			
	4 pieces, Mounting kit 1, mounting bracket, rigid, L-shaped, including fixing screws and washers	BEF-3WNGBAST4	7021352
Terminal and alignment brackets			
	4 pieces, Mounting kit 6, side bracket, rotatable, zinc diecast	BEF-1SHABAZN4	2019506
	4 pieces, Mounting kit 12, rotatable, swivel mount	BEF-2SMGEAKU4	2030510
Others			
	<ul style="list-style-type: none"> Connection type head A: Female connector, M26, 12-pin, straight, A-coded Description: Unshielded Connection systems: Crimp contacts Permitted cross-section: 0.5 mm² ... 1.5 mm² Note: 12 crimping contacts enclosed 	DOS-0612G000GA3KM0	6020757
	<ul style="list-style-type: none"> Connection type head A: Male connector, M8, 4-pin, straight Connection type head B: Male connector, USB-A, straight Cable: 10 m, 4-wire, PVC Description: Unshielded, Configuration cable with integrated RS-232 transducer on USB for connecting a sensor configuration connection (M8, 4-pin) to the USB interface of a PC 	DSL-8U04G10M025KM1	6034575
	<ul style="list-style-type: none"> Connection type head A: Female connector, M26, 12-pin, straight Connection type head B: Flying leads Signal type: Sensor/actuator cable Cable: 20 m, 12-wire, PVC Description: Sensor/actuator cable, unshielded Connection systems: Flying leads 	DOL-0612G20M075KM0	2022549

	Brief description	Type	Part no.
	<ul style="list-style-type: none"> • Connection type head A: Male connector, M8, 4-pin, straight • Connection type head B: Male connector, USB-A, straight • Cable: 2 m, 4-wire, PVC • Description: Unshielded, Configuration cable with integrated RS-232 transducer on USB for connecting a sensor configuration connection (M8, 4-pin) to the USB interface of a PC 	DSL-8U04G02M025KM1	6034574
	<ul style="list-style-type: none"> • Connection type head A: Female connector, M26, 12-pin, straight • Connection type head B: Flying leads • Signal type: Sensor/actuator cable • Cable: 15 m, 12-wire, PVC • Description: Sensor/actuator cable, unshielded • Connection systems: Flying leads 	DOL-0612G15M075KM0	2022548
	<ul style="list-style-type: none"> • Connection type head A: Female connector, M26, 12-pin, straight • Connection type head B: Flying leads • Signal type: Sensor/actuator cable • Cable: 10 m, 12-wire, PVC • Description: Sensor/actuator cable, unshielded • Connection systems: Flying leads 	DOL-0612G10M075KM0	2022547
	<ul style="list-style-type: none"> • Connection type head A: Female connector, M26, 12-pin, straight • Connection type head B: Flying leads • Cable: 5 m, PVC • Description: Unshielded • Connection systems: Flying leads • Note: Without EFI: Pin 9 and 10 not connected 	DOL-0610G05M075KM1	2046888
	<ul style="list-style-type: none"> • Connection type head A: Female connector, M26, 12-pin, straight • Connection type head B: Flying leads • Cable: 10 m, PVC • Description: Unshielded • Connection systems: Flying leads • Note: Without EFI: Pin 9 and 10 not connected 	DOL-0610G10M075KM1	2046889
	<ul style="list-style-type: none"> • Connection type head A: Female connector, M26, 12-pin, straight • Connection type head B: Flying leads • Signal type: Sensor/actuator cable • Cable: 5 m, 12-wire, PVC • Description: Sensor/actuator cable, unshielded • Connection systems: Flying leads 	DOL-0612G05M075KM0	2022545
Switching amplifiers			
	<ul style="list-style-type: none"> • Applications: Muting switching amplifier • Compatible sensor types: M4000 Advanced multiple light beam safety devices 	UE403-A0930	1026287

SICK AT A GLANCE

SICK is one of the leading manufacturers of intelligent sensors and sensor solutions for industrial applications. A unique range of products and services creates the perfect basis for controlling processes securely and efficiently, protecting individuals from accidents and preventing damage to the environment.

We have extensive experience in a wide range of industries and understand their processes and requirements. With intelligent sensors, we can deliver exactly what our customers need. In application centers in Europe, Asia and North America, system solutions are tested and optimized in accordance with customer specifications. All this makes us a reliable supplier and development partner.

Comprehensive services complete our offering: SICK LifeTime Services provide support throughout the machine life cycle and ensure safety and productivity.

For us, that is “Sensor Intelligence.”

WORLDWIDE PRESENCE:

Contacts and other locations –www.sick.com