



M4C-SB0340LA10

deTem

SAFETY MULTIBEAM SENSORS

SICK
Sensor Intelligence.



Ordering information

Low scanning range

Number of beams	Beam separation	Scanning range	System part	Type	Part no.
3	400 mm	15.5 m	Sender	M4C-SB0340LA10	1089979

Other models and accessories → www.sick.com/deTem



Detailed technical data

Features

Application	Areas with special hygiene requirements
Functional principle	Sender/receiver
System part	Sender
Scanning range category	Low scanning range
Scanning range	15.5 m
Dimension of the light path	
Minimum	0.5 m ... 12.5 m
Typical	0.5 m ... 15.5 m
Number of beams	3
Beam separation	400 mm
Synchronization	Optical synchronisation
Items supplied	Sender in IP69K protective housing with connecting cable, 15 m

Safety-related parameters

Type	Type 4 (IEC 61496-1)
Safety integrity level	SIL3 (IEC 61508)
Category	Category 4 (ISO 13849-1)
Performance level	PL e (ISO 13849-1)
PFH_D (mean probability of a dangerous failure per hour)	3×10^{-9}
T_M (mission time)	20 years (ISO 13849-1)
Safe state in the event of a fault	At least one OSSD is in the OFF state.

Interfaces

System connection	Connecting cable, 5-wire
Length of cable	15 m
Cable diameter	5 mm
Cable material	PUR, halogen-free
Conductor cross section	0.34 mm ²
Display elements	LEDs

Electrical data

Protection class	III (IEC 61140) ¹⁾
Supply voltage V_S	24 V DC (19.2 V DC ... 28.8 V DC) ²⁾
Residual ripple	≤ 10 % ³⁾
Power consumption	≤ 50 mA
Power consumption	≤ 1.44 W (DC)

¹⁾ SELV/PELV safety/protective extra-low voltage.

²⁾ The external voltage supply must be capable of buffering brief mains voltage failures of 20 ms as specified in EN 60204-1. Suitable power supplies are available as accessories from SICK.

³⁾ Within the limits of V_S.

Mechanical data

Dimensions	See dimensional drawing
Housing diameter	50 mm
Material	
Housing	PMMA
End caps	Stainless steel 1.4404
Compensating element (membrane)	PA 6
Cable glands	Stainless steel 1.4404 including silicone seal
Weight	2,190 g (± 50 g)

Ambient data

Enclosure rating	IP65 (IEC 60529) IP66 (IEC 60529) IP67 (IEC 60529) IP69K (ISO 20653)
Ambient operating temperature	-30 °C ... +55 °C
Storage temperature	-30 °C ... +70 °C
Air humidity	15 % ... 95 %, Non-condensing
Vibration resistance	5 g, 10 Hz ... 55 Hz (IEC 60068-2-6)
Shock resistance	10 g, 16 ms (IEC 60068-2-27)

Other information

Type of light	Near-infrared (NIR), invisible
----------------------	--------------------------------

Classifications

eCl@ss 5.0	27272703
eCl@ss 5.1.4	27272703
eCl@ss 6.0	27272703
eCl@ss 6.2	27272703

eCl@ss 7.0	27272703
eCl@ss 8.0	27272703
eCl@ss 8.1	27272703
eCl@ss 9.0	27272703
eCl@ss 10.0	27272703
eCl@ss 11.0	27272703
eCl@ss 12.0	27272703
ETIM 5.0	EC001832
ETIM 6.0	EC001832
ETIM 7.0	EC001832
ETIM 8.0	EC001832
UNSPSC 16.0901	46171620

Dimensional drawing (Dimensions in mm (inch))

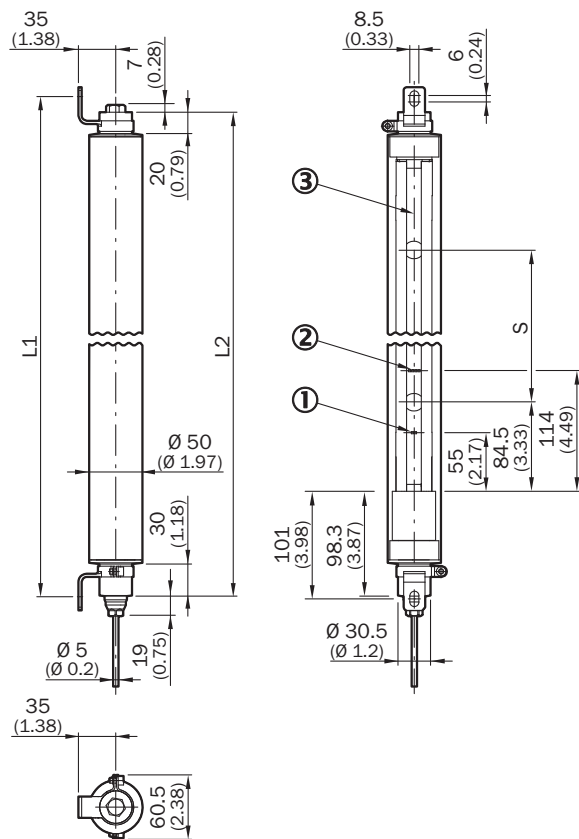

- ① Operating indicator
- ② Alignment indicator
- ③ Optical axis

		L1	L2
2	500	828	813
3	400	1,128	1,113
4	300	1,228	1,213

Connection diagram

deTem4 Core IP69K safety multibeam sensor to RLY3-OSSD2 safety relay

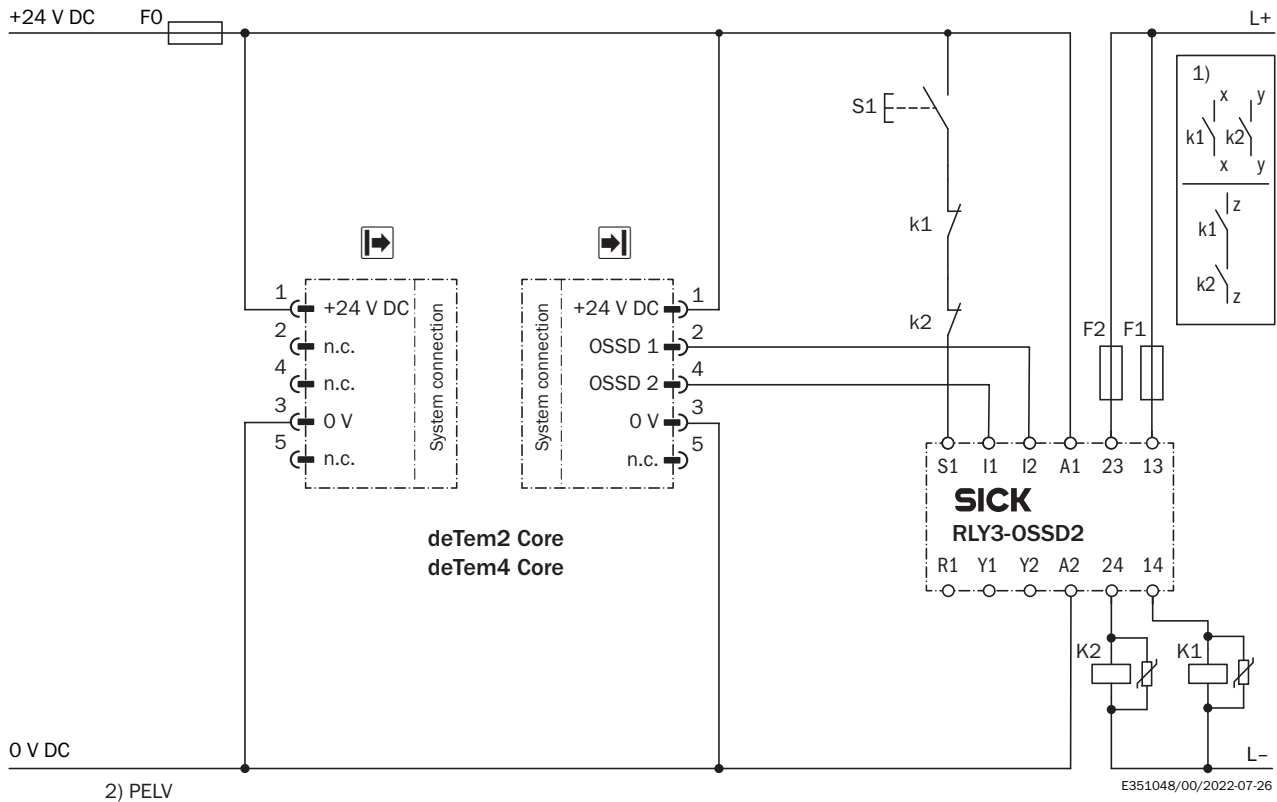

Task

Connection of a deTem4 Core IP69K or deTem2 Core IP69K safety multibeam sensor to RLY3-OSSD2.
Operating mode: with restart interlock and external device monitoring.

Function

When the protective field is clear, the OSSD1 and OSSD2 outputs carry voltage. The system can be switched on when K1 and K2 are in a fault-free de-energized position. The RLY3-OSSD2 is switched on by pressing S1 (pushbutton is pressed and released). The outputs (contacts 13-14 and 23-24) switch the K1 and K2 contactors on. When the protective field is interrupted, the OSSD1 and OSSD2 outputs switch the RLY3-OSSD2 off. Contactors K1 and K2 are switched off.

Fault analysis

Cross-circuits and short-circuits of the OSSDs are recognized and lead to the locking status (lock-out). A malfunction with one of the K1 or K2 contactors is detected. The switch-off function is retained. In the event of manipulation (e.g., jamming) of the S1 pushbutton, the RLY3-OSSD2 will not re-enable the output current circuits

Comments

¹⁾ Output circuits: These contacts must be incorporated into the control such that the dangerous state is brought to an end if the output circuit is open. For categories 4 and 3, they must be incorporated on dual-channels (x, y paths). Type 2 devices are suitable for use up to PL c. Single-channel incorporation into the control (z path) is only possible with a singlechannel control and taking the risk analysis into account.





²⁾ SELV/PELV safety extra-low voltage.

Con- nec- or-cod- tion	Col- or-cod- ed con- nect- ing cable	Sender	Receiver
1	Brown	+24 V DC	+24 V DC
2	White	Reserved	OSSD 1
3	Blue	0 V DC	0 V DC

Con- nec- tion	Col- or- cod- ed con- nect- ing cable	Sender	Receiver
4	Black	Reserved	OSSD 2
5	Gray	-	-

Recommended accessories

Other models and accessories → www.sick.com/deTem

	Brief description	Type	Part no.
Terminal and alignment brackets			
	2 pieces, Stainless steel support bracket, stainless steel 1.4350	BEF-2AAADES2	2026849
	4 pieces, Stainless steel bracket, rotatable, stainless steel 1.4350, stainless steel 1.4301	BEF-2SMMEAES4	2023708
	4 pieces, Reinforced stainless steel bracket, rotatable, stainless steel 1.4350, stainless steel 1.4301	BEF-2SMMVAES4	2026850
Safety switching amplifier			
	<ul style="list-style-type: none"> • Applications: Evaluation unit • Compatible sensor types: Safety sensors with OSSDs • Connection type: Front connector with spring terminals • Restart interlock: yes • External device monitoring (EDM): Integrated • Outputs: 2 enabling current paths (safe), 2 application diagnostic outputs (not safe), 1 test pulse output (not safe) • Housing width: 18 mm 	RLY3-OSSD200	1085344
	<ul style="list-style-type: none"> • Applications: Evaluation unit • Compatible sensor types: Safety sensors with OSSDs • Connection type: Front connector with spring terminals • Restart interlock: yes • External device monitoring (EDM): Integrated • Outputs: 3 enabling current paths (safe), 2 application diagnostic outputs (not safe), 1 test pulse output (not safe) • Housing width: 18 mm 	RLY3-OSSD300	1099969

SICK AT A GLANCE

SICK is one of the leading manufacturers of intelligent sensors and sensor solutions for industrial applications. A unique range of products and services creates the perfect basis for controlling processes securely and efficiently, protecting individuals from accidents and preventing damage to the environment.

We have extensive experience in a wide range of industries and understand their processes and requirements. With intelligent sensors, we can deliver exactly what our customers need. In application centers in Europe, Asia and North America, system solutions are tested and optimized in accordance with customer specifications. All this makes us a reliable supplier and development partner.

Comprehensive services complete our offering: SICK LifeTime Services provide support throughout the machine life cycle and ensure safety and productivity.

For us, that is “Sensor Intelligence.”

WORLDWIDE PRESENCE:

Contacts and other locations –www.sick.com