



# MASQ47-36PEKU1SA10

MAS

MAGNETIC SENSORS

**SICK**  
Sensor Intelligence.



Illustration may differ

### Ordering information

Type	Part no.
MASQ47-36PEKU1SA10	1113979

Other models and accessories → [www.sick.com/MAS](http://www.sick.com/MAS)



### Detailed technical data

#### Features

<b>Dimensions</b>	47 mm x 47 mm x 10 mm
<b>Measuring range</b>	0° ... 360°
<b>Resolution</b>	12 bit
<b>Linearity error, typ.</b>	± 1°
<b>Repeatability</b>	< 0.3° <sup>1)</sup>
<b>Number of adjustable angles</b>	32
<b>Sampling rate</b>	900 Hz
<b>Switching output</b>	3 x PNP or IO-Link mode 2 x PNP
<b>Output function</b>	Programmable (factory setting: normally open contact)
<b>Electrical wiring</b>	DC 5-wire
<b>Working distance</b>	1.5 mm ... 4 mm <sup>2)</sup>
<b>Magnetic misalignment</b>	± 0.2 mm
<b>Indication</b>	
	LED green
	Static on: power on Flashing: IO-Link mode Flashing: find device activated
	LED yellow
	Q1 (pin4) permanently on: contact closed Flashing: find device activated Flashing: Magnet too far away
	LED yellow 1
	Q2 (pin2) permanently on: contact closed Flashing: find device activated Flashing: Magnet too far away
	LED yellow 2
	Q3 (pin5) permanently on: contact closed Flashing: find device activated Flashing: Magnet too far away

<sup>1)</sup> Supply voltage  $U_B$  and constant ambient temperature  $T_a$ .

<sup>2)</sup> This specification is measured with the magnets listed under accessories. The value may vary if other magnets are used.

## Mechanics/electronics

<b>Supply voltage</b>	10 V DC ... 30 V DC
<b>Residual ripple</b>	10 %
<b>Voltage drop</b>	$\leq 2 \text{ V}^{1)}$
<b>Current consumption</b>	$\leq 30 \text{ mA}^{2)}$
<b>Continuous current <math>I_a</math></b>	$\leq 200 \text{ mA}^{3)}$
<b>Short-circuit protection</b>	Yes
<b>Reverse polarity protection</b>	Yes
<b>Power-up pulse protection</b>	✓
<b>Connection type</b>	Cable with male connector
<b>Material, cable</b>	PUR
<b>Conductor cross section</b>	0.34 mm <sup>2</sup>
<b>Cable diameter</b>	4.8 mm
<b>Housing material</b>	Plastic (PPS)
<b>Tightening torque</b>	Typ. 1 Nm
<b>Protection class</b>	III
<b>MTTFd: mean time to dangerous failure</b>	722 years
<b>UL File No.</b>	E181493
<b>DC<sub>avg</sub></b>	0 %

<sup>1)</sup> At  $I_a$  max.

<sup>2)</sup> Without load.

<sup>3)</sup> Per output.

## Communication interface

<b>Communication interface</b>	IO-Link V1.1
<b>Communication Interface detail</b>	COM3 (230,4 kBaud)
<b>Cycle time</b>	$\geq 1 \text{ ms}$
<b>Process data length</b>	4 Byte
<b>Process data structure</b>	See "Addendum to operating instructions document number 8024987"
<b>Factory setting</b>	Angle ranges: 0...120 Qint1 = Q1, 120...240 Qint2 = Q2, 240...359.9 Qint3 = Q3 Output: normally open contact Time delay: deactivated

## Ambient data

<b>EMC</b>	EN 61000-4-2 ESD: 4 kV CD / 8 kV AD, EN 61000-4-3 HF radiated: 10 V <sub>eff</sub> , EN 61000-4-4 burst: 2 kV, EN 61000-4-6 HF wire-bound: 10 V <sub>eff</sub>
<b>Enclosure rating</b>	IP67 (EN 60529) <sup>1)</sup> IP68 (EN 60529) <sup>1)</sup>
<b>Operating temperature range</b>	-40 °C ... +80 °C
<b>Resistance to shocks</b>	100 g, 6 shocks, 6 ms (EN 60068-2-27)
Continuous shock	40 g, 6 ms, 8,000 shocks (EN 60068-2-29)
<b>Resistance to vibration</b>	15 g, 5 Hz ... 2,000 Hz, 120 minutes (EN 60068-2-6)

<sup>1)</sup> IPx8 = 168h, 1m.

### Smart Task

<b>Smart Task name</b>	Base logics
<b>Timer function</b>	Deactivated Switch-on delay Off delay ON and OFF delay Impulse (one shot)
<b>Inverter</b>	Yes
<b>Switching signal</b>	
Switching signal Q <sub>L1</sub>	Switching output
Switching signal Q <sub>L2</sub>	Switching output
Switching signal Q <sub>L3</sub>	Switching output

### Classifications

<b>ECLASS 5.0</b>	27270502
<b>ECLASS 5.1.4</b>	27270502
<b>ECLASS 6.0</b>	27270590
<b>ECLASS 6.2</b>	27270590
<b>ECLASS 7.0</b>	27270502
<b>ECLASS 8.0</b>	27270502
<b>ECLASS 8.1</b>	27270502
<b>ECLASS 9.0</b>	27270502
<b>ECLASS 10.0</b>	27270502
<b>ECLASS 11.0</b>	27270502
<b>ECLASS 12.0</b>	27270502
<b>ETIM 5.0</b>	EC001486
<b>ETIM 6.0</b>	EC001486
<b>ETIM 7.0</b>	EC001486
<b>ETIM 8.0</b>	EC001486
<b>UNSPSC 16.0901</b>	41112113

### Connection diagram

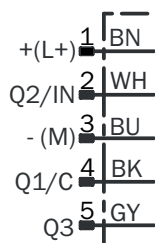
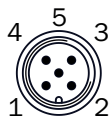



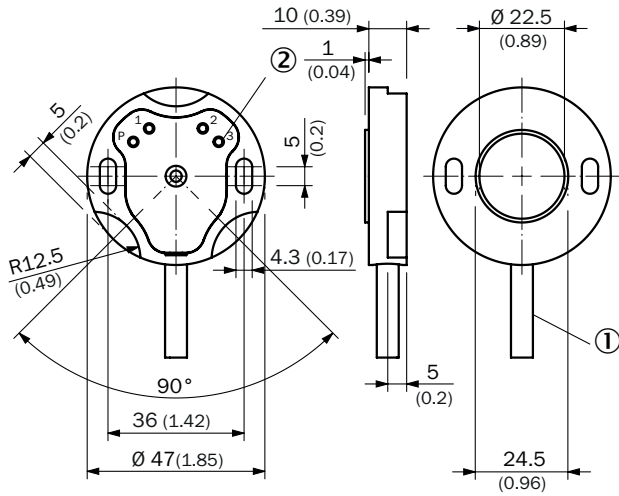

Dimensional drawing (Dimensions in mm (inch))



- ① Connection
- ② LED, (4 x)

Recommended accessories

Other models and accessories → [www.sick.com/MAS](http://www.sick.com/MAS)

	Brief description	Type	Part no.
<b>Connection modules</b>			
	IO-Link V1.1 Class A port, USB2.0 port, optional external power supply 24V / 1A	IOLA2US-01101 (SiLink2 Master)	1061790
<b>Magnets</b>			
	Neodym <sup>SM</sup> - Note: Direct or indirect sale of the Neodym magnets we supply or end products manufactured from these magnets is prohibited in the following countries: USA, Canada and Japan.	MAG-1005-N	5344197
	Magnet with bracket, Neodym <sup>SM</sup> - Note: Direct or indirect sale of the Neodym magnets we supply or end products manufactured from these magnets is prohibited in the following countries: USA, Canada and Japan.	MAGH-1004-N	2126478
	Magnet with bracket, samarium cobalt	MAGH-1004-SMCO	2131041
<b>Sensor Integration Gateway</b>			
	<ul style="list-style-type: none"> <li>• <b>Further functions:</b> Web server integrated, IIoT interface available (dual talk)</li> <li>• <b>Logic editor:</b> no</li> <li>• <b>Communication interface:</b> IO-Link, Ethernet, PROFINET, REST API, MQTT, OPC UA</li> <li>• <b>Product category:</b> IO-Link Master</li> </ul>	SIG350-0004AP100	6076871
	<ul style="list-style-type: none"> <li>• <b>Further functions:</b> Web server integrated, IIoT interface available (dual talk)</li> <li>• <b>Logic editor:</b> no</li> <li>• <b>Communication interface:</b> IO-Link, Ethernet, EtherNet/IP™, REST API, MQTT, OPC UA</li> <li>• <b>Product category:</b> IO-Link Master</li> </ul>	SIG350-0005AP100	6076923
	<ul style="list-style-type: none"> <li>• <b>Further functions:</b> Web server integrated, IIoT interface available (dual talk)</li> <li>• <b>Logic editor:</b> no</li> <li>• <b>Communication interface:</b> IO-Link, Ethernet, EtherCAT®, REST API, MQTT, OPC UA</li> <li>• <b>Product category:</b> IO-Link Master</li> </ul>	SIG350-0006AP100	6076924

## SICK AT A GLANCE

SICK is one of the leading manufacturers of intelligent sensors and sensor solutions for industrial applications. A unique range of products and services creates the perfect basis for controlling processes securely and efficiently, protecting individuals from accidents and preventing damage to the environment.

We have extensive experience in a wide range of industries and understand their processes and requirements. With intelligent sensors, we can deliver exactly what our customers need. In application centers in Europe, Asia and North America, system solutions are tested and optimized in accordance with customer specifications. All this makes us a reliable supplier and development partner.

Comprehensive services complete our offering: SICK LifeTime Services provide support throughout the machine life cycle and ensure safety and productivity.

For us, that is “Sensor Intelligence.”

## WORLDWIDE PRESENCE:

Contacts and other locations –[www.sick.com](http://www.sick.com)