



MAX48A-32C7FFE2255

MAX

MAGNETOSTRICTIVE LINEAR ENCODERS

SICK
Sensor Intelligence.



Illustration may differ

Ordering information

Type	Part no.
MAX48A-32C7FFE2255	1135469

Accessories not included with delivery, please order separately.

Other models and accessories → www.sick.com/MAX



Detailed technical data

Features

Items supplied	Accessories not included with delivery, please order separately.
-----------------------	--

Safety-related parameters

MTTF_D (mean time to dangerous failure)	69 years (EN ISO 13849-1) ¹⁾
--	---

¹⁾ This product is a standard product and does not constitute a safety component as defined in the Machinery Directive. Calculation based on nominal load of components, average ambient temperature of the electronics 60 °C, frequency of use 8,760 h/a. Every 2nd failure of an electronic component is considered hazardous.

Performance

Type	48 mm installation housing – IN cylinder mounting
Pressure pipe/End cap	10 mm / Flat
Connection type	Male connector, M12 type L (24x24 mm), 5-pin
Direction of connection	Axial
Measuring range	
Measured values	Positioning, speed
Position (F.S.)	0 mm ... 2,255 mm ¹⁾
Speed	0 ... 1,000 mm/s
Null zone	30 mm
Damping zone	63 mm
Operating conditions	
Fluid temperature	-30 °C ... +95 °C ²⁾
Air humidity	90 % (Condensation not permitted)
Operating pressure P _N	400 bar
Supply voltage	24 V DC (8 ... 32 V DC)
Switch-on time	< 250 ms
Switch-on current	Typ. 5.0 A / 50 μs
Measuring frequency (internal)	1 ms

¹⁾ F.S. = Full Scale (Measuring range).

²⁾ Depends on the maximum fluid temperature, the permissible temperature of the O-ring and the temperature-dependent signal quality of the position magnet.

³⁾ Hydraulic oil at operating temperature.

⁴⁾ This product is a standard product and does not constitute a safety component as defined in the Machinery Directive. Calculation based on nominal load of components, average ambient temperature of the electronics 60 °C, frequency of use 8,760 h/a. Every 2nd failure of an electronic component is considered hazardous.

Transmission rate (cycle time)		CANopen (0 ... 65,535 ms), factory setting: 0 ms (transmission stopped)
Accuracy	Resolution	Typ. 0.1 mm (noise-free)
	Hysteresis	± 0,1 mm
	Repeatability	Typ. ± 0.2 mm
	Linearity	Typ. ± 0.25 mm (measuring range 50 to 500 mm) ³⁾ Typ. ± 0.04% F.S. (measuring range from 500 to 2,500 mm)
Temperature drift	Warming up phase	Typ. ≤ ± 0.25 mm (2 min)
	In the operational status	Typ. ± 0.25 mm (measuring range 50 to 500 mm) ³⁾ Typ. ± 0.04% F.S. (measuring range from 500 to 2,500 mm)
MTTFd		69 years (EN ISO 13849-1) ⁴⁾

¹⁾ F.S. = Full Scale (Measuring range).

²⁾ Depends on the maximum fluid temperature, the permissible temperature of the O-ring and the temperature-dependent signal quality of the position magnet.

³⁾ Hydraulic oil at operating temperature.

⁴⁾ This product is a standard product and does not constitute a safety component as defined in the Machinery Directive. Calculation based on nominal load of components, average ambient temperature of the electronics 60 °C, frequency of use 8,760 h/a. Every 2nd failure of an electronic component is considered hazardous.

Interfaces

Communication interface		CANopen
Bus protocol		CANopen CiA DS-301
Device profile		CANopen CiA DS-406
Address setting	Baud rate	250 kbit/s
	Node ID	7F

Electrical data

Connection type		Male connector, M12 type L (24x24 mm), 5-pin
PIN assignment		1=n.c.; 2=V DC; 3=GND; 4=CAN_H; 5=CAN_L
Electrical operation	Supply voltage	24 V DC (8 ... 32 V DC)
	Residual ripple	< 1% S-S
	Power consumption	≤ 0.75 W
	Current consumption	≤ 30 mA
	Bus termination (external)	120 Ω
Overvoltage protection during power-up (60 s)		≤ 36 V at all poles during power-up (60 s) ≤ 48 V To GND during power-up (60 s)
Reverse polarity protection		≤ 36 V (at all poles) (ISO 16750-2)
Insulation resistance		R _{iso} ≥ 10 MΩ, 60 s (ISO 16750-2)
Dielectric strength		500 V DC, 0 V DC (60 s) to housing (R _{iso} ≥ 1 MΩ) (ISO 16750-2)
Short-circuit protection		V _S – GND on housing

Mechanical data

Dimensions		
	Housing	48 mm, 48f7 for IN cylinder mounting – cylinder bore hole 48H8
	∅ pressure pipe	10 mm

	Ø O-ring	40.87 mm x 3.53 mm
	Ø support ring	42.6 mm x 48 mm x 1.4 mm
	M12 flange	M12 flange type L: DM 24x24 mm - hole pattern 17 mm (EN 61076-2-101)
	Wire length	100 mm
Material		
	Housing	Stainless steel 1.4305 (AISI 303)
	Pressure pipe	Stainless steel 1.4404, AISI 316L
	O-ring	NBR 70
	Support ring	PTFE
	M12 male connector	Glass fiber reinforced polyamide, nickel-/gold-plated brass contacts
	M12 flange	Nickel-plated brass with O-ring (NBR)
	Strands	PVC

Ambient data

EMC		EU Directive 2014/30 / EU CE marking
	Generic standards	EN 61000-6-2/61000-6-3
	Agricultural and forestry machinery	EN ISO 14982
	Transient pulses	ISO 7637-2/ISO 16750-2
	ESD (air and contact discharge)	ISO 61000-4-2 / ISO 10605
Vibration		
	Sine	20 g (sine) / 55 ... 2,000 Hz / 3x24 h (IEC 60068-2-6 Fc)
	Sine over noise	18 g (r.m.s) / 10 ... 2,000 Hz / 3x36 h (IEC 60068-2-80 Fi)
	Broadband noise (resonance peaks removed)	20 g (r.m.s) / 10 ... 2,000 Hz / 3x48 h (IEC 60068-2-64 Fh)
Pressure load		
	Operating pressure P_N	400 bar
	Overload pressure $P_{max} = P_N \times 1.2$	480 bar
	Test pressure $P_{stat} = P_N \times 1.5$	600 bar
Temperature and air humidity		
	Storage	-20 °C ... +65 °C ¹⁾
	Operation (electronics)	-40 °C ... +105 °C ²⁾
	Maximum air humidity	90 % (Condensation not permitted)
Enclosure rating		
	Housing	IP67 (EN 60529)
	M12 male connector	IP69K (ISO 20653) ³⁾

¹⁾ R. H. 55%.

²⁾ Taking into account self-heating, generated through constant electrical operation with supply voltage.

³⁾ With suitable coupling (sealing through O-ring in M12 coupling nut).

Classifications

ECLASS 5.0	27270705
ECLASS 5.1.4	27270705
ECLASS 6.0	27270705
ECLASS 6.2	27270705
ECLASS 7.0	27270705

ECLASS 8.0	27270705
ECLASS 8.1	27270705
ECLASS 9.0	27270705
ECLASS 10.0	27270705
ECLASS 11.0	27270705
ECLASS 12.0	27274304
ETIM 5.0	EC002544
ETIM 6.0	EC002544
ETIM 7.0	EC002544
ETIM 8.0	EC002544
UNSPSC 16.0901	41111613

Dimensional drawing (Dimensions in mm (inch))

MAX48A

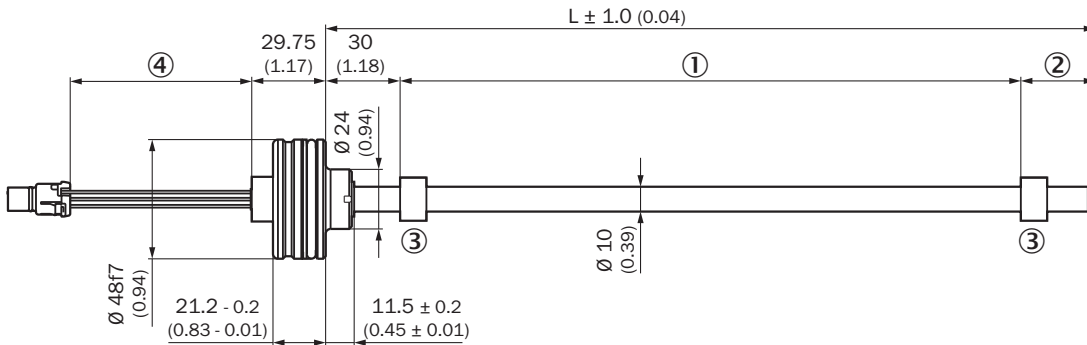

- ① Measuring range
- ② Damping zone
- ③ Position magnet
- ④ Wire length

M12 connector type L/ flange - radial seal

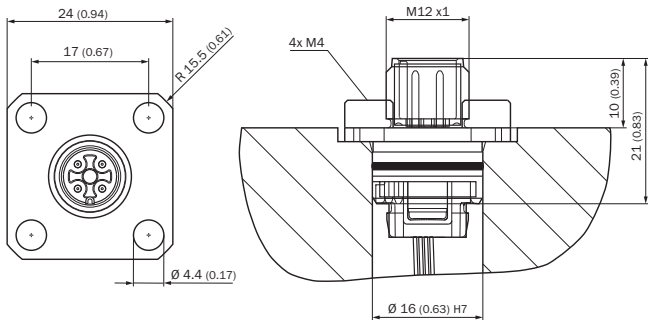

Installation of position magnet



- ① Corrugated spring washer
- ② Position magnet
- ③ Circlip
- ④ Piston

Position magnet

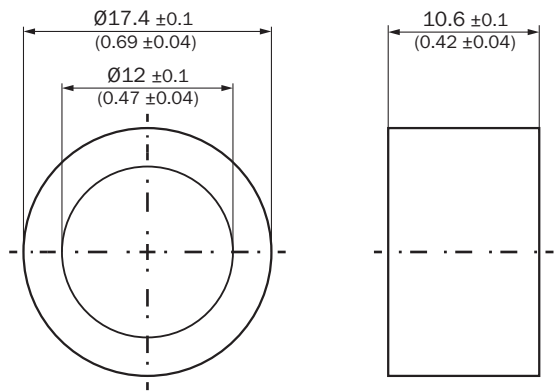

Circlip



Corrugated spring washer



① Free height

Encoder with electrical connection

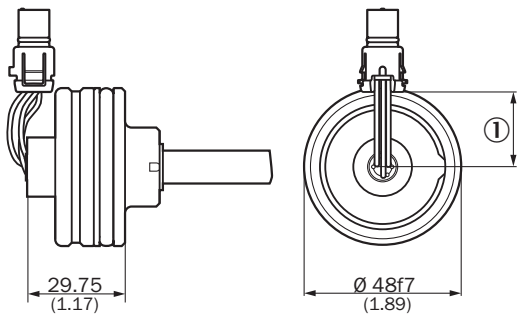

M12 male connector (analog / PWM / digital interface)

① Wire length

MAX48A housing



① Wire length

Attachment specifications

Installation space for cylinders

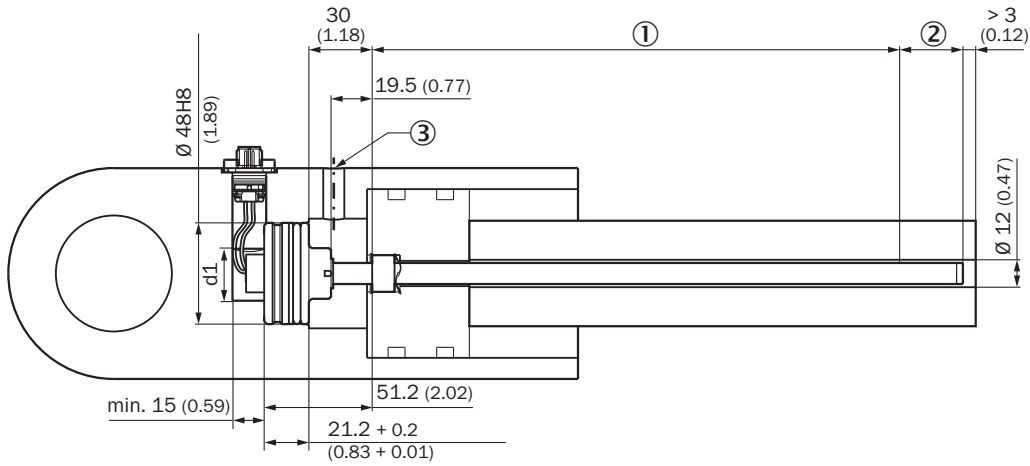

Please note the information in the operating instructions ($d: 32 \leq d1 \leq 40$).

- ① Measuring range
- ② Damping zone
- ③ Hydraulic port

PIN assignment

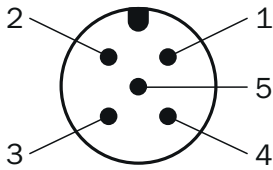

Pin assignment F (type L)

- ① N.C.
- ② V DC
- ③ GND
- ④ CAN_H
- ⑤ CAN_L

Connection diagram



Connection diagram

- ① Chassis GND
- ② Cable shielding (optional)

Recommended accessories

Other models and accessories → www.sick.com/MAX

	Brief description	Type	Part no.
Magnets			
	Position magnet for magnetostriuctive linear encoders. Installation: in hydraulic cylinder using corrugated spring washer SICK part no. 2116431. Temperature range: -30 °C ... +95 °C. Dimensions: 17.4x12x10.6 mm. Media: lubricants, hydraulic oils, no aggressive fluids (e.g., acids or bases)	MAG-O-174-01	2112714
		MAG-O-174-05	2112713
		MAG-O-174-10	2115045
		MAG-O-174-50	2112711
Flanges			
	1 piece, Flange for M12 male connector, type L square flange (24 mm x 24 mm) with radial seal, 1 piece, nickel-plated brass	BEF-FA-M12L-01	2117510
	5 pieces, Flange for M12 male connector, type L square flange (24 mm x 24 mm) with radial seal, 5 pieces, nickel-plated brass	BEF-FA-M12L-05	2117511
	10 pieces, Flange for M12 male connector, type L square flange (24 mm x 24 mm) with radial seal, 10 pieces, nickel-plated brass	BEF-FA-M12L-10	2117512
Other mounting accessories			
	1 piece, Retaining ring for installing the position magnets in the piston of the hydraulic cylinder, Stainless steel 1.4319	BEF-MK-SR-01	2116437
	5 pieces, Retaining ring for installing the position magnets in the piston of the hydraulic cylinder, Stainless steel 1.4319	BEF-MK-SR-05	2116438
	10 pieces, Retaining ring for installing the position magnets in the piston of the hydraulic cylinder, Stainless steel 1.4319	BEF-MK-SR-10	2116439
	50 pieces, Retaining ring for installing the position magnets in the piston of the hydraulic cylinder, Stainless steel 1.4319	BEF-MK-SR-50	2116440

	Brief description	Type	Part no.
	1 piece, Corrugated spring washer for installing the position magnets in the piston of the hydraulic cylinder, 1.4568 (17-7 PH Condition CH900)	BEF-MK-WF-01	2116431
	5 pieces, Corrugated spring washer for installing the position magnets in the piston of the hydraulic cylinder, 1.4568 (17-7 PH Condition CH900)	BEF-MK-WF-05	2116432
	10 pieces, Corrugated spring washer for installing the position magnets in the piston of the hydraulic cylinder, 1.4568 (17-7 PH Condition CH900)	BEF-MK-WF-10	2116433
	50 pieces, Corrugated spring washer for installing the position magnets in the piston of the hydraulic cylinder, 1.4568 (17-7 PH Condition CH900)	BEF-MK-WF-50	2116435

SICK AT A GLANCE

SICK is one of the leading manufacturers of intelligent sensors and sensor solutions for industrial applications. A unique range of products and services creates the perfect basis for controlling processes securely and efficiently, protecting individuals from accidents and preventing damage to the environment.

We have extensive experience in a wide range of industries and understand their processes and requirements. With intelligent sensors, we can deliver exactly what our customers need. In application centers in Europe, Asia and North America, system solutions are tested and optimized in accordance with customer specifications. All this makes us a reliable supplier and development partner.

Comprehensive services complete our offering: SICK LifeTime Services provide support throughout the machine life cycle and ensure safety and productivity.

For us, that is “Sensor Intelligence.”

WORLDWIDE PRESENCE:

Contacts and other locations –www.sick.com