



# MAX48N-12V30AC0080

MAX

MAGNETOSTRICTIVE LINEAR ENCODERS

**SICK**  
Sensor Intelligence.



Illustration may differ

### Ordering information

Type	Part no.
MAX48N-12V30AC0080	1130727

Accessories not included with delivery, please order separately.

Other models and accessories → [www.sick.com/MAX](http://www.sick.com/MAX)



### Detailed technical data

#### Features

<b>Items supplied</b>	Accessories not included with delivery, please order separately.
-----------------------	--

#### Safety-related parameters

<b>MTTF<sub>D</sub> (mean time to dangerous failure)</b>	69 years (EN ISO 13849-1) <sup>1)</sup>
--	---

<sup>1)</sup> This product is a standard product and does not constitute a safety component as defined in the Machinery Directive. Calculation based on nominal load of components, average ambient temperature of the electronics 60 °C, frequency of use 8,760 h/a. Every 2nd failure of an electronic component is considered hazardous.

#### Performance

<b>Type</b>	48 mm installation housing – IN cylinder mounting
<b>Pressure pipe/End cap</b>	10 mm / Flat
<b>Connection type</b>	Male connector, M12 type S (20x20 mm), 4-pin
<b>Direction of connection</b>	Radial
<b>Measuring range</b>	
Measured values	Positioning
Position (F.S.)	0 mm ... 80 mm <sup>1)</sup>
Null zone	30 mm
Damping zone	30 mm
<b>Operating conditions</b>	
Fluid temperature	-30 °C ... +95 °C <sup>2)</sup>
Air humidity	90 % (Condensation not permitted)
Operating pressure P <sub>N</sub>	400 bar
Supply voltage	24 V DC (8 ... 32 V DC)
Switch-on time	< 250 ms
Switch-on current	Typ. 5.0 A / 50 μs
Measuring frequency (internal)	2 ms
Transmission rate (cycle time)	Steady

<sup>1)</sup> F.S. = Full Scale (Measuring range).

<sup>2)</sup> Depends on the maximum fluid temperature, the permissible temperature of the O-ring and the temperature-dependent signal quality of the position magnet.

<sup>3)</sup> Hydraulic oil at operating temperature.

<sup>4)</sup> This product is a standard product and does not constitute a safety component as defined in the Machinery Directive. Calculation based on nominal load of components, average ambient temperature of the electronics 60 °C, frequency of use 8,760 h/a. Every 2nd failure of an electronic component is considered hazardous.

<b>Accuracy</b>	Setpoint tolerance	≤ ± 1 mm
	Resolution	Typ. 0.1 mm (noise-free)
	Hysteresis	± 0,1 mm
	Repeatability	Typ. ± 0.2 mm
	Linearity	Typ. ± 0.25 mm (measuring range 50 to 500 mm) <sup>3)</sup> Typ. ± 0.04% F.S. (measuring range from 500 to 2,500 mm)
<b>Temperature drift</b>	Warming up phase	Typ. ≤ ± 0.25 mm (2 min)
	In the operational status	Typ. ± 0.25 mm (measuring range 50 to 500 mm) <sup>3)</sup> Typ. ± 0.04% F.S. (measuring range from 500 to 2,500 mm)
<b>MTTFd</b>		69 years (EN ISO 13849-1) <sup>4)</sup>

<sup>1)</sup> F.S. = Full Scale (Measuring range).

<sup>2)</sup> Depends on the maximum fluid temperature, the permissible temperature of the O-ring and the temperature-dependent signal quality of the position magnet.

<sup>3)</sup> Hydraulic oil at operating temperature.

<sup>4)</sup> This product is a standard product and does not constitute a safety component as defined in the Machinery Directive. Calculation based on nominal load of components, average ambient temperature of the electronics 60 °C, frequency of use 8,760 h/a. Every 2nd failure of an electronic component is considered hazardous.

## Interfaces

<b>Communication interface</b>	Analog
<b>Communication Interface detail</b>	Voltage
<b>Voltage output</b>	0.5 V DC ... 9.5 V DC

## Electrical data

<b>Connection type</b>	Male connector, M12 type S (20x20 mm), 4-pin	
<b>PIN assignment</b>	1=V DC; 2=n.c.; 3=GND; 4=SIG	
<b>Electrical operation</b>	Supply voltage	24 V DC (8 ... 32 V DC)
	Residual ripple	< 1% S-S
	Power consumption	≤ 0.75 W
	Current consumption	≤ 30 mA
	Load resistance	RL ≥ 10 kΩ
<b>Overvoltage protection during power-up (60 s)</b>	≤ 36 V at all poles during power-up (60 s) ≤ 48 V To GND during power-up (60 s)	
<b>Reverse polarity protection</b>	≤ 36 V (at all poles) (ISO 16750-2)	
<b>Insulation resistance</b>	Riso ≥ 10 MΩ, 60 s (ISO 16750-2)	
<b>Dielectric strength</b>	500 V DC, 0 V DC (60 s) to housing (R <sub>ISO</sub> ≥ 1 MΩ) (ISO 16750-2)	
<b>Short-circuit protection</b>	V <sub>S</sub> – GND on housing	

## Mechanical data

<b>Dimensions</b>	Housing	48 mm, 48f7 for IN cylinder mounting – cylinder bore hole 48H8
	∅ pressure pipe	10 mm
	∅ O-ring	40.87 mm x 3.53 mm
	∅ support ring	42.6 mm x 48 mm x 1.4 mm
	M12 flange	M12 flange type S: DM 20x20 mm - hole pattern 14 mm (EN 61076-2-101)

	Wire length	80 mm
<b>Material</b>	Housing	Stainless steel 1.4305 (AISI 303)
	Pressure pipe	Stainless steel 1.4404, AISI 316L
	O-ring	NBR 70
	Support ring	PTFE
	M12 male connector	Glass fiber reinforced polyamide, nickel-/gold-plated brass contacts
	M12 flange	Nickel-plated brass with O-ring (NBR)
	Strands	PVC

### Ambient data

<b>EMC</b>		EU Directive 2014/30 / EU CE marking
	Generic standards	EN 61000-6-2/61000-6-3
	Agricultural and forestry machinery	EN ISO 14982
	Transient pulses	ISO 7637-2/ISO 16750-2
	ESD (air and contact discharge)	ISO 61000-4-2 / ISO 10605
<b>Vibration</b>	Sine	20 g (sine) / 55 ... 2,000 Hz / 3x24 h (IEC 60068-2-6 Fc)
	Sine over noise	18 g (r.m.s) / 10 ... 2,000 Hz / 3x36 h (IEC 60068-2-80 Fi)
	Broadband noise (resonance peaks removed)	20 g (r.m.s) / 10 ... 2,000 Hz / 3x48 h (IEC 60068-2-64 Fh)
<b>Pressure load</b>	Operating pressure $P_N$	400 bar
	Overload pressure $P_{max} = P_N \times 1.2$	480 bar
	Test pressure $P_{stat} = P_N \times 1.5$	600 bar
<b>Temperature and air humidity</b>	Storage	-20 °C ... +65 °C <sup>1)</sup>
	Operation (electronics)	-40 °C ... +105 °C <sup>2)</sup>
	Maximum air humidity	90 % (Condensation not permitted)
<b>Enclosure rating</b>	Housing	IP67 (EN 60529)
	M12 male connector	IP69K (ISO 20653) <sup>3)</sup>

<sup>1)</sup> R. H. 55%.

<sup>2)</sup> Taking into account self-heating, generated through constant electrical operation with supply voltage.

<sup>3)</sup> With suitable coupling (sealing through O-ring in M12 coupling nut).

### Classifications

<b>ECLASS 5.0</b>	27270705
<b>ECLASS 5.1.4</b>	27270705
<b>ECLASS 6.0</b>	27270705
<b>ECLASS 6.2</b>	27270705
<b>ECLASS 7.0</b>	27270705
<b>ECLASS 8.0</b>	27270705
<b>ECLASS 8.1</b>	27270705
<b>ECLASS 9.0</b>	27270705

<b>ECLASS 10.0</b>	27270705
<b>ECLASS 11.0</b>	27270705
<b>ECLASS 12.0</b>	27274304
<b>ETIM 5.0</b>	EC002544
<b>ETIM 6.0</b>	EC002544
<b>ETIM 7.0</b>	EC002544
<b>ETIM 8.0</b>	EC002544
<b>UNSPSC 16.0901</b>	41111613

**Dimensional drawing** (Dimensions in mm (inch))

MAX48



- ① Measuring range
- ② Damping zone
- ③ Position magnet

Male connector M12

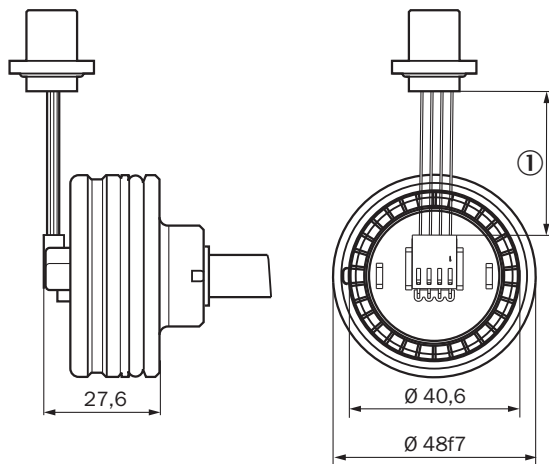

- ① Wire length (according to type code)

M12 connector type S/ flange - axial seal



Installation of position magnet



- ① Corrugated spring washer
- ② Position magnet
- ③ Circlip
- ④ Piston

Position magnet



Circlip



Corrugated spring washer



① Free height

### Attachment specifications

Installation space for cylinders





Please note the information in the operating instructions ( $d: 32 \leq d1 \leq 40$ ).

- ① Measuring range
- ② Damping zone
- ③ Hydraulic port





	Brief description	Type	Part no.
<b>Flanges</b>			
	1 piece, Flange for M12 male connector, type S square flange (20 mm x 20 mm) with axial seal, 1 piece, nickel-plated brass	BEF-FA-M12S-01	2117507
	5 pieces, Flange for M12 male connector, type S square flange (20 mm x 20 mm) with axial seal, 5 pieces, nickel-plated brass	BEF-FA-M12S-05	2117508
	10 pieces, Flange for M12 male connector, type S square flange (20 mm x 20 mm) with axial seal, 10 pieces, nickel-plated brass	BEF-FA-M12S-10	2117509
<b>Other mounting accessories</b>			
	1 piece, Retaining ring for installing the position magnets in the piston of the hydraulic cylinder, Stainless steel 1.4319	BEF-MK-SR-01	2116437
	5 pieces, Retaining ring for installing the position magnets in the piston of the hydraulic cylinder, Stainless steel 1.4319	BEF-MK-SR-05	2116438
	10 pieces, Retaining ring for installing the position magnets in the piston of the hydraulic cylinder, Stainless steel 1.4319	BEF-MK-SR-10	2116439
	50 pieces, Retaining ring for installing the position magnets in the piston of the hydraulic cylinder, Stainless steel 1.4319	BEF-MK-SR-50	2116440
	1 piece, Corrugated spring washer for installing the position magnets in the piston of the hydraulic cylinder, 1.4568 (17-7 PH Condition CH900)	BEF-MK-WF-01	2116431
	5 pieces, Corrugated spring washer for installing the position magnets in the piston of the hydraulic cylinder, 1.4568 (17-7 PH Condition CH900)	BEF-MK-WF-05	2116432
	10 pieces, Corrugated spring washer for installing the position magnets in the piston of the hydraulic cylinder, 1.4568 (17-7 PH Condition CH900)	BEF-MK-WF-10	2116433
	50 pieces, Corrugated spring washer for installing the position magnets in the piston of the hydraulic cylinder, 1.4568 (17-7 PH Condition CH900)	BEF-MK-WF-50	2116435

## SICK AT A GLANCE

SICK is one of the leading manufacturers of intelligent sensors and sensor solutions for industrial applications. A unique range of products and services creates the perfect basis for controlling processes securely and efficiently, protecting individuals from accidents and preventing damage to the environment.

We have extensive experience in a wide range of industries and understand their processes and requirements. With intelligent sensors, we can deliver exactly what our customers need. In application centers in Europe, Asia and North America, system solutions are tested and optimized in accordance with customer specifications. All this makes us a reliable supplier and development partner.

Comprehensive services complete our offering: SICK LifeTime Services provide support throughout the machine life cycle and ensure safety and productivity.

For us, that is “Sensor Intelligence.”

## WORLDWIDE PRESENCE:

Contacts and other locations –[www.sick.com](http://www.sick.com)