



MICS3-CCAZ90LZ1P01

microScan3

SAFETY LASER SCANNERS

SICK
Sensor Intelligence.



Illustration may differ



Ordering information

| Integration in the control system | Sub product family | Protective field range | Number of fields | Number of monitoring cases | Connection type | Type | Part no. |
|-----------------------------------|------------------------------|------------------------|------------------|----------------------------|----------------------------|------------------------|----------|
| PROFINET PROFIsafe | microScan3 Pro - PROFINET | 9 m | 128 | 128 | SCRJ push- pull AIDA | MICS3- CCAZ90LZ1P01 | 1100402 |

The system plug is pre-assembled on the underside. It can either be mounted on the rear side or the underside.

Other models and accessories → www.sick.com/microScan3

Detailed technical data

Features

| | |
|--|---|
| Sub product family | microScan3 Pro - PROFINET |
| Model | Sensor including system plug (pre-mounted on the underside) |
| Application | Indoor |
| Protective field range | 9 m |
| Warning field range | 64 m |
| Collision protection field range | 19 m (on reference target) |
| Number of simultaneously monitored fields | ≤ 4 ¹⁾ |
| Number of fields | 128 |
| Number of monitoring cases | 128 |
| Scanning angle | 275° |
| Resolution (can be configured) | 30 mm 40 mm 50 mm 60 mm 70 mm 150 mm 200 mm |
| Angular resolution | 0.1° |
| Response time | 115 ms |
| Protective field supplement | 100 mm |

¹⁾ Protection, warning or contour detection fields.

Safety-related parameters

| | |
|-------------------------------|--------------------|
| Type | Type 3 (IEC 61496) |
| Safety integrity level | SIL 2 (IEC 61508) |

| | |
|---|---|
| Category | Category 3 (EN ISO 13849) |
| Performance level | PL d (EN ISO 13849) |
| PFH_D (mean probability of a dangerous failure per hour) | 8.0 x 10 ⁻⁸ |
| T_M (mission time) | 20 years (EN ISO 13849) |
| Safe state in the event of a fault | The safety outputs via the network are logic 0. |

Functions

| | |
|--|--------------|
| Restart interlock | ✓ |
| Multiple sampling | ✓ |
| Monitoring case switching | ✓ |
| Simultaneous monitoring | ✓ |
| Static protective field switching | ✓ |
| Collision protection field | ✓ |
| Safe contour detection | ✓ |
| Contour as a reference | ✓ |
| Integrated configuration memory | ✓ |
| Measured data output | Via Ethernet |

Interfaces

| | |
|--|---|
| Connection type | |
| Voltage supply | 1 x male connector, M12, 5-pin, L-coded |
| Fieldbus, industrial network | 2 x SCRJ female connector for push-pull male connector (optical fibers) |
| Outputs | |
| OSSD pairs | 0 |
| Safety outputs via network | 8 |
| Configuration method | PC with Safety Designer (Configuration and Diagnostic Software) |
| Configuration and diagnostics interface | USB 2.0, Mini-USB, Ethernet |
| Fieldbus, industrial network | PROFINET |
| Protocol | PROFIsafe |
| Supported protocol versions | PROFINET specification V2.3 PROFIsafe profile in accordance with specification V2.6.1 PROFIsafe profile in accordance with specification V2.4 |
| GSDML | According to GSDML specification V2.33 |
| Cycle time | 1 ms, 2 ms, 4 ms, 8 ms, 16 ms ... |
| Conformance | Conformance Class C |
| Network management | SNMP MIB-2 LLDP in accordance with IEEE 802.1AB MRP client support |
| Net load | Net load class III in accordance with security level 1 test |
| Switch properties | 2 port real-time switch compliant with IEEE 802 |
| Port properties | 100BASE-POF |
| Diagnostics | I&M data sets 0 ... 5 PROFINET alarms Diagnostics of attenuation via POF |
| Additional services | PROFIenergy |

| | |
|-------------------------|--|
| | F_iPar_CRC Acyclic read-/write services for communication via TCI SNTP (client and server) |
| Additional interfaces | TCP/IP communication via port 9000 |
| Display elements | Graphic color display, LEDs |

Electrical data

| | |
|-------------------------------------|---------------------------------|
| Protection class | III (EN 61140) |
| Supply voltage V_s | 24 V DC (16.8 V DC ... 30 V DC) |
| Power consumption typical | 8.4 W |

Mechanical data

| | |
|------------------------------------|--|
| Dimensions (W x H x D) | 112 mm x 163.1 mm x 111.1 mm (without system plug) |
| Weight | 1.65 kg |
| Housing material | Aluminum |
| Housing color | RAL 1021 (yellow), RAL 9005 (black) |
| Optics cover material | Polycarbonate |
| Optics cover surface finish | Outside with scratch-resistant coating |

Ambient data

| | |
|--------------------------------------|--|
| Enclosure rating | IP65 (IEC 60529) |
| Ambient light immunity | 3,000 lx (IEC 61496-3) |
| Ambient operating temperature | -10 °C ... +50 °C |
| Storage temperature | -25 °C ... +70 °C |
| Vibration resistance | IEC 60068-2-6, IEC 60068-2-64, IEC 60721-3-5, IEC TR 60721-4-3, IEC 61496-1, IEC 61496-3 |
| | Class 5M1 (IEC 60721-3-5) 3M4 (IEC TR 60721-4-3) |
| Shock resistance | IEC 60068-2-27, IEC 60721-3-5, IEC TR 60721-4-3, IEC 61496-1, IEC 61496-3 |
| | Class 5M1 (IEC 60721-3-5) 3M4 (IEC TR 60721-4-3) |
| | Continuous shock 100 m/s ² , 16 ms 150 m/s ² , 6 ms |
| EMC | IEC 61496-1, IEC 61000-6-2, IEC 61000-6-4 |

Other information

| | |
|------------------------------------|---|
| Type of light | Pulsed laser diode |
| Wave length | 845 nm |
| Detectable remission factor | 1.8% to several 1000% |
| Laser class | 1 (21 CFR 1040.10 and 1040.11, IEC 60825-1) |

Classifications

| | |
|---------------------|----------|
| ECLASS 5.0 | 27272705 |
| ECLASS 5.1.4 | 27272705 |
| ECLASS 6.0 | 27272705 |
| ECLASS 6.2 | 27272705 |
| ECLASS 7.0 | 27272705 |
| ECLASS 8.0 | 27272705 |

| | |
|-----------------------|----------|
| ECLASS 8.1 | 27272705 |
| ECLASS 9.0 | 27272705 |
| ECLASS 10.0 | 27272705 |
| ECLASS 11.0 | 27272705 |
| ECLASS 12.0 | 27272705 |
| ETIM 5.0 | EC002550 |
| ETIM 6.0 | EC002550 |
| ETIM 7.0 | EC002550 |
| ETIM 8.0 | EC002550 |
| UNSPSC 16.0901 | 39121528 |

Dimensional drawing (Dimensions in mm (inch))

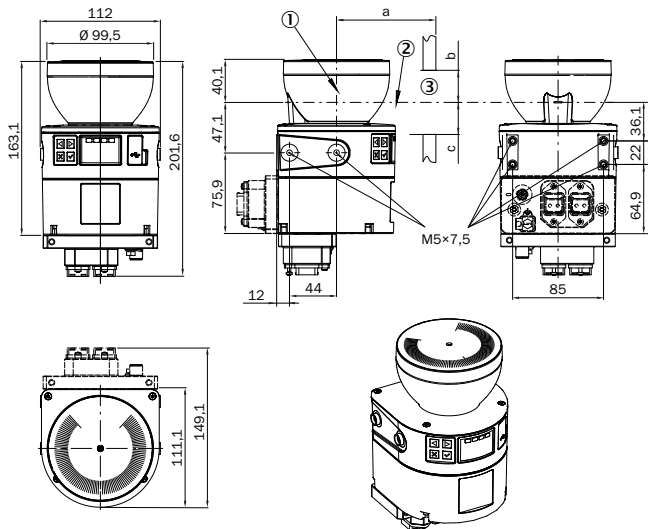

- ① Mirror axis of rotation
- ② Scan plane
- ③ Required viewing slit (a: length of the viewing slit, b: minimum height above the scan plane, c: minimum height below the scan plane. See the operating instructions for details.)

Pinouts

Ethernet

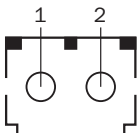

| Pin | Designation | Description |
|-----|-------------|----------------|
| 1 | TX | Send data |
| 2 | RX+ | Receive data + |

For details see operating instructions

Voltage supply

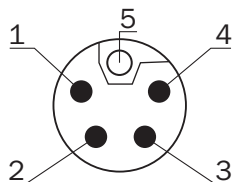













| Pin | Designation | Description |
|-----|-------------|----------------------------|
| 1 | +24 V DC | Supply voltage +24 V DC |
| 2 | n.c. | Not connected |
| 3 | 0 V DC | Supply voltage 0 V DC |
| 4 | n.c. | Not connected |
| 5 | FE | Functional earth/shielding |

For details see operating instructions

Recommended accessories

Other models and accessories → www.sick.com/microScan3

| | Brief description | Type | Part no. |
|---|--|--|----------|
| Mounting brackets and plates | | | |
|  | 1 piece, mounting bracket with protection of optics hood, Stainless steel V2A (1.4301), powder-coated IGP-DURA face 5803A | 1b mounting kit | 2074242 |
|  | 1 piece, mounting bracket, heavy-duty version, with protection cover, for floor mounting, height adjustment possible from 90 ... 310 mm, scanner tilt angle: ± 5°. Additional mounting brackets are not required. ☹, steel, painted (RAL 1021) | Heavy-duty mounting kit for floor mounting | 2102289 |
|  | 1 piece, mounting bracket 150 mm for floor mounting of microScan3, stainless steel, Bracket and 4 x M5 screws for attaching the microScan3 | Mounting bracket 150 mm for floor mounting of microScan3 | 2112950 |
|  | 1 piece, mounting bracket 300 mm for floor mounting of microScan3, stainless steel, Bracket and 4 x M5 screws for attaching the microScan3 | Mounting bracket 300 mm for floor mounting of microScan3 | 2112951 |
|  | 1 piece, mounting bracket, Stainless steel V2A (1.4301), powder-coated IGP-DURA face 5803A | Mounting kit 1a | 2073851 |
|  | 1 piece, alignment bracket, alignment with cross-wise axis and depth axis possible, distance between mounting surface and device: 22.3 mm, only in conjunction with mounting kit 1a (2073851) or 1b (2074242), Stainless steel V2A (1.4301), powder-coated IGP-DURA face 5803A | Mounting kit 2a | 2073852 |
|  | 1 piece, Alignment bracket, alignment with cross-wise axis and depth axis possible, distance between mounting surface and device: 52.3 mm, only in conjunction with mounting kit 1a (2073851) or 1b (2074242), Stainless steel V2A (1.4301), powder-coated IGP-DURA face 5803A | Mounting kit 2b | 2074184 |

| | Brief description | Type | Part no. |
|---|---|--------------------|----------|
| Others | | | |
|  | <ul style="list-style-type: none"> • Brief description: The software visualizes diagnostic and device information from safety laser scanners in real time, helping to identify error causes faster and reduce maintenance time. • Supported products: All microScan3 variants (except for microScan3 Core I/O variants), outdoorScan3 Pro - EtherNet/IP • Version: 1.0 • Note: With purchase, you accept the product description available under Downloads > Documentation in connection with the https://www.sick.com/tools/tac/en/General-Terms-Conditions-Supply-Software-Products-AVB-Software-SICK.pdf target="_blank">General Terms and Conditions for the Supply of Software Products (AVB Software SICK)., With purchase, you accept the product description available under Downloads > Documentation in connection with the https://www.sick.com/tools/tac/en/General-Terms-Conditions-Supply-Software-Products-AVB-Software-SICK.pdf target="_blank">General Terms and Conditions for the Supply of Software Products (AVB Software SICK). | SOW/VTL-LI007PCWIO | 1116788 |
|  | <ul style="list-style-type: none"> • Connection type head A: Female connector, M12, 5-pin, straight, L-coded • Connection type head B: Flying leads • Signal type: Sensor/actuator cable • Cable: 2 m, 5-wire, PUR, halogen-free • Description: Sensor/actuator cable, unshielded • Application: Drag chain operation | YF2L15-020UH1XLEAX | 2099599 |
|  | <ul style="list-style-type: none"> • Connection type head A: Female connector, M12, 5-pin, straight, L-coded • Connection type head B: Flying leads • Signal type: Sensor/actuator cable • Cable: 5 m, 5-wire, PUR, halogen-free • Description: Sensor/actuator cable, unshielded • Application: Drag chain operation | YF2L15-050UH1XLEAX | 2099626 |
|  | <ul style="list-style-type: none"> • Connection type head A: Female connector, M12, 5-pin, straight, L-coded • Connection type head B: Flying leads • Signal type: Sensor/actuator cable • Cable: 10 m, 5-wire, PUR, halogen-free • Description: Sensor/actuator cable, unshielded • Application: Drag chain operation | YF2L15-100UH1XLEAX | 2099627 |
|  | <ul style="list-style-type: none"> • Connection type head A: Female connector, M12, 5-pin, straight, L-coded • Connection type head B: Flying leads • Signal type: Sensor/actuator cable • Cable: 20 m, 5-wire, PUR, halogen-free • Description: Sensor/actuator cable, unshielded • Application: Drag chain operation | YF2L15-200UH1XLEAX | 2099628 |
|  | <ul style="list-style-type: none"> • Connection type head A: Push-pull male connector, M12, L-coded • Description: Adapter for the series voltage supply connection of microScan3 – PROFINET devices. Connection to the system plug of the safety laser scanner. | Push-pull adapter | 2098095 |

SICK AT A GLANCE

SICK is one of the leading manufacturers of intelligent sensors and sensor solutions for industrial applications. A unique range of products and services creates the perfect basis for controlling processes securely and efficiently, protecting individuals from accidents and preventing damage to the environment.

We have extensive experience in a wide range of industries and understand their processes and requirements. With intelligent sensors, we can deliver exactly what our customers need. In application centers in Europe, Asia and North America, system solutions are tested and optimized in accordance with customer specifications. All this makes us a reliable supplier and development partner.

Comprehensive services complete our offering: SICK LifeTime Services provide support throughout the machine life cycle and ensure safety and productivity.

For us, that is “Sensor Intelligence.”

WORLDWIDE PRESENCE:

Contacts and other locations –www.sick.com