



# MLG02A-0595R53201

MLG-2

MEASURING AUTOMATION LIGHT GRIDS

**SICK**  
Sensor Intelligence.



Illustration may differ

### Ordering information

Type	Part no.
MLG02A-0595R53201	1138386

Other models and accessories → [www.sick.com/MLG-2](http://www.sick.com/MLG-2)



### Detailed technical data

#### Features

<b>Device version</b>	Pro - Advanced functionality										
<b>Sensor principle</b>	Sender/receiver										
<b>Minimum detectable object (MDO)</b>	2.5 mm, 4.5 mm <sup>1) 2) 3)</sup>										
<b>Beam separation</b>	2.5 mm										
<b>Type of synchronization</b>	Cable										
<b>Number of beams</b>	239										
<b>Detection height</b>	595 mm										
<b>Software features (default)</b>	<table border="0"> <tr> <td>Q<sub>1</sub></td> <td>Presence detection</td> </tr> <tr> <td>Q<sub>2</sub> / IN</td> <td>Teach input</td> </tr> <tr> <td>Q<sub>3</sub></td> <td>Presence detection</td> </tr> <tr> <td>Q<sub>4</sub> / IN2</td> <td>Presence detection</td> </tr> <tr> <td>Teach</td> <td>Standard mode</td> </tr> </table>	Q <sub>1</sub>	Presence detection	Q <sub>2</sub> / IN	Teach input	Q <sub>3</sub>	Presence detection	Q <sub>4</sub> / IN2	Presence detection	Teach	Standard mode
Q <sub>1</sub>	Presence detection										
Q <sub>2</sub> / IN	Teach input										
Q <sub>3</sub>	Presence detection										
Q <sub>4</sub> / IN2	Presence detection										
Teach	Standard mode										
<b>Operating mode</b>	<table border="0"> <tr> <td>Standard</td> <td>✓</td> </tr> <tr> <td>Transparent</td> <td>✓</td> </tr> <tr> <td>Dust- and sunlight-resistant</td> <td>✓</td> </tr> </table>	Standard	✓	Transparent	✓	Dust- and sunlight-resistant	✓				
Standard	✓										
Transparent	✓										
Dust- and sunlight-resistant	✓										
<b>Function</b>	<table border="0"> <tr> <td>Cross beam</td> <td>✓</td> </tr> <tr> <td>Beam blanking</td> <td>✓</td> </tr> </table>	Cross beam	✓	Beam blanking	✓						
Cross beam	✓										
Beam blanking	✓										

<sup>1)</sup> MDO min. detectable object at high measurement accuracy.

<sup>2)</sup> MDO min. detectable object for standard measurement accuracy.

<sup>3)</sup> Depending on beam separation without cross beam setting.

High-speed scan	✓
High measurement accuracy	✓
<b>Applications</b>	
Switching output	Object recognition/object width Object recognition Height classification Hole detection/hole size Outside dimension/inside dimension Object position Hole position Zone definition
Data interface	Object detection Hole detection Object height measurement Measurement of external dimension Measurement of inside dimension Measurement of object position Measurement of hole position
<b>Included with delivery</b>	1 × sender (in IP69K protective pipes) 1 × receiver (in IP69K protective pipes) 1 × IP69K mounting instructions 1 × Quick Start Guide

- 1) MDO min. detectable object at high measurement accuracy.  
 2) MDO min. detectable object for standard measurement accuracy.  
 3) Depending on beam separation without cross beam setting.

### Mechanics/electronics

<b>Light source</b>	LED, Infrared light
<b>Wave length</b>	850 nm
<b>Supply voltage <math>V_s</math></b>	DC 19.2 V ... 28.8 V <sup>1)</sup>
<b>Power consumption sender</b>	67.9 mA <sup>2)</sup>
<b>Power consumption receiver</b>	168.6 mA <sup>2)</sup>
<b>Ripple</b>	< 5 V <sub>pp</sub>
<b>Output current <math>I_{max.}</math></b>	100 mA
<b>Output load, capacitive</b>	100 nF
<b>Output load, Inductive</b>	1 H
<b>Initialization time</b>	< 1 s
<b>Switching output</b>	Push-pull: PNP/NPN
<b>Connection type</b>	Male connector M12, 5-pin, 0.39 m Male connector M12, 8-pin, 0.39 m
<b>Housing material</b>	Aluminum (light grid) PMMA Plexiglas XT Food Contact DoC (protective pipe) Polypropylene, stainless steel 1.4404 (cable) VA 1.4305 (pressure compensation element) Stainless steel 1.4404 (end caps) Stainless steel V4A 1.4404 DIN EN 1672-2 (cable gland)
<b>Indication</b>	LED
<b>Enclosure rating</b>	IP69K <sup>3)</sup>

- 1) Without load.  
 2) Without load with 24 V.  
 3) Operating in outdoor condition only with a external protection housing.

<b>Circuit protection</b>	U <sub>V</sub> connections, reverse polarity protected Output Q short-circuit protected Interference pulse suppression
<b>Protection class</b>	III
<b>Weight</b>	1.76 kg
<b>Option</b>	Protective housing IP69K
<b>UL File No.</b>	NRKH.E181493

- <sup>1)</sup> Without load.
- <sup>2)</sup> Without load with 24 V.
- <sup>3)</sup> Operating in outdoor condition only with a external protection housing.

### Performance

<b>Maximum range</b>	2.1 m <sup>1)</sup>
<b>Minimum range</b>	≥ 0 m
<b>Operating range</b>	1.5 m
<b>Response time</b>	3.7 ms <sup>2)</sup>

- <sup>1)</sup> No reserve for environmental issue and deterioration of the diode.
- <sup>2)</sup> Without high speed.

### Communication interface

<b>IO-Link</b>	✓, IO-Link V1.1
Data transmission rate	230,4 kbit/s (COM3)
Maximum cable length	20 m
Cycle time	2.3 ms
VendorID	26
DeviceID HEX	800068
DeviceID DEC	8388712
Process data length	32 Byte (TYPE_2_V) <sup>1)</sup>
<b>Inputs/outputs</b>	4 x Q (IO-Link)
<b>Digital output</b>	Q <sub>1</sub> ... Q <sub>4</sub>
Number	4
<b>Digital input</b>	In <sub>1</sub> , In <sub>2</sub>
Number	2

- <sup>1)</sup> With an IO-Link master with V1.0, fall back to interleaved mode (consisting of TYPE\_1\_1 (ProcessData) and TYPE\_1\_2 (On-request Data)).

### Ambient data

<b>Shock resistance</b>	Continuous shocks 10 g, 16 ms, 1000 shocks Single shocks 15 g, 11 ms 3 per axle
<b>Vibration resistance</b>	Sinusoidal oscillation 10-150 Hz 5 g
<b>EMC</b>	EN 60947-5-2
<b>Ambient light immunity</b>	Direct: 150,000 lx <sup>1)</sup> Indirect: 200,000 lx <sup>2)</sup>
<b>Ambient operating temperature</b>	-20 °C ... +55 °C

- <sup>1)</sup> Outdoor mode.
- <sup>2)</sup> Light resistance indirect.

<b>Ambient temperature, storage</b>	-40 °C ... +70 °C
-------------------------------------	-------------------

1) Outdoor mode.

2) Light resistance indirect.

### Smart Task

<b>Smart Task name</b>	Base logics
------------------------	-------------

### Classifications

<b>ECLASS 5.0</b>	27270910
<b>ECLASS 5.1.4</b>	27270910
<b>ECLASS 6.0</b>	27270910
<b>ECLASS 6.2</b>	27270910
<b>ECLASS 7.0</b>	27270910
<b>ECLASS 8.0</b>	27270910
<b>ECLASS 8.1</b>	27270910
<b>ECLASS 9.0</b>	27270910
<b>ECLASS 10.0</b>	27270910
<b>ECLASS 11.0</b>	27270910
<b>ECLASS 12.0</b>	27270910
<b>ETIM 5.0</b>	EC002549
<b>ETIM 6.0</b>	EC002549
<b>ETIM 7.0</b>	EC002549
<b>ETIM 8.0</b>	EC002549
<b>UNSPSC 16.0901</b>	39121528

Dimensional drawing (Dimensions in mm (inch))

Dimensional drawing

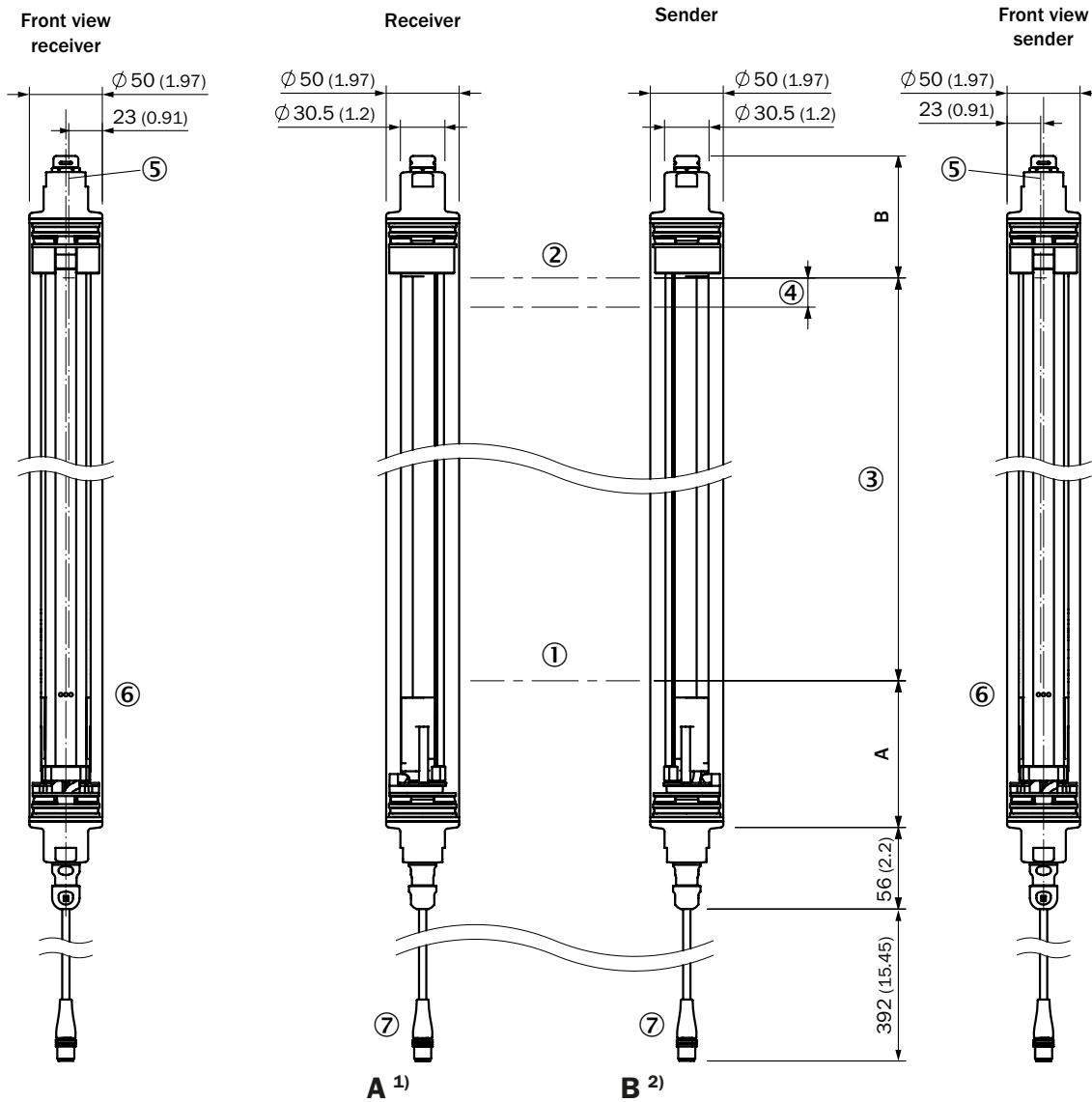

<b>Beam separation 2.5 mm</b>	94.25 (3.71)	84.7 (3.33)
<b>Beam separation 5 mm</b>	95.5 (3.76)	83.6 (3.29)
<b>Beam separation 10 mm</b>	100.5 (3.96)	83.6 (3.29)
<b>Beam separation 20 mm</b>	100.5 (3.96)/110.5 (4.35) <sup>3)</sup>	83.6 (3.29)
<b>Beam separation 25 mm</b>	115.5 (4.55)	83.6 (3.29)
<b>Beam separation 30 mm</b>	120.5 (4.74)	83.6 (3.29)
<b>Beam separation 50 mm</b>	140.5 (5.53)	83.6 (3.29)

<sup>1)</sup> Distance: MLG-2 edge - first beam

<sup>2)</sup> Distance: MLG-2 edge - last beam

<sup>3)</sup> MLG20x-xx**40**: 100.5 mm  
MLG20x-xx**80**: 110.5 mm

- ① First beam
- ② Last beam
- ③ Detection height (see technical data)
- ④ Beam separation
- ⑤ Optical axis
- ⑥ Status indicator: green, yellow, red LEDs
- ⑦ Connection

**Connection type and diagram**

M12 male connector, 5/8-pin, switching outputs Q | YF2AP8-xxxPA4XLEAX (IP69K connecting cable)

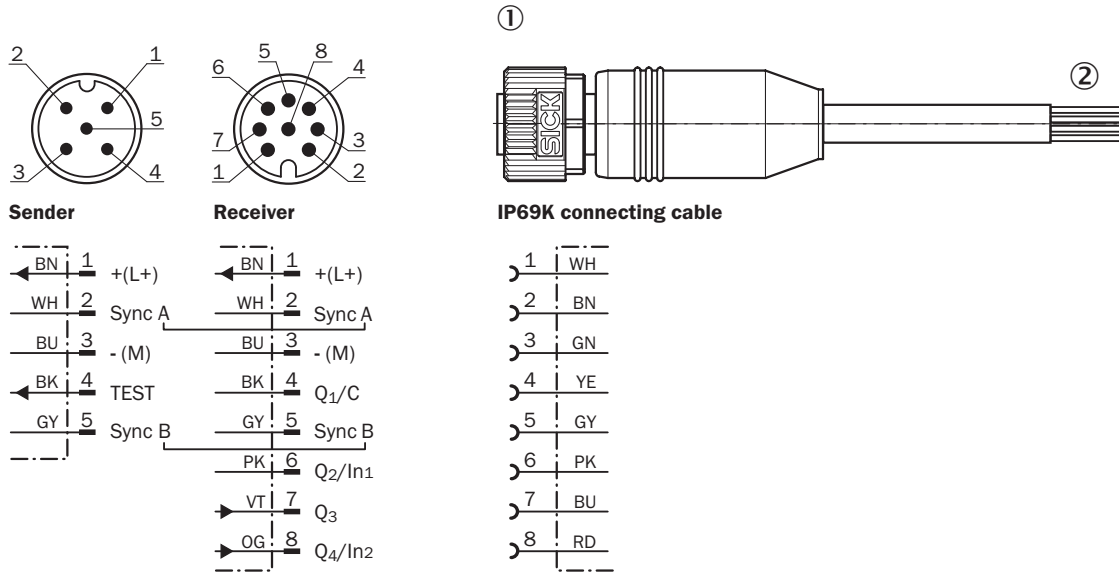

① Valid for: YF2AP8-250PA4XLEAX (2116447), YF2AP8-020PA4XLEAX (2111888)

② For 8-pin sensor-actuator cables, the wire colors are not standardized. Therefore, please observe the pin assignment of the sensor and the cable in the respective data sheet.

Pinouts

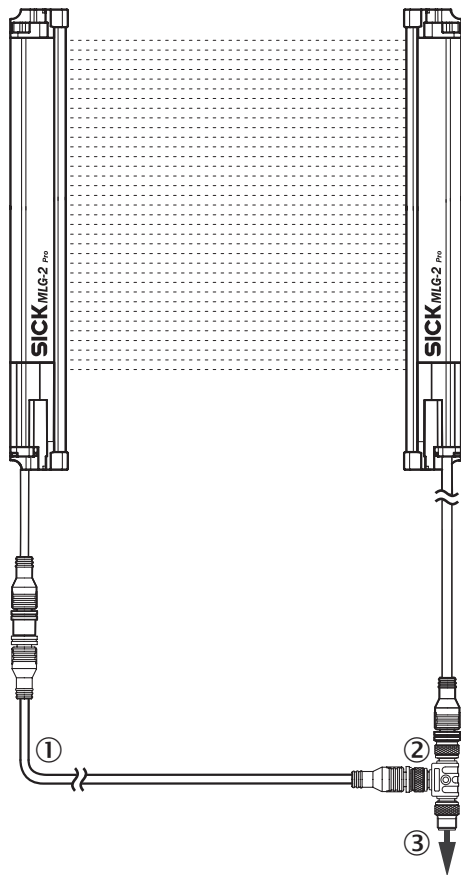

- ① Connection cable receiver (2096010)
- ② T-junctions
- ③ Connection cable (6020664)



## Adjustments

### Adjustments



① Status indicator: green, yellow, red LEDs

## Connection diagram

### T-junction, PLC







T-junction, IO-Link-Master



Recommended accessories

Other models and accessories → [www.sick.com/MLG-2](http://www.sick.com/MLG-2)

	Brief description	Type	Part no.
Terminal and alignment brackets			
	4 pieces, Stainless steel bracket, rotatable, stainless steel 1.4350, stainless steel 1.4301	BEF-2SMMEAES4	2023708
Others			
	<ul style="list-style-type: none"> <li><b>Connection type head A:</b> Female connector, M12, 5-pin, A-coded</li> <li><b>Connection type head B:</b> Female connector, M12, 8-pin, A-coded</li> <li><b>Connection type head C:</b> Male connector, M12, 8-pin, A-coded</li> <li><b>Note:</b> Male connector M12, 8-pin, to 1 x female connector M12, 8-pin, to 1 female connector M12, 5-pin, for connecting of a PLC</li> </ul>	SBO-02F12-SM1	6053172
	<ul style="list-style-type: none"> <li><b>Connection type head A:</b> Female connector, M12, 8-pin, straight</li> <li><b>Connection type head B:</b> Flying leads</li> <li><b>Signal type:</b> Sensor/actuator cable</li> <li><b>Cable:</b> 5 m, 8-wire, PVC</li> <li><b>Description:</b> Sensor/actuator cable, special color code, shielded</li> <li><b>Connection systems:</b> Flying leads</li> </ul>	DOL-1208-G05MF	6020664
	<ul style="list-style-type: none"> <li><b>Connection type head A:</b> Female connector, M12, 5-pin, straight, A-coded</li> <li><b>Connection type head B:</b> Male connector, M12, 5-pin, straight, A-coded</li> <li><b>Signal type:</b> Sensor/actuator cable</li> <li><b>Cable:</b> 5 m, 5-wire, PUR, halogen-free</li> <li><b>Description:</b> Sensor/actuator cable, unshielded</li> <li><b>Application:</b> Zones with oils and lubricants, Drag chain operation, Robot</li> </ul>	YF2A15-050UB5M2A15	2096010
	YF2AP8-020PA4XLEAX	YF2AP8-020PA4XLEAX	2111888
	YF2AP8-250PA4XLEAX	YF2AP8-250PA4XLEAX	2116447

	Brief description	Type	Part no.
Sensor Integration Gateway			
	<ul style="list-style-type: none"> <li>• <b>Further functions:</b> Web server integrated, IIoT interface available (dual talk)</li> <li>• <b>Logic editor:</b> no</li> <li>• <b>Communication interface:</b> IO-Link, Ethernet, PROFINET, REST API, MQTT, OPC UA</li> <li>• <b>Product category:</b> IO-Link Master</li> </ul>	SIG350-0004AP100	6076871
	<ul style="list-style-type: none"> <li>• <b>Further functions:</b> Web server integrated, IIoT interface available (dual talk)</li> <li>• <b>Logic editor:</b> no</li> <li>• <b>Communication interface:</b> IO-Link, Ethernet, EtherNet/IP™, REST API, MQTT, OPC UA</li> <li>• <b>Product category:</b> IO-Link Master</li> </ul>	SIG350-0005AP100	6076923
	<ul style="list-style-type: none"> <li>• <b>Further functions:</b> Web server integrated, IIoT interface available (dual talk)</li> <li>• <b>Logic editor:</b> no</li> <li>• <b>Communication interface:</b> IO-Link, Ethernet, EtherCAT®, REST API, MQTT, OPC UA</li> <li>• <b>Product category:</b> IO-Link Master</li> </ul>	SIG350-0006AP100	6076924

## SICK AT A GLANCE

SICK is one of the leading manufacturers of intelligent sensors and sensor solutions for industrial applications. A unique range of products and services creates the perfect basis for controlling processes securely and efficiently, protecting individuals from accidents and preventing damage to the environment.

We have extensive experience in a wide range of industries and understand their processes and requirements. With intelligent sensors, we can deliver exactly what our customers need. In application centers in Europe, Asia and North America, system solutions are tested and optimized in accordance with customer specifications. All this makes us a reliable supplier and development partner.

Comprehensive services complete our offering: SICK LifeTime Services provide support throughout the machine life cycle and ensure safety and productivity.

For us, that is “Sensor Intelligence.”

## WORLDWIDE PRESENCE:

Contacts and other locations –[www.sick.com](http://www.sick.com)