



# MLG30S-2520D10501

MLG-2

MEASURING AUTOMATION LIGHT GRIDS

**SICK**  
Sensor Intelligence.



Illustration may differ



### Ordering information

Type	Part no.
MLG30S-2520D10501	1218849

Other models and accessories → [www.sick.com/MLG-2](http://www.sick.com/MLG-2)

### Detailed technical data

#### Features

<b>Device version</b>	Prime - Standard functionality
<b>Sensor principle</b>	Sender/receiver
<b>Minimum detectable object (MDO)</b>	34 mm <sup>1)</sup>
<b>Beam separation</b>	30 mm
<b>Type of synchronization</b>	Optical
<b>Number of beams</b>	85
<b>Detection height</b>	2,520 mm
<b>Software features (default)</b>	<ul style="list-style-type: none"> <li>Q<sub>1</sub> Auto-define height classification</li> <li>Q<sub>2</sub> / IN Auto-define height classification</li> <li>Q<sub>3</sub> Auto-define height classification</li> <li>inverted —</li> <li>Teach —</li> <li>key lock off</li> </ul>
<b>Operating mode</b>	Standard ✓
<b>Function</b>	<ul style="list-style-type: none"> <li>Cross beam ✓</li> <li>Beam blanking ✓</li> </ul>
<b>Applications</b>	Switching output Object detection

<sup>1)</sup> Depending on beam separation without cross beam setting.

	Object recognition Height classification
Data interface	Object detection Object height measurement
<b>Included with delivery</b>	1 × sender 1 × receiver 4/6 × QuickFix brackets (6 × QuickFix brackets for monitoring heights above 2 m) 1 × Quick Start Guide

<sup>1)</sup> Depending on beam separation without cross beam setting.

## Mechanics/electronics

<b>Light source</b>	LED, Infrared light
<b>Wave length</b>	850 nm
<b>Supply voltage <math>V_s</math></b>	DC 19.2 V ... 28.8 V <sup>1)</sup>
<b>Power consumption sender</b>	59.25 mA <sup>2)</sup>
<b>Power consumption receiver</b>	137 mA <sup>2)</sup>
<b>Ripple</b>	< 5 V <sub>pp</sub>
<b>Output current <math>I_{max}</math></b>	100 mA
<b>Output load, capacitive</b>	100 nF
<b>Output load, Inductive</b>	1 H
<b>Initialization time</b>	< 1 s
<b>Switching output</b>	Push-pull: PNP/NPN
<b>Connection type</b>	Male connector M12, 5-pin, 0.22 m Male connector M12, 5-pin, 0.22 m
<b>Housing material</b>	Aluminum
<b>Indication</b>	LED
<b>Enclosure rating</b>	IP65, IP67 <sup>3)</sup>
<b>Circuit protection</b>	U <sub>V</sub> connections, reverse polarity protected Output Q short-circuit protected Interference pulse suppression
<b>Protection class</b>	III
<b>Weight</b>	5.349 kg
<b>Front screen</b>	PMMA
<b>Option</b>	None
<b>UL File No.</b>	NRKH.E181493

<sup>1)</sup> Without load.

<sup>2)</sup> Without load with 24 V.

<sup>3)</sup> Operating in outdoor condition only with a external protection housing.

## Performance

<b>Maximum range</b>	7 m <sup>1)</sup>
<b>Minimum range</b>	≥ 0.2 m
<b>Operating range</b>	5 m
<b>Response time</b>	10.7 ms

<sup>1)</sup> No reserve for environmental issue and deterioration of the diode.

## Communication interface

<b>IO-Link</b>	✓, IO-Link V1.1
Data transmission rate	38,4 kbit/s (COM2)
Maximum cable length	20 m
Cycle time	6 ms
VendorID	26
DeviceID HEX	800067
DeviceID DEC	8388711
Process data length	6 Byte (TYPE_2_V) <sup>1)</sup>
<b>Inputs/outputs</b>	3 x Q (IO-Link)
<b>Digital output</b>	Q <sub>1</sub> ... Q <sub>3</sub>
Number	3
<b>Digital input</b>	In <sub>1</sub>
Number	1

<sup>1)</sup> With an IO-Link master with V1.0, fall back to interleaved mode (consisting of TYPE\_1\_1 (ProcessData) and TYPE\_1\_2 (On-request Data)).

## Ambient data

<b>Shock resistance</b>	Continuous shocks 10 g, 16 ms, 1000 shocks Single shocks 15 g, 11 ms 3 per axle
<b>Vibration resistance</b>	Sinusoidal oscillation 10-150 Hz 5 g
<b>EMC</b>	EN 60947-5-2
<b>Ambient light immunity</b>	Direct: 12,000 lx <sup>1)</sup> Indirect: 50,000 lx <sup>2)</sup>
<b>Ambient operating temperature</b>	-30 °C ... +55 °C
<b>Ambient temperature, storage</b>	-40 °C ... +70 °C

<sup>1)</sup> Outdoor mode.

<sup>2)</sup> Light resistance indirect.

## Smart Task

<b>Smart Task name</b>	Base logics
------------------------	-------------

## Classifications

<b>ECLASS 5.0</b>	27270910
<b>ECLASS 5.1.4</b>	27270910
<b>ECLASS 6.0</b>	27270910
<b>ECLASS 6.2</b>	27270910
<b>ECLASS 7.0</b>	27270910
<b>ECLASS 8.0</b>	27270910
<b>ECLASS 8.1</b>	27270910
<b>ECLASS 9.0</b>	27270910
<b>ECLASS 10.0</b>	27270910
<b>ECLASS 11.0</b>	27270910
<b>ECLASS 12.0</b>	27270910
<b>ETIM 5.0</b>	EC002549

<b>ETIM 6.0</b>	EC002549
<b>ETIM 7.0</b>	EC002549
<b>ETIM 8.0</b>	EC002549
<b>UNSPSC 16.0901</b>	39121528

Dimensional drawing (Dimensions in mm (inch))

Dimensional drawing



**A**<sup>1)</sup>

<b>Beam separation 5 mm</b>	63.3 (2.49)
<b>Beam separation 10 mm</b>	68.3 (2.69)
<b>Beam separation 20 mm</b>	68.3 (2.69)/78.3 (3.08) <sup>(2)</sup>
<b>Beam separation 25 mm</b>	83.3 (3.28)
<b>Beam separation 30 mm</b>	88.3 (3.48)
<b>Beam separation 50 mm</b>	108.3 (4.26)

<sup>1)</sup> Distance: MLG edge - first beam

<sup>2)</sup> MLG20x-xx**40**: 68.3 mm  
 MLG20x-xx**80**: 78.3 mm

- ① First beam
- ② Last beam
- ③ Detection height (see technical data)
- ④ Beam separation
- ⑤ Optical axis
- ⑥ Status indicator: green, yellow, red LEDs
- ⑦ Connection

## Connection type and diagram

Connector M12, 5-pin, switching outputs Q



### Sender



① Not assigned

### Receiver



## Adjustments

Adjustments

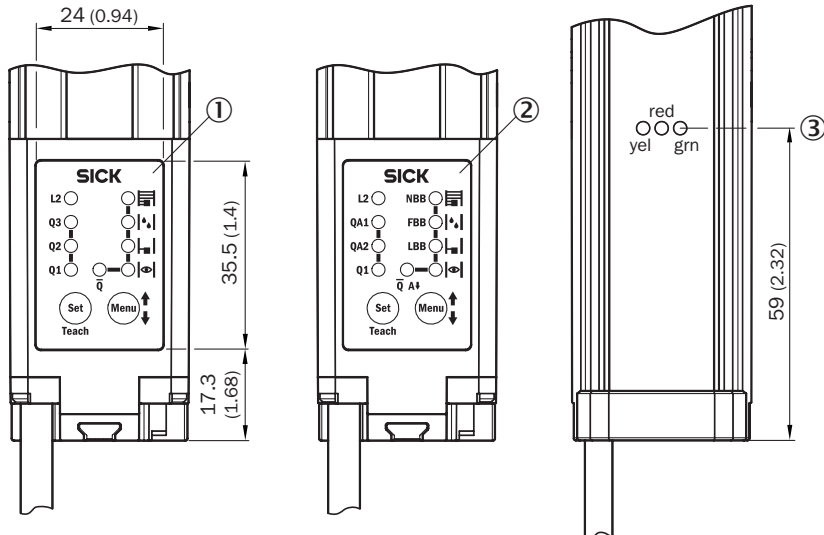

- ① MLG-2 with switching outputs Q
- ② MLG-2 with analog outputs Q<sub>A</sub>
- ③ Status indicator: green, yellow, red LEDs

## Functional principle

Optical synchronisation



The transmitter and receiver synchronize optically, so no electrical connection is required. For this reason, either the first or the last beam of the automation light grid must remain unobstructed. If both beams are interrupted, measurement is no longer possible.

- ① Optical synchronisation
- ② Detection height
- ③ Beam separation
- ④ Scanning range

## Recommended accessories

Other models and accessories → [www.sick.com/MLG-2](http://www.sick.com/MLG-2)

	Brief description	Type	Part no.
Others			
	<ul style="list-style-type: none"> <li>• <b>Connection type head A:</b> Female connector, M12, 5-pin, straight, A-coded</li> <li>• <b>Connection type head B:</b> Flying leads</li> <li>• <b>Signal type:</b> Sensor/actuator cable</li> <li>• <b>Cable:</b> 5 m, 5-wire, PVC</li> <li>• <b>Description:</b> Sensor/actuator cable, unshielded</li> <li>• <b>Application:</b> Zones with chemicals</li> </ul>	YF2A15-050VB5XLEAX	2096240
Sensor Integration Gateway			
	<ul style="list-style-type: none"> <li>• <b>Further functions:</b> Web server integrated, IIoT interface available (dual talk)</li> <li>• <b>Logic editor:</b> no</li> <li>• <b>Communication interface:</b> IO-Link, Ethernet, PROFINET, REST API, MQTT, OPC UA</li> <li>• <b>Product category:</b> IO-Link Master</li> </ul>	SIG350-0004AP100	6076871
	<ul style="list-style-type: none"> <li>• <b>Further functions:</b> Web server integrated, IIoT interface available (dual talk)</li> <li>• <b>Logic editor:</b> no</li> <li>• <b>Communication interface:</b> IO-Link, Ethernet, EtherNet/IP™, REST API, MQTT, OPC UA</li> <li>• <b>Product category:</b> IO-Link Master</li> </ul>	SIG350-0005AP100	6076923
	<ul style="list-style-type: none"> <li>• <b>Further functions:</b> Web server integrated, IIoT interface available (dual talk)</li> <li>• <b>Logic editor:</b> no</li> <li>• <b>Communication interface:</b> IO-Link, Ethernet, EtherCAT®, REST API, MQTT, OPC UA</li> <li>• <b>Product category:</b> IO-Link Master</li> </ul>	SIG350-0006AP100	6076924



## SICK AT A GLANCE

SICK is one of the leading manufacturers of intelligent sensors and sensor solutions for industrial applications. A unique range of products and services creates the perfect basis for controlling processes securely and efficiently, protecting individuals from accidents and preventing damage to the environment.

We have extensive experience in a wide range of industries and understand their processes and requirements. With intelligent sensors, we can deliver exactly what our customers need. In application centers in Europe, Asia and North America, system solutions are tested and optimized in accordance with customer specifications. All this makes us a reliable supplier and development partner.

Comprehensive services complete our offering: SICK LifeTime Services provide support throughout the machine life cycle and ensure safety and productivity.

For us, that is “Sensor Intelligence.”

## WORLDWIDE PRESENCE:

Contacts and other locations –[www.sick.com](http://www.sick.com)