



# MLSE-0600A2NP0

MLS

MAGNETIC SENSORS

**SICK**  
Sensor Intelligence.



### Ordering information

Type	Part no.
MLSE-0600A2NP0	1090691

Other models and accessories → [www.sick.com/MLS](http://www.sick.com/MLS)



### Detailed technical data

#### Features

<b>Detection range typ.</b>	600 mm
<b>Operating height</b>	10 mm ... 70 mm
<b>Electrical wiring</b>	DC 4-wire
<b>Enclosure rating</b>	IP65, IP67, IP68 <sup>1)</sup>

<sup>1)</sup> According to EN 60529.

#### Mechanics/electronics

<b>Supply voltage</b>	9 V DC ... 30 V DC
<b>Terminal resistor</b>	No internal terminator
<b>Protection class</b>	III
<b>Power consumption</b>	600 mW
<b>Resolution, typ.</b>	1 mm
<b>Repeat accuracy, typ.</b>	1 mm
<b>Update rate</b>	100 Hz
<b>Teach-in</b>	✓
<b>Reverse polarity protection</b>	Yes
<b>Short-circuit protection</b>	Yes
<b>Ambient operating temperature</b>	-20 °C ... +70 °C
<b>Shock and vibration resistance</b>	30 g, 11 ms/10 Hz ... 55 Hz, 1 mm
<b>EMC</b>	EN 61000-6-2, EN 61000-6-4
<b>Connection type</b>	Cable with M8 male connector, 4-pin, 0.3 m <sup>1)</sup>
<b>Connection type Detail</b>	
Conductor cross section	0.08 mm <sup>2</sup>
<b>Material</b>	
Housing	Metal, Aluminum, plastic
Cable	PUR
<b>UL File No.</b>	NRKH.E181493 & NRKH7.E181493

<sup>1)</sup> Do not bend below 0 °C.

### Safety-related parameters

<b>MTTF<sub>D</sub></b>	94 years
<b>DC<sub>avg</sub></b>	0 %
<b>T<sub>M</sub> (mission time)</b>	20 years

### Communication interface

<b>Communication interface</b>	CANopen
--------------------------------	---------

### Diagnosis

<b>Orientation</b>	
Number of axis	3
Roll Euler angle measuring range	± 180°
Pitch Euler angle measuring range	± 90°
Yaw Euler angle measuring range	± 180°
Resolution	0.02°
Roll repeatability	± 1°
Pitch repeatability	± 1°
Yaw repeatability	± 1° <sup>1)</sup>
Maximum rotation rate	2,000 °/s
Quaternion w measuring range	0 ... + 1
Quaternion x measuring range	-1 ... 1
Quaternion y measuring range	-1 ... 1
Quaternion z measuring range	-1 ... 1
Update rate	100 Hz
Limit frequency	100 Hz
Initialization time	640 ms
Sampling rate	200 Hz <sup>2)</sup>
Acceleration measuring range	± 16 g <sup>2)</sup>
Rotation rate measuring range	± 2,000 °/s <sup>2)</sup>

<sup>1)</sup> Not long-term stable.

<sup>2)</sup> Raw data.

### Classifications

<b>ECLASS 5.0</b>	27270104
<b>ECLASS 5.1.4</b>	27270104
<b>ECLASS 6.0</b>	27270104
<b>ECLASS 6.2</b>	27270104
<b>ECLASS 7.0</b>	27270104
<b>ECLASS 8.0</b>	27270104
<b>ECLASS 8.1</b>	27270104
<b>ECLASS 9.0</b>	27270104
<b>ECLASS 10.0</b>	27270104
<b>ECLASS 11.0</b>	27270104
<b>ECLASS 12.0</b>	27274301

<b>ETIM 5.0</b>	EC002544
<b>ETIM 6.0</b>	EC002544
<b>ETIM 7.0</b>	EC002544
<b>ETIM 8.0</b>	EC002544
<b>UNSPSC 16.0901</b>	39122230

### Connection diagram

Cd-396

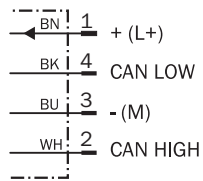

### Dimensional drawing (Dimensions in mm (inch))

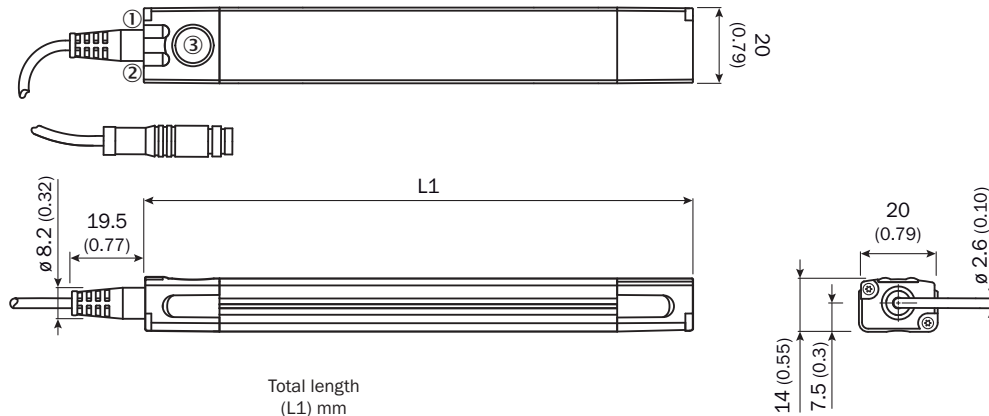

Total length (L1) mm

<b>MLSE-0200</b>	217
<b>MLSE-0300</b>	325
<b>MLSE-0400</b>	397
<b>MLSE-0500</b>	505
<b>MLSE-0600</b>	613

- ① Function signal indicator 1
- ② Function signal indicator 2
- ③ Teach-Pad

## Recommended accessories

Other models and accessories → [www.sick.com/MLS](http://www.sick.com/MLS)

	Brief description	Type	Part no.
<b>Bus adapter</b>			
	CAN-USB Adapter to connect MLS with a PC	AKA-NXL1BXB12KX	6067651
<b>Magnets</b>			
	Magnetic tape, North is top side, adhesive, width 25 mm, length 50 m	MAGNETIC TAPE	5337613
	Magnetic tape, South is top side, adhesive, width 25 mm, length 50 m	MAGNETIC TAPE	5337614
	Magnetic tape, north pole on top, self-adhesive, width = 25mm, external length = 524 mm, internal length = 511 mm, radius = 1000 mm, 30° section	Magnetic tape, curved	5344198
	Positioning device for magnetic markers (5337613, 5337614) for MLS	TEMPLATE	4097520
<b>Mounting brackets and plates</b>			
	Bracket for low mounting, Stainless steel V2A (bracket/mounting screw), Brass (fixing screw)	BEF-WNLO1MPA	2065973
	Bracket for lateral mounting, Stainless steel V2A (bracket/mounting screw), Brass (fixing screw)	BEF-WNZO1MPA	2065577
	<ul style="list-style-type: none"> <li><b>Connection type head A:</b> Female connector, M8, 4-pin, straight, A-coded</li> <li><b>Connection type head B:</b> Flying leads</li> <li><b>Signal type:</b> Sensor/actuator cable</li> <li><b>Cable:</b> 2 m, 4-wire, PUR, halogen-free</li> <li><b>Description:</b> Sensor/actuator cable, unshielded</li> <li><b>Application:</b> Zones with oils and lubricants, Drag chain operation, Robot</li> </ul>	YF8U14-020UA3XLEAX	2094791
	<ul style="list-style-type: none"> <li><b>Connection type head A:</b> Female connector, M8, 4-pin, straight, A-coded</li> <li><b>Connection type head B:</b> Flying leads</li> <li><b>Signal type:</b> Sensor/actuator cable</li> <li><b>Cable:</b> 5 m, 4-wire, PUR, halogen-free</li> <li><b>Description:</b> Sensor/actuator cable, unshielded</li> <li><b>Application:</b> Zones with oils and lubricants, Drag chain operation, Robot</li> </ul>	YF8U14-050UA3XLEAX	2094792
	<ul style="list-style-type: none"> <li><b>Connection type head A:</b> Female connector, M8, 4-pin, angled, A-coded</li> <li><b>Connection type head B:</b> Flying leads</li> <li><b>Signal type:</b> Sensor/actuator cable</li> <li><b>Cable:</b> 2 m, 4-wire, PUR, halogen-free</li> <li><b>Description:</b> Sensor/actuator cable, unshielded</li> <li><b>Application:</b> Zones with oils and lubricants, Drag chain operation, Robot</li> </ul>	YG8U14-020UA3XLEAX	2095589
	<ul style="list-style-type: none"> <li><b>Connection type head A:</b> Female connector, M8, 4-pin, angled, A-coded</li> <li><b>Connection type head B:</b> Flying leads</li> <li><b>Signal type:</b> Sensor/actuator cable</li> <li><b>Cable:</b> 5 m, 4-wire, PUR, halogen-free</li> <li><b>Description:</b> Sensor/actuator cable, unshielded</li> <li><b>Application:</b> Zones with oils and lubricants, Drag chain operation, Robot</li> </ul>	YG8U14-050UA3XLEAX	2095590
	<ul style="list-style-type: none"> <li><b>Description:</b> Y-cable to connect MLS to a CAN-USB Adapter and a power supply (Input: 100-240V, 1.0A max., 50-60Hz; Output: +24V DC; Connector: 2.1x5.5x11-S)</li> </ul>	YF8U14-011VA3FYDN2	2098412

## SICK AT A GLANCE

SICK is one of the leading manufacturers of intelligent sensors and sensor solutions for industrial applications. A unique range of products and services creates the perfect basis for controlling processes securely and efficiently, protecting individuals from accidents and preventing damage to the environment.

We have extensive experience in a wide range of industries and understand their processes and requirements. With intelligent sensors, we can deliver exactly what our customers need. In application centers in Europe, Asia and North America, system solutions are tested and optimized in accordance with customer specifications. All this makes us a reliable supplier and development partner.

Comprehensive services complete our offering: SICK LifeTime Services provide support throughout the machine life cycle and ensure safety and productivity.

For us, that is “Sensor Intelligence.”

## WORLDWIDE PRESENCE:

Contacts and other locations –[www.sick.com](http://www.sick.com)