



MPS-128TLTQ0

MPS-T

POSITION SENSORS

SICK
Sensor Intelligence.



Ordering information

Type	Part no.
MPS-128TLTQ0	1062518

Other models and accessories → www.sick.com/MPS-T



Detailed technical data

Features

Cylinder type	T-slot
Cylinder types with adapter	Round body cylinder Profile cylinders and tie-rod cylinders Dovetail groove cylinder SMC rail CDQ2 SMC rail ECDQ2 SMC cylinders with C-slot
Measuring range	128 mm ¹⁾
Housing length	141 mm
Output function	IO-Link
Electrical wiring	DC 4-wire
Enclosure rating	IP67 ²⁾
Adjustment	
	Teach-in control panel
	IO-Link
	Resetting the measuring range to factory settings
	Key lock
	Teaching in the measuring range
	Resetting the measuring range
IO-Link functions	Standard functions

¹⁾ ± 1 mm.

²⁾ According to EN 60529.

Mechanics/electronics

Supply voltage	15 V DC ... 30 V DC
Power consumption	25 mA, without load

¹⁾ FSR: Full Scale Range; max. measuring range.

²⁾ At 25 ° C, linearity error (maximum deviation) depending on response curve and minimal deviation function.

³⁾ At 25 ° C, repeatability magnet movement in one direction.

⁴⁾ Only in standard mode, not in IO-Link mode.

⁵⁾ The analog measured value can deviate for up to 100 ms under transient conditions.

Protection class	III
Time delay before availability	1.5 s
Required magnetic field sensitivity, typ.	4 mT ... 30 mT
Resolution, typ.	0.03 % FSR (max. ≥ 0.05 mm) ¹⁾
Linearity error, typ.	0.3 mm ²⁾
Repeat accuracy, typ.	0.06 % FSR (≥ 0.1 mm) ³⁾
Sampling rate, typ.	1 ms ⁴⁾
Reverse polarity protection	Yes
Short-circuit protection	Yes
Status indicator LED	Yes
Teach-in	Yes
Ambient operating temperature	-20 °C ... +70 °C
Shock and vibration resistance	30 g, 11 ms / 10 ... 55 Hz, 1 mm
EMC	According to EN 60947-5-7 ⁵⁾
Connection type	Cable with M12 male connector, 4-pin, 0.3 m
Connection type Detail	
Deep-freeze property	Do not bend below 0 °C
Conductor cross section	0.08 mm ²
Cable diameter	Ø 2.6 mm
Bending radius	With fixed installation > 5 x cable diameter For flexible use > 10 x cable diameter
Cable outlet	Axial
Material	
Housing	Plastic
Cable	PUR
UL File No.	NRKH.E181493 & NRKH7.E181493

¹⁾ FSR: Full Scale Range; max. measuring range.

²⁾ At 25 °C, linearity error (maximum deviation) depending on response curve and minimal deviation function.

³⁾ At 25 °C, repeatability magnet movement in one direction.

⁴⁾ Only in standard mode, not in IO-Link mode.

⁵⁾ The analog measured value can deviate for up to 100 ms under transient conditions.

Safety-related parameters

MTTF_D	308 years
DC_{avg}	0 %
T_M (mission time)	20 years

Communication interface

Communication interface	IO-Link V1.1
Communication Interface detail	COM2
Cycle time	2.3 ms
Process data length	16 Bit
Process data structure	Bit 0 ... 15 = position (in 1 mm/128)

Classifications

ECLASS 5.0	27270104
ECLASS 5.1.4	27270104
ECLASS 6.0	27270104
ECLASS 6.2	27270104
ECLASS 7.0	27270104
ECLASS 8.0	27270104
ECLASS 8.1	27270104
ECLASS 9.0	27270104
ECLASS 10.0	27270104
ECLASS 11.0	27270104
ECLASS 12.0	27274301
ETIM 5.0	EC002544
ETIM 6.0	EC002544
ETIM 7.0	EC002544
ETIM 8.0	EC002544
UNSPSC 16.0901	39122230

Installation note

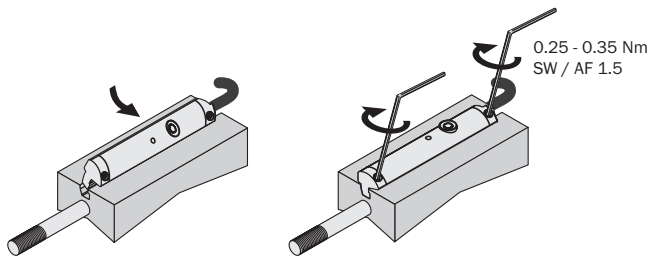

Connection diagram

Cd-179

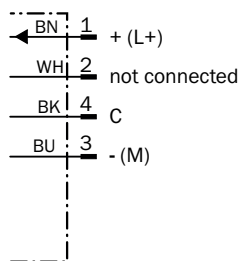

Dimensional drawing (Dimensions in mm (inch))

Cable with connector M12, with knurled nuts, Teach-in

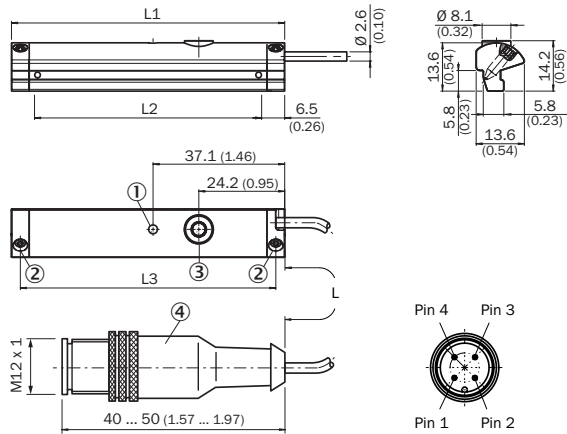

	Total length (L1) mm	Measuring range (L2) mm	Distance mounting screws (L3) mm
MPS-32	45	32	40
MPS-64	77	64	72
MPS-96	109	96	104
MPS-128	141	128	136
MPS-160	173	160	168
MPS-192	205	192	200
MPS-224	237	224	232
MPS-256	269	256	264

- ① Function indicator
- ② Fixing screw SW 1.5
- ③ Teach-in button
- ④ Connection





Part no.	Type	L	Number of cores
1097751	MPS-032TSTQDS06	600 mm	4
1062506	MPS-032TLTQO	300 mm	4
1062507	MPS-064TLTQO	300 mm	4
1062508	MPS-096TLTQO	300 mm	4
1062518	MPS-128TLTQO	300 mm	4
1062521	MPS-160TLTQO	300 mm	4
1062519	MPS-192TLTQO	300 mm	4
1062522	MPS-224TLTQO	300 mm	4
1062520	MPS-256TLTQO	300 mm	4
1096343	MPS-128TSTQD	250 mm	3

Recommended accessories

Other models and accessories → www.sick.com/MPS-T

	Brief description	Type	Part no.
Brackets for cylinder sensors			
	Mounting bracket for cylinder with dovetail slot, Aluminum, without mounting hardware	BEF-KHZ-ST1	2022703
	Mounting bracket for integrated profile cylinder/tie-rod cylinder, zinc diecast, mounting hardware included	BEF-KHZ-PT1	2022702
	1 piece, Mounting bracket on round body cylinder with piston diameter of 12 mm, ambient temperature min 0 °C max 50 °C, plastic, Aluminum	BEF-KHZ-RT-12	2077681
	1 piece, Mounting bracket on round body cylinder with piston diameter of 16 mm, ambient temperature min 0 °C max 50 °C, plastic, Aluminum	BEF-KHZ-RT-16	2077680

	Brief description	Type	Part no.
	1 piece, Mounting bracket on round body cylinder with piston diameter of 20 mm, ambient temperature min 0 °C max 50 °C, plastic, Aluminum	BEF-KHZ-RT-20	2077679
	1 piece, Mounting bracket on round body cylinder with piston diameter of 25 mm, ambient temperature min 0 °C max 50 °C, plastic, Aluminum	BEF-KHZ-RT-25	2077678
	1 piece, Mounting bracket on round body cylinder with piston diameter of 32 mm, ambient temperature min 0 °C max 50 °C, plastic, Aluminum	BEF-KHZ-RT-32	2077677
	1 piece, Mounting bracket on round body cylinder with piston diameter of 40 mm, ambient temperature min 0 °C max 50 °C, plastic, Aluminum	BEF-KHZ-RT-40	2077676
	1 piece, Mounting bracket on round body cylinder with piston diameter of 50 mm, ambient temperature min 0 °C max 50 °C, plastic, Aluminum	BEF-KHZ-RT-50	2077675
	1 piece, Mounting bracket on round body cylinder with piston diameter of 63 mm, ambient temperature min 0 °C max 50 °C, plastic, Aluminum	BEF-KHZ-RT-63	2077674
	1 piece, Mounting bracket on round body cylinder with piston diameter of 8 mm ... 130 mm, ambient temperature min -30 °C max 80 °C, stainless steel, Zinc cast	BEF-KHZ-RT1-130	2077684
	1 piece, Mounting bracket on round body cylinder with piston diameter of 8 mm ... 25 mm, ambient temperature min -30 °C max 80 °C, stainless steel, Zinc cast	BEF-KHZ-RT1-25	2077682
	1 piece, Mounting bracket on round body cylinder with piston diameter of 8 mm ... 63 mm, ambient temperature min -30 °C max 80 °C, stainless steel, Zinc cast	BEF-KHZ-RT1-63	2077683
	Mounting bracket for mounting on SMC rails CDQ2 (T-slot), Aluminum, without mounting hardware	BEF-KHZ-TT2	2046440
	Mounting bracket for mounting on SMC rails ECDQ2 (T-slot), Aluminum, without mounting hardware	BEF-KHZ-TT1	2046439
Other mounting accessories			
	Cable clips T-slot, 10 pcs./bag	CABLE CLIPS	2059322
	10 pieces, Label Holder, 2.5 mm to 3.5 mm, 10 pcs., TPU	LABEL HOLDER	2086019
Others			
	<ul style="list-style-type: none"> • Connection type head A: Female connector, M12, 4-pin, straight, A-coded • Description: Unshielded, Head A: female connector, M12, 4-pin, straight, unshielded, for power supply, for cable diameter 4 mm ... 6 mm Head B: - • Connection systems: Screw-type terminals • Permitted cross-section: ≤ 0.75 mm² 	DOS-1204-G	6007302
	<ul style="list-style-type: none"> • Connection type head A: Female connector, M12, 4-pin, angled, A-coded • Description: Unshielded, Head A: female connector, M12, 4-pin, angled, unshielded, for power supply, for cable diameter 3 mm ... 6.5 mm Head B: - • Connection systems: Screw-type terminals • Permitted cross-section: ≤ 0.75 mm² 	DOS-1204-W	6007303
	<ul style="list-style-type: none"> • Connection type head A: Male connector, M12, 4-pin, straight, A-coded • Description: Unshielded • Connection systems: Screw-type terminals • Permitted cross-section: ≤ 0.75 mm² 	STE-1204-G	6009932
	<ul style="list-style-type: none"> • Connection type head A: Male connector, M12, 4-pin, angled, A-coded • Description: Unshielded • Connection systems: Screw-type terminals • Permitted cross-section: ≤ 0.75 mm² 	STE-1204-W	6022084

	Brief description	Type	Part no.
	<ul style="list-style-type: none"> • Connection type head A: Female connector, M12, 4-pin, straight, A-coded • Connection type head B: Flying leads • Signal type: Sensor/actuator cable • Cable: 2 m, 4-wire, PUR, halogen-free • Description: Sensor/actuator cable, unshielded • Application: Zones with oils and lubricants, Drag chain operation, Robot 	YF2A14-020UB3XLEAX	2095607
	<ul style="list-style-type: none"> • Connection type head A: Female connector, M12, 4-pin, straight, A-coded • Connection type head B: Flying leads • Signal type: Sensor/actuator cable • Cable: 5 m, 4-wire, PUR, halogen-free • Description: Sensor/actuator cable, unshielded • Application: Zones with oils and lubricants, Drag chain operation, Robot 	YF2A14-050UB3XLEAX	2095608
	<ul style="list-style-type: none"> • Connection type head A: Female connector, M12, 4-pin, angled, A-coded • Connection type head B: Flying leads • Signal type: Sensor/actuator cable • Cable: 2 m, 4-wire, PUR, halogen-free • Description: Sensor/actuator cable, unshielded • Application: Zones with oils and lubricants, Drag chain operation, Robot 	YG2A14-020UB3XLEAX	2095766
	<ul style="list-style-type: none"> • Connection type head A: Female connector, M12, 4-pin, angled, A-coded • Connection type head B: Flying leads • Signal type: Sensor/actuator cable • Cable: 5 m, 4-wire, PUR, halogen-free • Description: Sensor/actuator cable, unshielded • Application: Zones with oils and lubricants, Drag chain operation, Robot 	YG2A14-050UB3XLEAX	2095767

Recommended services

Additional services → www.sick.com/MPS-T

	Type	Part no.
Function Block Factory		
<ul style="list-style-type: none"> • Description: The Function Block Factory supports common programmable logic controllers (PLCs) from various manufacturers, such as Siemens, Beckhoff, Rockwell Automation and B&R. More information on the FBF can be found <a _blank"="" href="https://fbf.cloud.sick.com target=">here. • Note: You can configure your function block at <a _blank"="" href="https://fbf.cloud.sick.com target=">Function Block Factory. As a login please use your SICK ID. 	Function Block Factory	On request

SICK AT A GLANCE

SICK is one of the leading manufacturers of intelligent sensors and sensor solutions for industrial applications. A unique range of products and services creates the perfect basis for controlling processes securely and efficiently, protecting individuals from accidents and preventing damage to the environment.

We have extensive experience in a wide range of industries and understand their processes and requirements. With intelligent sensors, we can deliver exactly what our customers need. In application centers in Europe, Asia and North America, system solutions are tested and optimized in accordance with customer specifications. All this makes us a reliable supplier and development partner.

Comprehensive services complete our offering: SICK LifeTime Services provide support throughout the machine life cycle and ensure safety and productivity.

For us, that is “Sensor Intelligence.”

WORLDWIDE PRESENCE:

Contacts and other locations –www.sick.com