



MPS-224TSTU0

MPS-T

POSITION SENSORS

SICK
Sensor Intelligence.



Ordering information

| Type | Part no. |
|--------------|----------|
| MPS-224TSTU0 | 1050741 |

Other models and accessories → www.sick.com/MPS-T



Detailed technical data

Features

| | |
|------------------------------------|--|
| Cylinder type | T-slot |
| Cylinder types with adapter | Round body cylinder Profile cylinders and tie-rod cylinders Dovetail groove cylinder SMC rail CDQ2 SMC rail ECDQ2 SMC cylinders with C-slot |
| Measuring range | 224 mm ¹⁾ |
| Housing length | 237 mm |
| Output function | Analog |
| Electrical wiring | DC 4-wire |
| Analog output (voltage) | 0 V ... 10 V ²⁾ |
| Analog output (current) | 4 mA ... 20 mA ²⁾ |
| Enclosure rating | IP67 ³⁾ |
| Adjustment | |
| Teach-in control panel | Teaching in analog outputs Resetting the measuring range to factory settings |

¹⁾ ± 1 mm.

²⁾ The sensor only activates the wired output.

³⁾ According to EN 60529.

Mechanics/electronics

| | |
|--------------------------|---------------------|
| Supply voltage | 15 V DC ... 30 V DC |
| Power consumption | 22 mA, without load |

¹⁾ Voltage output.

²⁾ FSR: Full Scale Range; max. measuring range.

³⁾ At 25 ° C, linearity error (maximum deviation) depending on response curve and minimal deviation function.

⁴⁾ At 25 ° C, repeatability magnet movement in one direction.

⁵⁾ Only in standard mode, not in IO-Link mode.

⁶⁾ The analog measured value can deviate for up to 100 ms under transient conditions.

| | |
|--|--|
| Max. load resistance | ≤ 500 Ω Power Output, at 24 V |
| Min. load resistance | ≥ 2 kΩ ¹⁾ |
| Protection class | III |
| Time delay before availability | 1.5 s |
| Required magnetic field sensitivity, typ. | 4 mT ... 30 mT |
| Resolution, typ. | 0.03 % FSR (max. ≥ 0.05 mm) ²⁾ |
| Linearity error, typ. | 0.3 mm ³⁾ |
| Repeat accuracy, typ. | 0.06 % FSR (≥ 0.1 mm) ⁴⁾ |
| Sampling rate, typ. | 1 ms ⁵⁾ |
| Reverse polarity protection | Yes |
| Short-circuit protection | Yes |
| Status indicator LED | Yes |
| Teach-in | Yes |
| Ambient operating temperature | -20 °C ... +70 °C |
| Shock and vibration resistance | 30 g, 11 ms / 10 ... 55 Hz, 1 mm |
| EMC | According to EN 60947-5-7 ⁶⁾ |
| Connection type | Cable, 4-wire, 2 m |
| Connection type Detail | |
| Deep-freeze property | Do not bend below 0 °C |
| Conductor cross section | 0.08 mm ² |
| Cable diameter | Ø 2.6 mm |
| Bending radius | With fixed installation > 5 x cable diameter For flexible use > 10 x cable diameter |
| Cable outlet | Axial |
| Material | |
| Housing | Plastic |
| Cable | PUR |
| UL File No. | NRKH.E181493 & NRKH7.E181493 |

¹⁾ Voltage output.

²⁾ FSR: Full Scale Range; max. measuring range.

³⁾ At 25 °C, linearity error (maximum deviation) depending on response curve and minimal deviation function.

⁴⁾ At 25 °C, repeatability magnet movement in one direction.

⁵⁾ Only in standard mode, not in IO-Link mode.

⁶⁾ The analog measured value can deviate for up to 100 ms under transient conditions.

Safety-related parameters

| | |
|-------------------------------------|-----------|
| MTTF_D | 198 years |
| DC_{avg} | 0 % |
| T_M (mission time) | 20 years |

Classifications

| | |
|---------------------|----------|
| ECLASS 5.0 | 27270104 |
| ECLASS 5.1.4 | 27270104 |
| ECLASS 6.0 | 27270104 |

| | |
|-----------------------|----------|
| ECLASS 6.2 | 27270104 |
| ECLASS 7.0 | 27270104 |
| ECLASS 8.0 | 27270104 |
| ECLASS 8.1 | 27270104 |
| ECLASS 9.0 | 27270104 |
| ECLASS 10.0 | 27270104 |
| ECLASS 11.0 | 27270104 |
| ECLASS 12.0 | 27274301 |
| ETIM 5.0 | EC002544 |
| ETIM 6.0 | EC002544 |
| ETIM 7.0 | EC002544 |
| ETIM 8.0 | EC002544 |
| UNSPSC 16.0901 | 39122230 |

Installation note

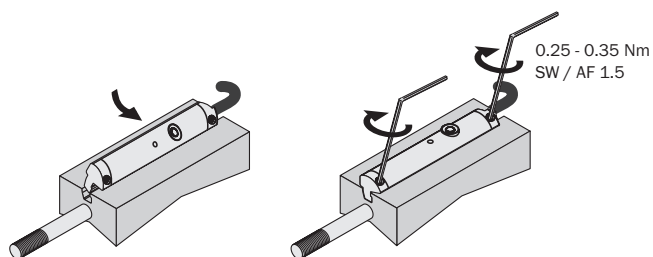

Connection type



Connection diagram

Cd-359

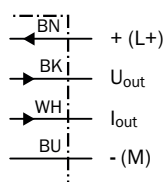

Dimensional drawing (Dimensions in mm (inch))

Cable, Teach-in

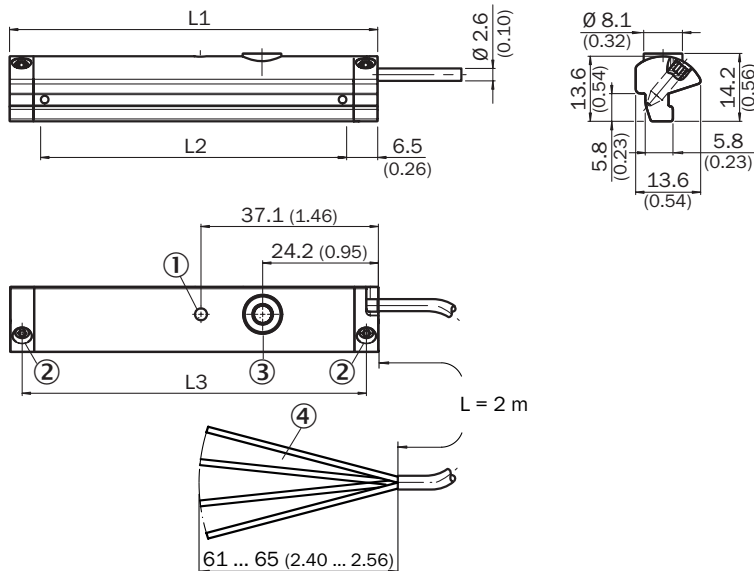



| | Total length (L1) mm | Measuring range (L2) mm | Distance mounting screws (L3) mm |
|----------------|----------------------|-------------------------|----------------------------------|
| MPS-32 | 45 | 32 | 40 |
| MPS-64 | 77 | 64 | 72 |
| MPS-96 | 109 | 96 | 104 |
| MPS-128 | 141 | 128 | 136 |
| MPS-160 | 173 | 160 | 168 |
| MPS-192 | 205 | 192 | 200 |
| MPS-224 | 237 | 224 | 232 |
| MPS-256 | 269 | 256 | 264 |

- ① Function indicator
- ② Fixing screw SW 1.5
- ③ Teach-in button
- ④ Connection

Recommended accessories

Other models and accessories → www.sick.com/MPS-T

| | Brief description | Type | Part no. |
|--------------------------------------|---|---------------|----------|
| Brackets for cylinder sensors | | | |
| | Mounting bracket for cylinder with dovetail slot, Aluminum, without mounting hardware | BEF-KHZ-ST1 | 2022703 |
| | Mounting bracket for integrated profile cylinder/tie-rod cylinder, zinc diecast, mounting hardware included | BEF-KHZ-PT1 | 2022702 |
| | 1 piece, Mounting bracket on round body cylinder with piston diameter of 12 mm, ambient temperature min 0 °C max 50 °C, plastic, Aluminum | BEF-KHZ-RT-12 | 2077681 |
| | 1 piece, Mounting bracket on round body cylinder with piston diameter of 16 mm, ambient temperature min 0 °C max 50 °C, plastic, Aluminum | BEF-KHZ-RT-16 | 2077680 |
| | 1 piece, Mounting bracket on round body cylinder with piston diameter of 20 mm, ambient temperature min 0 °C max 50 °C, plastic, Aluminum | BEF-KHZ-RT-20 | 2077679 |
| | 1 piece, Mounting bracket on round body cylinder with piston diameter of 25 mm, ambient temperature min 0 °C max 50 °C, plastic, Aluminum | BEF-KHZ-RT-25 | 2077678 |
| | 1 piece, Mounting bracket on round body cylinder with piston diameter of 32 mm, ambient temperature min 0 °C max 50 °C, plastic, Aluminum | BEF-KHZ-RT-32 | 2077677 |
| | 1 piece, Mounting bracket on round body cylinder with piston diameter of 40 mm, ambient temperature min 0 °C max 50 °C, plastic, Aluminum | BEF-KHZ-RT-40 | 2077676 |

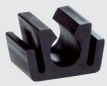
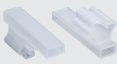
| | Brief description | Type | Part no. |
|---|--|-----------------|----------|
|  | 1 piece, Mounting bracket on round body cylinder with piston diameter of 50 mm, ambient temperature min 0 °C max 50 °C, plastic, Aluminum | BEF-KHZ-RT-50 | 2077675 |
| | 1 piece, Mounting bracket on round body cylinder with piston diameter of 63 mm, ambient temperature min 0 °C max 50 °C, plastic, Aluminum | BEF-KHZ-RT-63 | 2077674 |
| | 1 piece, Mounting bracket on round body cylinder with piston diameter of 8 mm ... 130 mm, ambient temperature min -30 °C max 80 °C, stainless steel, Zinc cast | BEF-KHZ-RT1-130 | 2077684 |
| | 1 piece, Mounting bracket on round body cylinder with piston diameter of 8 mm ... 25 mm, ambient temperature min -30 °C max 80 °C, stainless steel, Zinc cast | BEF-KHZ-RT1-25 | 2077682 |
| | 1 piece, Mounting bracket on round body cylinder with piston diameter of 8 mm ... 63 mm, ambient temperature min -30 °C max 80 °C, stainless steel, Zinc cast | BEF-KHZ-RT1-63 | 2077683 |
|  | Mounting bracket for mounting on SMC rails CDQ2 (T-slot), Aluminum, without mounting hardware | BEF-KHZ-TT2 | 2046440 |
|  | Mounting bracket for mounting on SMC rails ECDQ2 (T-slot), Aluminum, without mounting hardware | BEF-KHZ-TT1 | 2046439 |
| Other mounting accessories | | | |
|  | Cable clips T-slot, 10 pcs./bag | CABLE CLIPS | 2059322 |
|  | 10 pieces, Label Holder, 2.5 mm to 3.5 mm, 10 pcs., TPU | LABEL HOLDER | 2086019 |

SICK AT A GLANCE

SICK is one of the leading manufacturers of intelligent sensors and sensor solutions for industrial applications. A unique range of products and services creates the perfect basis for controlling processes securely and efficiently, protecting individuals from accidents and preventing damage to the environment.

We have extensive experience in a wide range of industries and understand their processes and requirements. With intelligent sensors, we can deliver exactly what our customers need. In application centers in Europe, Asia and North America, system solutions are tested and optimized in accordance with customer specifications. All this makes us a reliable supplier and development partner.

Comprehensive services complete our offering: SICK LifeTime Services provide support throughout the machine life cycle and ensure safety and productivity.

For us, that is “Sensor Intelligence.”

WORLDWIDE PRESENCE:

Contacts and other locations –www.sick.com