



MZN-03VPS-KP0

MZN

SENSORS FOR IMI NORGREN SLOT

SICK
Sensor Intelligence.



Ordering information

| Type | Part no. |
|---------------|----------|
| MZN-03VPS-KPO | 1117577 |

Other models and accessories → www.sick.com/MZN



Detailed technical data

Features

| | |
|------------------------------------|---------------------|
| Cylinder type | IMI Norgren slot |
| Cylinder types with adapter | Round body cylinder |
| Housing length | 29,5 mm |
| Switching output | PNP |
| Switching frequency | 1,000 Hz |
| Output function | NO |
| Electrical wiring | DC 3-wire |
| Enclosure rating | IP67 ¹⁾ |

¹⁾ According to EN 60529.

Mechanics/electronics

| | |
|---|---|
| Supply voltage | 10 V DC ... 30 V DC |
| Power consumption | 10 mA, without load |
| Voltage drop | ≤ 2 V |
| Continuous current I_a | ≤ 100 mA |
| Protection class | III |
| Response sensitivity, typ. | 2.8 mT |
| Overrun distance, typ. | 9 mm |
| Hysteresis, typ. | 0.8 mT |
| Reproducibility | ≤ 0.1 mT ¹⁾ |
| Reverse polarity protection | Yes |
| Short-circuit protection | Yes |
| Status indicator LED | Yes |
| Ambient operating temperature | -40 °C ... +80 °C |
| Shock and vibration resistance | 30 g, 11 ms / 10 ... 55 Hz, 1 mm |
| EMC | According to EN 60947-5-2 |
| Connection type | Cable with connector M8, 3-pin, drag chain use, 0.3 m |

¹⁾ Supply voltage U_B and constant ambient temperature T_a.

| | |
|-------------------------------|--|
| Connection type Detail | |
| Cable diameter | Ø 2.9 mm |
| Bending radius | With fixed installation > 3 x cable diameter For flexible use > 10 x cable diameter |
| Torsion force | ± 270° / 10 cm |
| Torsion cycles | > 2,000,000 |
| Cable outlet | Axial |
| Material | |
| Housing | Plastic |
| Cable | TPU |
| Items supplied | 1 x mounting clip plugged in |
| UL File No. | NRKH.E181493 & NRKH7.E181493 |

¹⁾ Supply voltage U_B and constant ambient temperature T_a .

Safety-related parameters

| | |
|-------------------------------------|-------------|
| MTTF_D | 4,675 years |
| DC_{avg} | 0 % |
| T_M (mission time) | 20 years |

Classifications

| | |
|-----------------------|----------|
| ECLASS 5.0 | 27270104 |
| ECLASS 5.1.4 | 27270104 |
| ECLASS 6.0 | 27270104 |
| ECLASS 6.2 | 27270104 |
| ECLASS 7.0 | 27270104 |
| ECLASS 8.0 | 27270104 |
| ECLASS 8.1 | 27270104 |
| ECLASS 9.0 | 27270104 |
| ECLASS 10.0 | 27270104 |
| ECLASS 11.0 | 27270104 |
| ECLASS 12.0 | 27274301 |
| ETIM 5.0 | EC002544 |
| ETIM 6.0 | EC002544 |
| ETIM 7.0 | EC002544 |
| ETIM 8.0 | EC002544 |
| UNSPSC 16.0901 | 39122230 |

Installation note

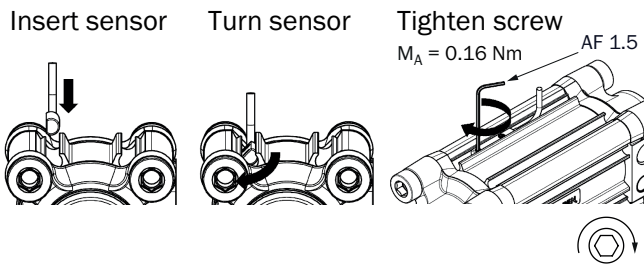

Connection diagram

Cd-002

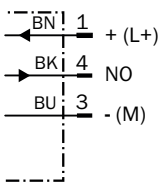

Dimensional drawing (Dimensions in mm (inch))

Cable with connector M8

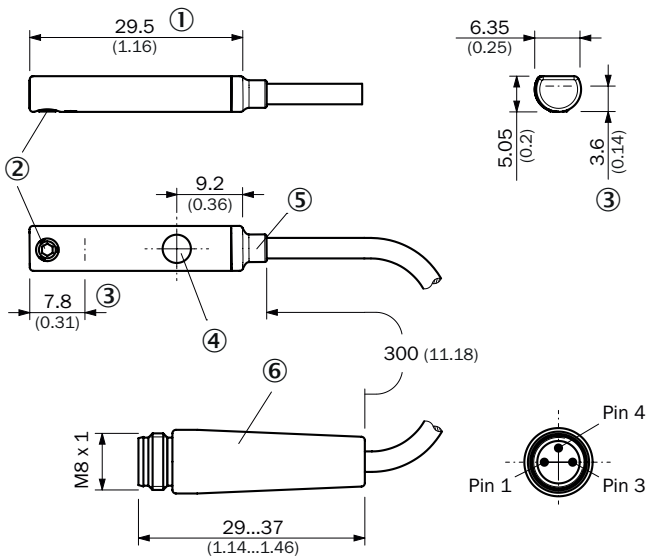





- ① Housing
- ② Fixing screw SW 1.5
- ③ Position sensor element
- ④ Display LED
- ⑤ Hotmelt sleeve
- ⑥ Connection

Recommended accessories

Other models and accessories → www.sick.com/MZN

| | Brief description | Type | Part no. |
|---|---|--------------------|----------|
| Brackets for cylinder sensors | | | |
|  | Mounting clip for round body cylinder, clamping range 9.2 mm to 10 mm, for piston rod diameter of 8 mm, plastic, mounting hardware included | BEF-S-R1-08 | 7902337 |
| | Mounting clip for round body cylinder, clamping range 10.9 mm to 12 mm, for piston rod diameter of 10 mm, plastic, mounting hardware included | BEF-S-R1-10 | 7901753 |
| | Mounting clip for round body cylinder, clamping range 12.9 mm to 41 mm, for piston rod diameter of 12 mm, plastic, mounting hardware included | BEF-S-R1-12 | 7901754 |
| | Mounting clip for round body cylinder, clamping range 16.9 mm to 18 mm, for piston rod diameter of 16 mm, plastic, mounting hardware included | BEF-S-R1-16 | 7901755 |
| | Mounting clip for round body cylinder, clamping range 21 mm to 22 mm, for piston rod diameter of 20 mm, plastic, mounting hardware included | BEF-S-R1-20 | 7901756 |
| | Mounting clip for round body cylinder, clamping range 26.1 mm to 27.2 mm, for piston rod diameter of 25 mm, plastic, mounting hardware included | BEF-S-R1-25 | 7901757 |
| | Mounting clip for round body cylinder, clamping range 33 mm to 35 mm, for piston rod diameter of 32 mm, plastic, mounting hardware included | BEF-S-R1-32 | 7901758 |
| | Mounting clip for round body cylinder, clamping range 41.4 mm to 42.5 mm, for piston rod diameter of 40 mm, plastic, mounting hardware included | BEF-S-R1-40 | 7901759 |
| | Mounting clip for round body cylinder, clamping range 52.5 mm to 54 mm, for piston rod diameter of 50 mm, plastic, mounting hardware included | BEF-S-R1-50 | 7901760 |
| | Mounting clip for round body cylinder, clamping range 66 mm to 67 mm, for piston rod diameter of 63 mm, plastic, mounting hardware included | BEF-S-R1-63 | 7901761 |
| Others | | | |
|  | <ul style="list-style-type: none"> • Connection type head A: Female connector, M8, 3-pin, angled, A-coded • Description: Unshielded • Connection systems: Solder connection • Permitted cross-section: ≤ 0.25 mm² | DOS-0803-W | 7902078 |
| | <ul style="list-style-type: none"> • Connection type head A: Female connector, M8, 3-pin, straight, A-coded • Description: Unshielded • Connection systems: Screw-type terminals • Permitted cross-section: 0.14 mm² ... 0.5 mm² | DOS-0803-G | 7902077 |
|  | <ul style="list-style-type: none"> • Connection type head A: Male connector, M8, 3-pin, straight, A-coded • Description: Unshielded • Connection systems: Screw-type terminals • Permitted cross-section: 0.14 mm² ... 0.5 mm² | STE-0803-G | 6037322 |
| | <ul style="list-style-type: none"> • Connection type head A: Female connector, M8, 3-pin, angled, A-coded • Connection type head B: Flying leads • Signal type: Sensor/actuator cable • Cable: 5 m, 3-wire, PVC • Description: Sensor/actuator cable, unshielded • Application: Zones with chemicals | YG8U13-050VA1XLEAX | 2096166 |
|  | <ul style="list-style-type: none"> • Connection type head A: Female connector, M8, 3-pin, angled, A-coded • Connection type head B: Flying leads • Signal type: Sensor/actuator cable • Cable: 2 m, 3-wire, PVC • Description: Sensor/actuator cable, unshielded • Application: Zones with chemicals | YG8U13-020VA1XLEAX | 2096165 |
| | <ul style="list-style-type: none"> • Connection type head A: Female connector, M8, 3-pin, angled, A-coded • Connection type head B: Flying leads • Signal type: Sensor/actuator cable • Cable: 2 m, 3-wire, PUR, halogen-free • Description: Sensor/actuator cable, unshielded • Application: Zones with oils and lubricants, Drag chain operation, Robot | YG8U13-020UA1XLEAX | 2094794 |

| | Brief description | Type | Part no. |
|---|---|--------------------|----------|
|  | <ul style="list-style-type: none"> • Connection type head A: Female connector, M8, 3-pin, straight, A-coded • Connection type head B: Flying leads • Signal type: Sensor/actuator cable • Cable: 5 m, 3-wire, PVC • Description: Sensor/actuator cable, unshielded • Application: Zones with chemicals | YF8U13-050VA1XLEAX | 2095884 |
|  | <ul style="list-style-type: none"> • Connection type head A: Female connector, M8, 3-pin, straight, A-coded • Connection type head B: Flying leads • Signal type: Sensor/actuator cable • Cable: 5 m, 3-wire, PUR, halogen-free • Description: Sensor/actuator cable, unshielded • Application: Zones with oils and lubricants, Drag chain operation, Robot | YF8U13-050UA1XLEAX | 2094788 |
|  | <ul style="list-style-type: none"> • Connection type head A: Female connector, M8, 3-pin, straight, A-coded • Connection type head B: Flying leads • Signal type: Sensor/actuator cable • Cable: 3 m, 3-wire, PUR, halogen-free • Description: Sensor/actuator cable, unshielded • Application: Zones with oils and lubricants, Drag chain operation, Robot | YF8U13-030UA1XLEAX | 2094787 |
|  | <ul style="list-style-type: none"> • Connection type head A: Female connector, M8, 3-pin, straight, A-coded • Connection type head B: Flying leads • Signal type: Sensor/actuator cable • Cable: 2 m, 3-wire, PVC • Description: Sensor/actuator cable, unshielded • Application: Zones with chemicals | YF8U13-020VA1XLEAX | 2095860 |
|  | <ul style="list-style-type: none"> • Connection type head A: Female connector, M8, 3-pin, straight, A-coded • Connection type head B: Flying leads • Signal type: Sensor/actuator cable • Cable: 2 m, 3-wire, PUR, halogen-free • Description: Sensor/actuator cable, unshielded • Application: Zones with oils and lubricants, Drag chain operation, Robot | YF8U13-020UA1XLEAX | 2094782 |

SICK AT A GLANCE

SICK is one of the leading manufacturers of intelligent sensors and sensor solutions for industrial applications. A unique range of products and services creates the perfect basis for controlling processes securely and efficiently, protecting individuals from accidents and preventing damage to the environment.

We have extensive experience in a wide range of industries and understand their processes and requirements. With intelligent sensors, we can deliver exactly what our customers need. In application centers in Europe, Asia and North America, system solutions are tested and optimized in accordance with customer specifications. All this makes us a reliable supplier and development partner.

Comprehensive services complete our offering: SICK LifeTime Services provide support throughout the machine life cycle and ensure safety and productivity.

For us, that is “Sensor Intelligence.”

WORLDWIDE PRESENCE:

Contacts and other locations –www.sick.com