



# MZT8-03VPS-KWX

MZT8 ATEX

SENSORS FOR T-SLOT CYLINDERS

**SICK**  
Sensor Intelligence.



### Ordering information

Type	Part no.
MZT8-03VPS-KWX	1073405

Other models and accessories → [www.sick.com/MZT8\\_ATEX](http://www.sick.com/MZT8_ATEX)



### Detailed technical data

#### Features

<b>Cylinder type</b>	T-slot
<b>Cylinder types with adapter</b>	Profile cylinder Tie rod cylinder Round body cylinder Dovetail groove cylinder SMC rail CDQ2 SMC rail ECDQ2
<b>Housing length</b>	24 mm
<b>Switching output</b>	PNP
<b>Switching frequency</b>	1,000 Hz
<b>Output function</b>	NO
<b>Electrical wiring</b>	DC 3-wire
<b>Enclosure rating</b>	IP67 <sup>1)</sup>

<sup>1)</sup> According to EN 60529 (IP 67 / IP 68).

#### Mechanics/electronics

<b>Supply voltage</b>	10 V DC ... 26 V DC <sup>1)</sup>
<b>Power consumption</b>	10 mA, without load
<b>Voltage drop</b>	≤ 2.2 V
<b>Continuous current I<sub>a</sub></b>	≤ 50 mA <sup>1)</sup>
<b>Ex area category</b>	3G, 3D
<b>Device labeling</b>	II 3G Ex nA IIC T4 Gc X, II 3D Ex tc IIIC T135 °C Dc X
<b>Response sensitivity, typ.</b>	2.8 mT
<b>Overrun distance, typ.</b>	3 mm

<sup>1)</sup> Depend on ambient temperature. For details see operating instructions under „performance data of the sensor“.

<sup>2)</sup> Supply voltage U<sub>B</sub> and constant ambient temperature T<sub>a</sub>.

<sup>3)</sup> PVC-cable without UL-Certificate.

<b>Hysteresis, typ.</b>	≤ 0.5 mT
<b>Reproducibility</b>	≤ 0.1 mT <sup>2)</sup>
<b>Reverse polarity protection</b>	Yes
<b>Short-circuit protection</b>	Yes
<b>Status indicator LED</b>	Yes
<b>Power-up pulse protection</b>	Yes
<b>Ambient operating temperature</b>	-20 °C ... +50 °C
<b>Shock and vibration resistance</b>	30 g, 11 ms / 10 ... 55 Hz, 1 mm
<b>EMC</b>	According to EN 60947-5-2
<b>Connection type</b>	Cable, 3-wire, 2 m
<b>Connection type Detail</b>	
Conductor cross section	0.14 mm <sup>2</sup>
Cable diameter	Ø 2.9 mm
Bending radius	With fixed installation > 10 x cable diameter For flexible use > 15 x cable diameter
Cable outlet	Axial
<b>Material</b>	
Housing	Plastic, PA12
Cable	PVC <sup>3)</sup>

<sup>1)</sup> Depend on ambient temperature. For details see operating instructions under „performance data of the sensor“.

<sup>2)</sup> Supply voltage  $U_B$  and constant ambient temperature  $T_a$ .

<sup>3)</sup> PVC-cable without UL-Certificate.

### Safety-related parameters

<b>MTTF<sub>D</sub></b>	2,289 years
<b>DC<sub>avg</sub></b>	0 %
<b>T<sub>M</sub> (mission time)</b>	20 years

### Classifications

<b>ECLASS 5.0</b>	27270104
<b>ECLASS 5.1.4</b>	27270104
<b>ECLASS 6.0</b>	27270104
<b>ECLASS 6.2</b>	27270104
<b>ECLASS 7.0</b>	27270104
<b>ECLASS 8.0</b>	27270104
<b>ECLASS 8.1</b>	27270104
<b>ECLASS 9.0</b>	27270104
<b>ECLASS 10.0</b>	27270104
<b>ECLASS 11.0</b>	27270104
<b>ECLASS 12.0</b>	27274301
<b>ETIM 5.0</b>	EC002544
<b>ETIM 6.0</b>	EC002544
<b>ETIM 7.0</b>	EC002544

# MZT8-03VPS-KWX | MZT8 ATEX

SENSORS FOR T-SLOT CYLINDERS

<b>ETIM 8.0</b>	EC002544
<b>UNSPSC 16.0901</b>	39122230

## Connection diagram

Cd-307

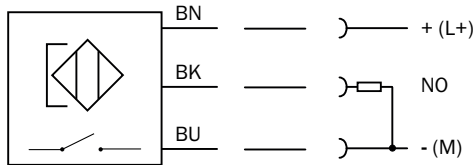

Cd-304

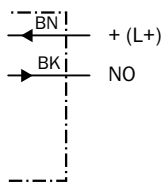

## Dimensional drawing (Dimensions in mm (inch))

Cable

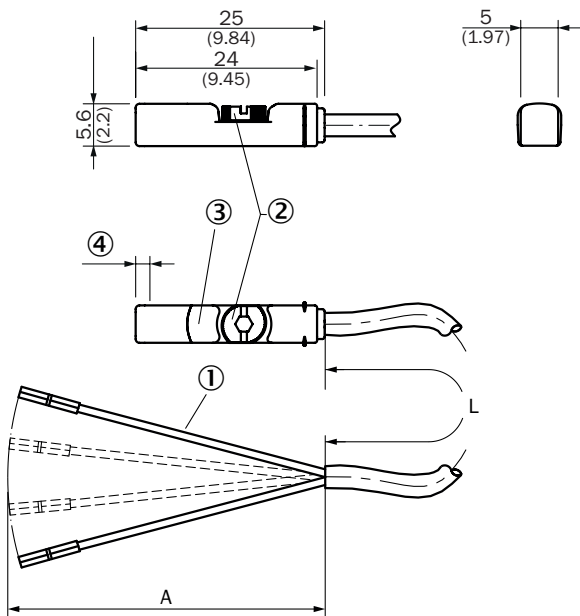







- ① Connection
- ② Fixing screw SW 2.0
- ③ Display LED
- ④ Sensor element position = short overrun distance (3 mm): 2.25 mm

Part no.	Type	L	A	Number of cores
1073405	MZT8-03VPS-KWX	2 m	42 mm	3

**Recommended accessories**

Other models and accessories → [www.sick.com/MZT8\\_ATEX](http://www.sick.com/MZT8_ATEX)

	<b>Brief description</b>	<b>Type</b>	<b>Part no.</b>
<b>Brackets for cylinder sensors</b>			
	Mounting bracket for cylinder with dovetail slot, Aluminum, without mounting hardware	BEF-KHZ-ST1	2022703
	Mounting bracket for integrated profile cylinder/tie-rod cylinder, zinc diecast, mounting hardware included	BEF-KHZ-PT1	2022702
	1 piece, Mounting bracket on round body cylinder with piston diameter of 12 mm, ambient temperature min 0 °C max 50 °C, plastic, Aluminum	BEF-KHZ-RT-12	2077681
	1 piece, Mounting bracket on round body cylinder with piston diameter of 16 mm, ambient temperature min 0 °C max 50 °C, plastic, Aluminum	BEF-KHZ-RT-16	2077680
	1 piece, Mounting bracket on round body cylinder with piston diameter of 20 mm, ambient temperature min 0 °C max 50 °C, plastic, Aluminum	BEF-KHZ-RT-20	2077679
	1 piece, Mounting bracket on round body cylinder with piston diameter of 25 mm, ambient temperature min 0 °C max 50 °C, plastic, Aluminum	BEF-KHZ-RT-25	2077678
	1 piece, Mounting bracket on round body cylinder with piston diameter of 32 mm, ambient temperature min 0 °C max 50 °C, plastic, Aluminum	BEF-KHZ-RT-32	2077677
	1 piece, Mounting bracket on round body cylinder with piston diameter of 40 mm, ambient temperature min 0 °C max 50 °C, plastic, Aluminum	BEF-KHZ-RT-40	2077676
	1 piece, Mounting bracket on round body cylinder with piston diameter of 50 mm, ambient temperature min 0 °C max 50 °C, plastic, Aluminum	BEF-KHZ-RT-50	2077675
	1 piece, Mounting bracket on round body cylinder with piston diameter of 63 mm, ambient temperature min 0 °C max 50 °C, plastic, Aluminum	BEF-KHZ-RT-63	2077674
	1 piece, Mounting bracket on round body cylinder with piston diameter of 8 mm ... 130 mm, ambient temperature min -30 °C max 80 °C, stainless steel, Zinc cast	BEF-KHZ-RT1-130	2077684
	1 piece, Mounting bracket on round body cylinder with piston diameter of 8 mm ... 25 mm, ambient temperature min -30 °C max 80 °C, stainless steel, Zinc cast	BEF-KHZ-RT1-25	2077682
	1 piece, Mounting bracket on round body cylinder with piston diameter of 8 mm ... 63 mm, ambient temperature min -30 °C max 80 °C, stainless steel, Zinc cast	BEF-KHZ-RT1-63	2077683
	Mounting bracket for mounting on SMC rails CDQ2 (T-slot), Aluminum, without mounting hardware	BEF-KHZ-TT2	2046440
	Mounting bracket for mounting on SMC rails ECDQ2 (T-slot), Aluminum, without mounting hardware	BEF-KHZ-TT1	2046439
<b>Device protection (mechanical)</b>			
	Protective adapter, die-cast zinc, mounting hardware included	BEF-SG-MRZT	2077201

## SICK AT A GLANCE

SICK is one of the leading manufacturers of intelligent sensors and sensor solutions for industrial applications. A unique range of products and services creates the perfect basis for controlling processes securely and efficiently, protecting individuals from accidents and preventing damage to the environment.

We have extensive experience in a wide range of industries and understand their processes and requirements. With intelligent sensors, we can deliver exactly what our customers need. In application centers in Europe, Asia and North America, system solutions are tested and optimized in accordance with customer specifications. All this makes us a reliable supplier and development partner.

Comprehensive services complete our offering: SICK LifeTime Services provide support throughout the machine life cycle and ensure safety and productivity.

For us, that is “Sensor Intelligence.”

## WORLDWIDE PRESENCE:

Contacts and other locations –[www.sick.com](http://www.sick.com)