



NCV50B-11EC0100100

SPEETEC 1D

NON-CONTACT MOTION SENSORS

SICK
Sensor Intelligence.

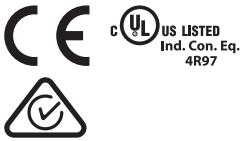

Illustration may differ

Ordering information

Type	Part no.
NCV50B-11EC0100100	1106857

Other models and accessories → www.sick.com/SPEETEC_1D



Detailed technical data

Features

Specialty	<p>SPEETEC closes the gap between tactile measuring wheel systems and complex laser Doppler sensors – and is suitable for almost all surfaces and objects thanks to the non-contact measurement that uses no measuring elements. This opens up new fields of application in motion monitoring.</p> <p>NCV50B is the preferred choice for retrofitting and use in end-customer applications where easy mounting is important. The NCV50B achieves a very high measurement accuracy with large mounting tolerances, which allows quick and easy mounting without a reference measurement or calibration.</p> <p>Non-contact measurement on moving objects without measuring elements.</p> <p>Class 1 laser</p>
------------------	--

Safety-related parameters

MTTFd: mean time to dangerous failure	33 years ¹⁾
--	------------------------

¹⁾ This product is a standard product and does not constitute a safety component as defined in the Machinery Directive. Calculation based on nominal load of components, average ambient temperature 40 °C, frequency of use 8760 h/a. All electronic failures are considered hazardous. For more information, see document no. 8015532.

System

Light source	2 continuous beam lasers ¹⁾
Wave length	850 nm
Laser class	1 (IEC 60825-1:2014)
Type of light	Invisible infrared light
Typ. measurement field size (distance)	2 mm x 3 mm (at 50 mm) 8 mm x 3 mm (at 45 mm) 8 mm x 3 mm (at 55 mm)
Laser power (per laser)	0.78 mW ²⁾

¹⁾ L10 ≥ 32,500 h (not temperature-dependent). The lasers are always on when the sensor is supplied with voltage. To increase the service life of the sensor, we recommend completely disconnecting the sensor from the voltage supply when it is not needed. No warranty claims relating to the reaching of the service life of the laser will be accepted.

²⁾ The device must not be operated if the screen is damaged or missing.

Performance

Nominal measuring distance	50 mm
Static mounting tolerance	Ca. ± 5 mm ¹⁾
Possible static measuring distance	30 ... 100 mm ²⁾
Direction of movement	1D, x-direction
Start/stop	Possible
Movement detection	Bidirectional
Measuring increment ($\mu\text{m}/\text{pulse}$)	100
Speed measuring range	> 0 m/s ... 10 m/s ³⁾
Permissible acceleration	≤ 30 m/s ²
Accuracy	
Measurement accuracy	0.1 % ⁴⁾
Repeatability	0.05 % ⁵⁾
Internal sampling rate	330 μs
Latency	2.9 ms

¹⁾ Mounting the device closer than the specified measuring distance will not affect the accuracy of the measurement for suitable materials. Operation outside of the tolerance is possible with restrictions.

²⁾ The possible measuring distance depends on the material and must be identified in each case for the material used in the application, see the "Permissible measuring distance" table. The static mounting tolerance is included in the range mentioned above and is not additionally available.

³⁾ No continuous operation < 0.05 m/s recommended.

⁴⁾ Error limit for systematic measurement deviation in accordance with DIN 1319-1:1995. Valid between 0.2 m/s ... 10 m/s. The achievable measurement accuracy depends on the accuracy of installation. See "Permissible deviations from nominal alignment".

⁵⁾ Maximum permissible measurement deviation in accordance with DIN 1319-1:1995 under constant conditions. Valid between 0.2 m/s ... 10 m/s, averaged over 0.25 m measuring length.

Electrical data

Supply voltage	12 V ... 30 V
Communication interface	HTL / Push pull
Output frequency	≤ 625 kHz
Connection type	Male connector, M12, 8-pin, A-coded ¹⁾
Parameterization and diagnostic interface with digital input and output	No
Power consumption	< 8 W
Load current	≤ 30 mA, per channel
Reverse polarity protection	✓
Protection class	III according to DIN EN 61140
Short-circuit resistant outputs	✓ ²⁾
Initialization time	Max. 3 s ³⁾

¹⁾ Observe the maximum length of cable: e.g. 20 m at a resolution of 4 μm and 1 m/s or 2 m at a resolution of 4 μm and 5 m/s: The frequency is calculated differentially with 4-fold evaluation as follows: Frequency = (speed/resolution) / 4; Example: (5.0 m/s / 4 μm) / 4 = 312.5 kHz; maximum frequency 625 kHz.

²⁾ Short-circuit to another channel, U_s or GND for max. 30 s.

³⁾ Digital output DO can have an undefined state during this time.

Mechanical data

Dimensions	140 mm x 95 mm x 32.5 mm (without plug)
-------------------	---

¹⁾ Exceeding these values will result in a higher systematic measurement error, see "Permissible deviations from nominal alignment".

Weight	400 g
Material	Housing: Aluminum
	Screen: PMMA
	Plug insert: PA66, copper-zinc alloy (CuZn)
Permissible angle	Permissible pitch angle: $\leq \pm 1.5^\circ$ ¹⁾
	Permissible yaw angle: $\leq \pm 1.5^\circ$ ¹⁾
	Permissible roll angle: $\leq \pm 10^\circ$ ¹⁾

¹⁾ Exceeding these values will result in a higher systematic measurement error, see "Permissible deviations from nominal alignment".

Ambient data

EMC	EN 61000-6-2, EN 61000-6-3
Enclosure rating	IP65 (EN 60529) ¹⁾
	IP67 (EN 60529) ¹⁾
Permissible relative humidity	70 % ²⁾
Temperature	Operating temperature range: 0 °C ... +45 °C ³⁾
	Storage temperature range: -32 °C ... +60 °C, without package
Resistance	Resistance to shocks: 30 g, 6 ms (EN 60068-2-27)
	Resistance to vibration: 20 g, 10 Hz ... 2,000 Hz (EN 60068-2-6)

¹⁾ For suitable mating connector and correct mounting of the mating connector.

²⁾ Condensation on laser modules and screen not permitted.

³⁾ If the permissible temperature range is exceeded, the sensor switches off the laser to protect it against damage. No signal is outputted in this case. The variant with parameterization and diagnostic functions offers the option of monitoring the internal temperature and therefore the reserves up until the point of switching off.

Classifications

ECLASS 5.0	27270790
ECLASS 5.1.4	27270790
ECLASS 6.0	27270790
ECLASS 6.2	27270790
ECLASS 7.0	27270790
ECLASS 8.0	27270790
ECLASS 8.1	27270790
ECLASS 9.0	27270790
ECLASS 10.0	27270790
ECLASS 11.0	27270790
ECLASS 12.0	27275201

Dimensional drawing (Dimensions in mm (inch))

Mounting side

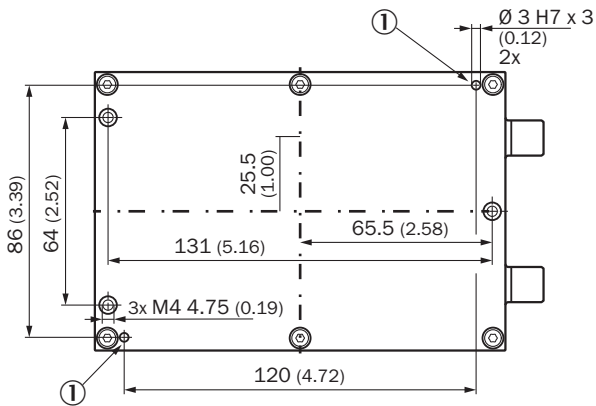

① Ø 3 H7 x 3 holes for accommodating locating pins

Side view with threaded holes for proximity sensors

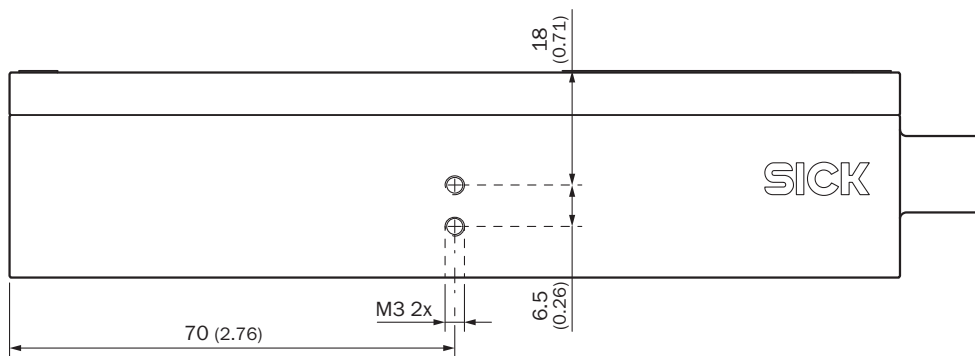

Side view with threaded holes for proximity sensors

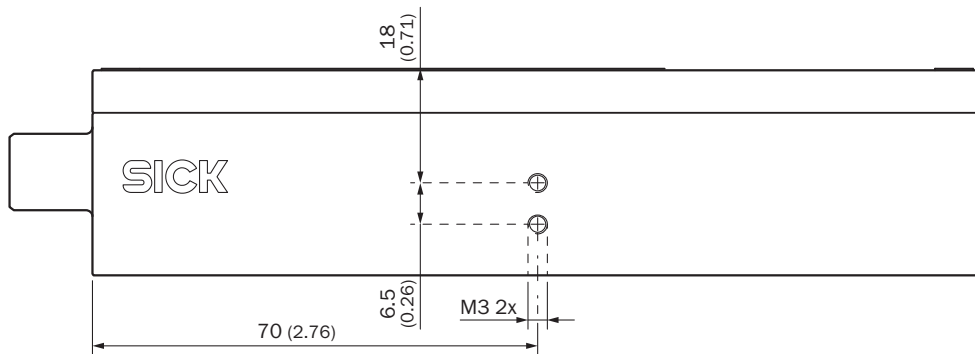

SPEETEC 1D

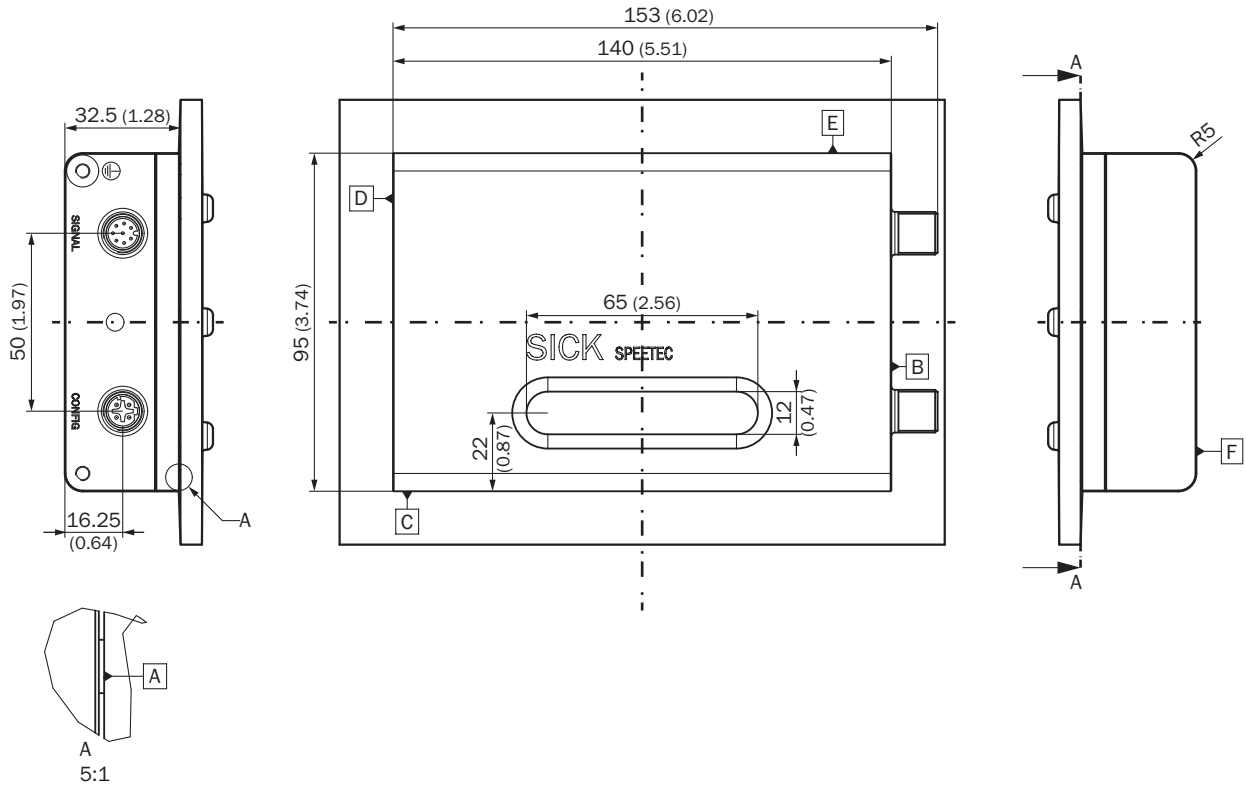

Attachment specifications

Nominal alignment of the sensor to the surface (z-axis)

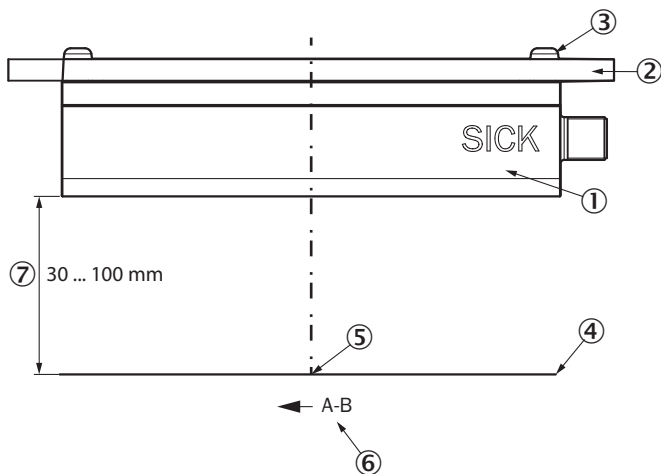

- ① Sensor
- ② Mounting surface
- ③ M4 screws
- ④ Surface to be measured
- ⑤ Measuring point on x-/y-plane, 82.5 mm away from the mounting level
- ⑥ Forward material movement; signal sequence A before B
- ⑦ Measuring distance between sensor and surface, also see "Permissible measuring distance" table

Material	Permissible measuring distance
Wood, sawed	30 ... 100 mm
Paper, white	30 ... 100 mm
Conveyor belt, black	50 ... 80 mm
Textile	40 ... 60 mm

PIN assignment

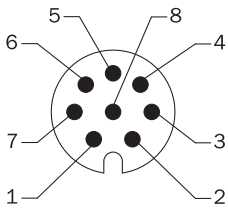

M12 signal male connector, 8-pin and cable, 8-wire

Male connector M12, 8-pin	Wire color	TTL, HTL standard signal	TTL, HTL signal can be programmed	Explanation
1	Brown	A-	A-	Signal cable
2	White	A	A	Signal cable
3	Black	B-	B-	Signal cable
4	Pink	B	B	Signal cable
5	Yellow	Do not wire!	Digital output	Warning: Observe signal variant!
6	Violet	Do not wire!	Digital input	Warning: Observe signal variant!
7	Blue	GND	GND	Ground connection of the sensor
8	Red	+U _S	+U _S	Supply voltage
Screen	Screen	Screen	Screen	Connect screen to housing on sensor side, connect to earth on the control side
Ground	Earthing point on housing			The sensor must be earthed via the housing at the intended earthing point.

Technical data of digital input

Type	Current Sink Type 1/3			
Input voltage HIGH	15 V ... 30 V			
Input voltage LOW	-3 V ... 5 V			
Input current HIGH	2 mA ... 2.6 mA			
Input current LOW	0 mA ... 2.6 mA			

Technical data of digital output

Type	Push-Pull Output			
Output voltage HIGH	(U _S - 2 V) ... U _S			

Male connector M12, 8-pin	Wire color	TTL, HTL standard signal	TTL, HTL signal can be programmed	Explanation
Output voltage LOW	0 V ... 2 V			
Output current HIGH	0.5 mA ... 30 mA			

Diagrams

Signal outputs for electrical interfaces TTL and HTL with forward material movement (see assembly specifications)

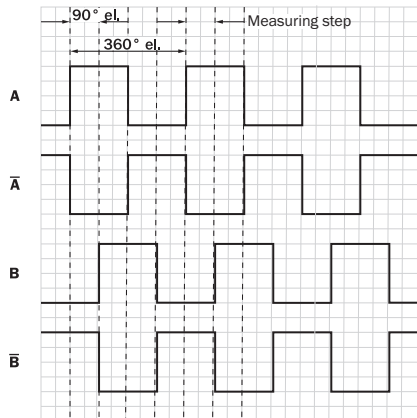

The measuring step corresponds to 90° electrical. The measuring step [$\mu\text{m}/\text{pulse}$] specified under Performance can only be achieved if the output signals of the sensor are evaluated differentially.

Operation note

Permissible deviations from nominal alignment

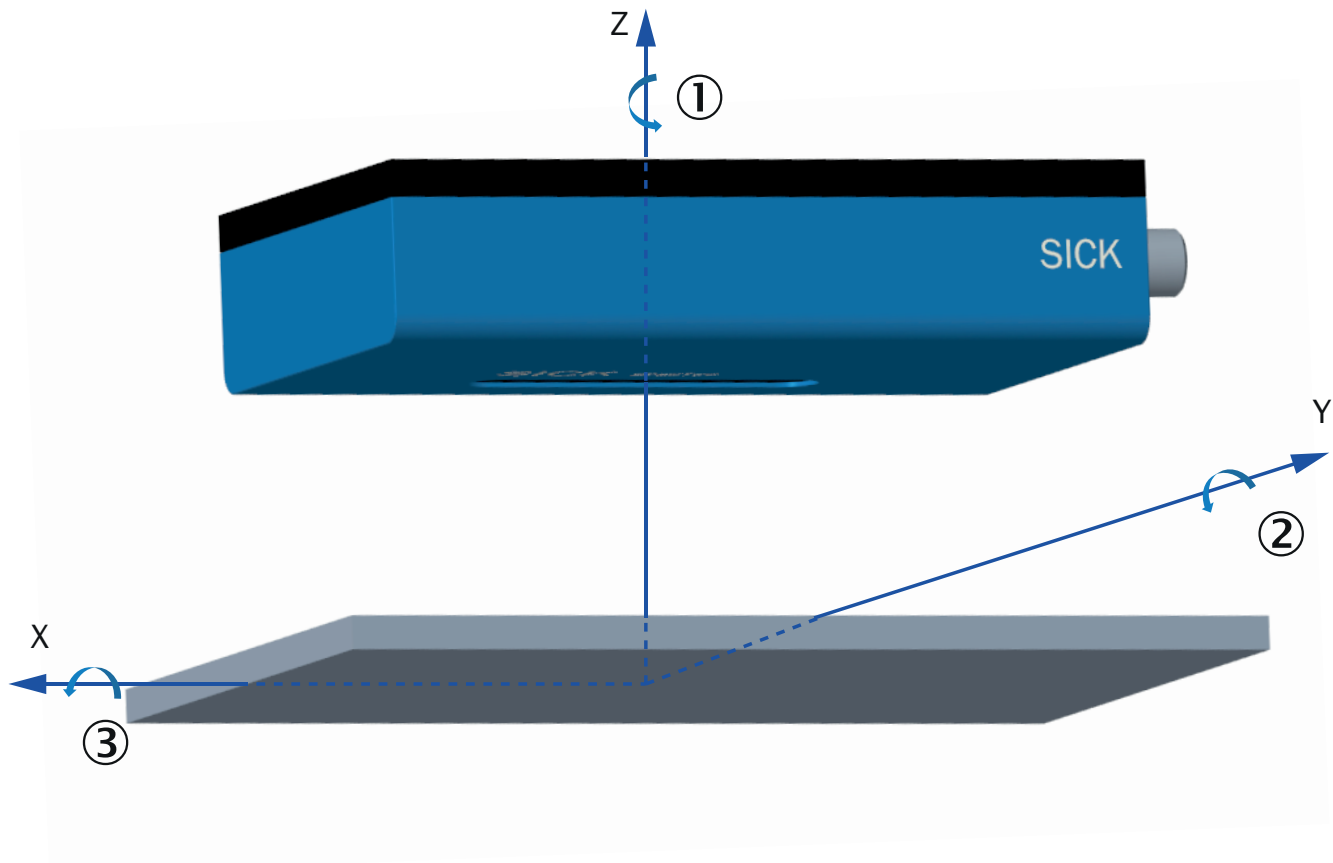

- ① Yaw angle
- ② Pitch angle
- ③ Roll angle



Pitch angle	NCV50B accuracy
0,05°	0,10%
0,10°	0,10%
0,20°	0,10%
0,30°	0,10%
0,50°	0,10%
0,75°	0,10%
1,00°	0,10%
1,50°	0,10%

Recommended accessories

Other models and accessories → www.sick.com/SPEETEC_1D

	Brief description	Type	Part no.
Alignment aids			
	Laser spot detector map to visualize the SPEETEC NCV50 laser spot for the eye and to determine the correct operating point.	BEF-SPEETEC-LSD	2120614
Optics cloths			
	Cloth for cleaning optical surfaces	Lens cloth	4003353
Signal and status indicators			
	Digital display with resistive touch screen, for SPEETEC, incremental encoders and measuring wheel encoders. Multi-function device for use as tachometer, speed measuring device, pulse counter, position display, piece counter and total counter. Communication interface: incremental. Communication interface detailed: RS-422, RS485	DIS-IPDTACCRO000	4119630
Device protection (mechanical)			
	Table housing suitable for installation of the DIS-IPDTACCRO000 display unit	DIS-DH30M	7135599
Mounting brackets and plates			
	Mounting bracket for MWS120 measuring wheel system and SPEETEC 1D laser surface motion sensors	BEF-WF-MWS-NCV	2113284
	1 piece, The BEF-WN-NCV50 mounting bracket makes it possible to easily and correctly mount the sensors while complying with the specified tolerances for distance and angle. The BEF-WN-NCV50 mounting bracket can be combined with the BEF-WF-MWS120 mounting bracket. This makes it possible to mount on the machine frame., Mounting bracket, screws for mounting the NCV50	BEF-WN-NCV50 mounting bracket	2117456
Terminal and alignment brackets			
	1 piece, Bracket for mounting SICK photoelectric proximity sensors, W4, W9, G6 to the NCV50. SICK photoelectric proximity sensors from the W4, W9, G6 series can be easily mounted on the NCV50 using the BEF-MK-NCV50-W49G6. This makes it possible to better detect material edges and makes length measurement more exact. The position of the scanning point in the direction of movement is specified by the mounting position, the position in the y-direction can be adjusted using the bracket slots., Adjustment aid, screws for mounting the photoelectric proximity sensor	BEF-MK-NCV50-W49G6	2117457
	Suitable for NCV50 / SPEETEC. Simplifies mounting of the SPEETEC at the right distance and angle to the surface. Packaging unit: 1 unit, Adjustment aid, screws for mounting the NCV50	BEF-WN-NCV50-ADJUST	2117003
Others			
	<ul style="list-style-type: none"> • Connection type head A: Female connector, M12, 8-pin, straight • Connection type head B: Flying leads • Signal type: Incremental, SSI • Cable: 2 m, 8-wire, PUR, halogen-free • Description: Incremental, SSI, shielded, Head A: female connector, M12, 8-pin, straight Head B: cable Cable: suitable for drag chain, PVC, shielded, 4 x 2 x 0.25 mm², Ø 7.0 mm • Connection systems: Flying leads 	DOL-1208-G02MAC1	6032866

	Brief description	Type	Part no.
	<ul style="list-style-type: none"> • Connection type head A: Female connector, M12, 8-pin, straight • Connection type head B: Flying leads • Signal type: Incremental, SSI • Cable: 5 m, 8-wire, PUR, halogen-free • Description: Incremental, SSI, shielded, Head A: female connector, M12, 8-pin, straight Head B: cable Cable: suitable for drag chain, PVC, shielded, 4 x 2 x 0.25 mm², Ø 7.0 mm • Connection systems: Flying leads 	DOL-1208-G05MAC1	6032867
		DOL-1208-G05MAD3	2121359
	<ul style="list-style-type: none"> • Connection type head A: Female connector, M12, 8-pin, straight • Connection type head B: Flying leads • Signal type: Incremental, SSI • Cable: 10 m, 8-wire, PUR, halogen-free • Description: Incremental, SSI, shielded, Head A: female connector, M12, 8-pin, straight Head B: cable Cable: suitable for drag chain, PVC, shielded, 4 x 2 x 0.25 mm², Ø 7.0 mm • Connection systems: Flying leads 	DOL-1208-G10MAC1	6032868
	<ul style="list-style-type: none"> • Connection type head A: Female connector, M12, 8-pin, straight • Connection type head B: Flying leads • Signal type: Incremental, SSI • Cable: 20 m, 8-wire, PUR, halogen-free • Description: Incremental, SSI, shielded, Head A: female connector, M12, 8-pin, straight Head B: cable Cable: suitable for drag chain, PVC, shielded, 4 x 2 x 0.25 mm², Ø 7.0 mm • Connection systems: Flying leads 	DOL-1208-G20MAC1	6032869
	<ul style="list-style-type: none"> • Connection type head A: Female connector, M12, 8-pin, straight • Connection type head B: Male connector, M12, 8-pin, straight • Cable: 5 m, 8-wire, PUR, halogen-free • Description: Shielded, Connection cable, M12, 8-pin, straight male connector / straight female connector, 2 m, PUR halogen-free, shielded 	DSL-1208-G05MAC1	6032913
	<ul style="list-style-type: none"> • Connection type head A: Flying leads • Connection type head B: Flying leads • Signal type: SSI, Incremental • Items supplied: By the meter • Cable: 11-wire, PUR • Description: SSI, Incremental, shielded 	LTG-2411-MW	6027530
	<ul style="list-style-type: none"> • Connection type head A: Flying leads • Connection type head B: Flying leads • Signal type: SSI, Incremental • Items supplied: By the meter • Cable: 12-wire, PUR, halogen-free • Description: SSI, Incremental, shielded 	LTG-2512-MW	6027531
	<ul style="list-style-type: none"> • Connection type head A: Flying leads • Connection type head B: Flying leads • Signal type: SSI, TTL, HTL, Incremental • Items supplied: By the meter • Cable: 12-wire, UV and saltwater-resistant, PUR, halogen-free • Description: SSI, TTL, HTL, Incremental, shielded, Head A: cable Head B: cable Cable: suitable for drag chain, PUR, halogen-free, shielded, UV and saltwater resistant, 4 x 2 x 0.25 mm² + 2 x 0.5 mm² + 2 x 0.14 mm², Ø 7.8 mm 	LTG-2612-MW	6028516
	<ul style="list-style-type: none"> • Connection type head A: Female connector, M12, 8-pin, straight, A-coded • Description: Shielded • Connection systems: Screw-type terminals • Permitted cross-section: 0.25 mm² ... 0.5 mm² 	DOS-1208-GA	6028369
	<ul style="list-style-type: none"> • Connection type head A: Male connector, M12, 8-pin, straight, A-coded • Description: Shielded • Connection systems: Screw-type terminals • Permitted cross-section: ≤ 0.5 mm² 	STE-1208-GA	6028370

	Brief description	Type	Part no.
	<ul style="list-style-type: none"> • Connection type head A: Female connector, M12, 8-pin, angled • Connection type head B: Flying leads • Signal type: HIPERFACE[®], Incremental • Cable: 20 m, 8-wire, PUR • Description: HIPERFACE[®], Incremental, shielded 	DOL-1208-W20MAC1	6037727
	<ul style="list-style-type: none"> • Connection type head A: Female connector, M12, 8-pin, angled • Connection type head B: Flying leads • Signal type: HIPERFACE[®], Incremental • Cable: 2 m, 8-wire, PUR, halogen-free • Description: HIPERFACE[®], Incremental, shielded 	DOL-1208-W02MAC1	6037724
	<ul style="list-style-type: none"> • Connection type head A: Female connector, M12, 8-pin, angled • Connection type head B: Flying leads • Signal type: HIPERFACE[®], Incremental • Cable: 5 m, 8-wire, PUR, halogen-free • Description: HIPERFACE[®], Incremental, shielded 	DOL-1208-W05MAC1	6037725
	<ul style="list-style-type: none"> • Connection type head A: Female connector, M12, 8-pin, angled • Connection type head B: Flying leads • Signal type: HIPERFACE[®], Incremental • Cable: 10 m, 8-wire, PUR, halogen-free • Description: HIPERFACE[®], Incremental, shielded 	DOL-1208-W10MAC1	6037726
	<ul style="list-style-type: none"> • Connection type head A: Female connector, M12, 8-pin, angled, A-coded • Signal type: Ethernet • Cable: CAT5, CAT5e • Description: Ethernet, shielded, M12 female connector, A-coded • Connection systems: QUICKON connection • Permitted cross-section: 0.14 mm² ... 0.34 mm² 	DOS-1208-WA	6043358
Photoelectric sensors			
	WTB4SL-3P3261	WTB4SL-3P3261	1058238

SICK AT A GLANCE

SICK is one of the leading manufacturers of intelligent sensors and sensor solutions for industrial applications. A unique range of products and services creates the perfect basis for controlling processes securely and efficiently, protecting individuals from accidents and preventing damage to the environment.

We have extensive experience in a wide range of industries and understand their processes and requirements. With intelligent sensors, we can deliver exactly what our customers need. In application centers in Europe, Asia and North America, system solutions are tested and optimized in accordance with customer specifications. All this makes us a reliable supplier and development partner.

Comprehensive services complete our offering: SICK LifeTime Services provide support throughout the machine life cycle and ensure safety and productivity.

For us, that is “Sensor Intelligence.”

WORLDWIDE PRESENCE:

Contacts and other locations –www.sick.com