



# OD1-B100H50I25

OD Mini

DISPLACEMENT MEASUREMENT SENSORS

**SICK**  
Sensor Intelligence.



### Ordering information

Type	Part no.
OD1-B100H50I25	6050512

Other models and accessories → [www.sick.com/OD\\_Mini](http://www.sick.com/OD_Mini)



### Detailed technical data

#### Features

<b>Measuring range</b>	50 mm ... 150 mm
<b>Target</b>	Natural objects
<b>Repeatability</b>	20 µm <sup>1) 2)</sup>
<b>Linearity</b>	± 100 µm <sup>3)</sup>
<b>Response time</b>	≥ 2 ms <sup>4)</sup>
<b>Output time</b>	≥ 0.5 ms
<b>Light source</b>	Laser, red visible red light
<b>Type of light</b>	Visible red light
<b>Laser class</b>	1 (IEC 60825-1:2014, EN 60825-1:2014) <sup>5)</sup>
<b>Typ. light spot size (distance)</b>	700 µm x 600 µm (100 mm)
<b>Additional function</b>	Averaging 1 ... 512x Automatic or manual sensitivity adjustment Analog outputs can be taught in Digital outputs can be taught in Invertable digital output Switching mode: window (Wnd) Switching mode: distance to object (DtO) Switching mode: object between sensor and background (ObSB) Multifunctional input: laser-off / external teach-in / trigger
<b>General notes</b>	Note Not free of paint wetting impairment substances.
<b>Safety-related parameters</b>	MTTF <sub>D</sub> 101 years

<sup>1)</sup> Averaging function set to: 512.

<sup>2)</sup> Constant ambient conditions.

<sup>3)</sup> Measurement on 90 % remission (ceramic, white).

<sup>4)</sup> With fixed sensitivity adjustment and averaging setting = 1. With automatic sensitivity and measuring rate 500 µs: 2 ... 7.5 ms response time/measuring rate  
1,000 µs: 4 ... 15 ms response time.

<sup>5)</sup> Wavelength: 655 nm, max. output: 390 µW (laser class 1) / < 1 mW (laser class 2).

<b>DC<sub>avg</sub></b>	0%
-------------------------	----

- 1) Averaging function set to: 512.
- 2) Constant ambient conditions.
- 3) Measurement on 90 % remission (ceramic, white).
- 4) With fixed sensitivity adjustment and averaging setting = 1. With automatic sensitivity and measuring rate 500 μs: 2 ... 7.5 ms response time/measuring rate 1,000 μs: 4 ... 15 ms response time.
- 5) Wavelength: 655 nm, max. output: 390 μW (laser class 1) / < 1 mW (laser class 2).

## Interfaces

<b>Digital output</b>	
Number	1
Type	PNP/NPN, selectable
<b>Analog output</b>	
Number	1
Type	Current output
Current	4 mA ... 20 mA, ≤ 300 Ω
Resolution	13.4 bit
<b>Multifunctional input (MF)</b>	
	1 x <sup>1)</sup>

<sup>1)</sup> MF can be used as laser-off, trigger, external teach-in or deactivated.

## Electronics

<b>Supply voltage U<sub>B</sub></b>	DC 12 V (-5 %) ... DC 24 V (+10 %)
<b>Power consumption</b>	≤ 1.92 W <sup>1)</sup>
<b>Warm-up time</b>	≤ 5 min
<b>Indication</b>	4-digit 7-segment display (plus 4 LEDs for status display)
<b>Enclosure rating</b>	IP67
<b>Protection class</b>	III

<sup>1)</sup> Without load, with current output.

## Mechanics

<b>Dimensions (W x H x D)</b>	17.8 mm x 44.4 mm x 31 mm
<b>Control elements</b>	4 buttons
<b>Housing material</b>	Stainless steel
<b>Window material</b>	Plastic (PPSU)
<b>Weight</b>	70 g
<b>Connection type</b>	Cable with male connector, M12, 5-pin, 30 cm

## Ambient data

<b>Ambient temperature, operation</b>	-10 °C ... +50 °C
<b>Ambient temperature, storage</b>	-20 °C ... +60 °C
<b>Min. rel. humidity (not condensing)</b>	35 %
<b>Max. rel. humidity (not condensing)</b>	95 %
<b>Temperature drift</b>	± 0.08 % FS/K (FS = Full Scale = Measuring range of sensor)
<b>Typ. Ambient light immunity</b>	Artificial light: ≤ 3,000 lx Sunlight: ≤ 10,000 lx
<b>Vibration resistance</b>	10 Hz ... 55 Hz (amplitude 1.5 mm, x-, y-, z-axis 2 hours each)

<b>Shock resistance</b>	50 G (x, y, z axis 3 times each)
-------------------------	----------------------------------

### Classifications

<b>ECLASS 5.0</b>	27270801
<b>ECLASS 5.1.4</b>	27270801
<b>ECLASS 6.0</b>	27270801
<b>ECLASS 6.2</b>	27270801
<b>ECLASS 7.0</b>	27270801
<b>ECLASS 8.0</b>	27270801
<b>ECLASS 8.1</b>	27270801
<b>ECLASS 9.0</b>	27270801
<b>ECLASS 10.0</b>	27270801
<b>ECLASS 11.0</b>	27270801
<b>ECLASS 12.0</b>	27270916
<b>ETIM 5.0</b>	EC001825
<b>ETIM 6.0</b>	EC001825
<b>ETIM 7.0</b>	EC001825
<b>ETIM 8.0</b>	EC001825
<b>UNSPSC 16.0901</b>	41111613

### Dimensional drawing (Dimensions in mm (inch))

Stainless steel housing

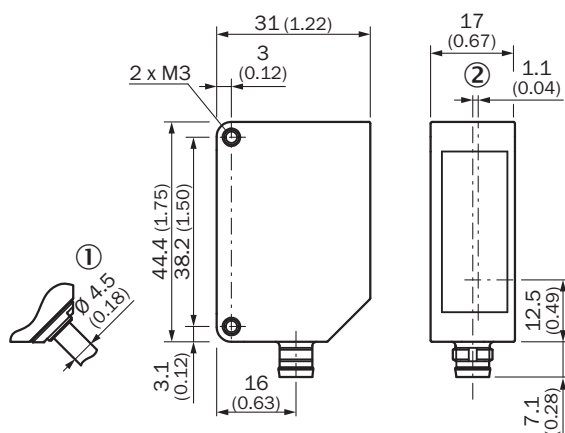

- ① Variant with 30 cm cable with M12, 5-pin connector
- ② Optical axis

## Connection type

Connection type

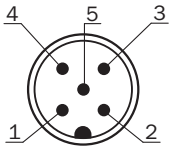

## Connection diagram

Connection diagram

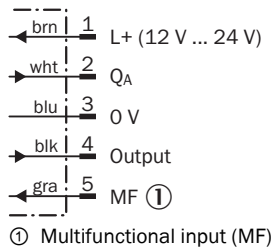

## Adjustment possible

Adjustments

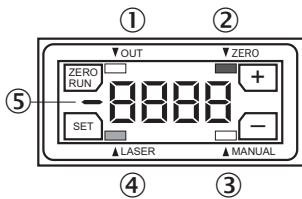

- ① Digital output status indicator
- ② Zero offset status indicator
- ③ Teach mode status indicator
- ④ Laser status indicator
- ⑤ Minus sign for measured value indicator

## Light spot size

OD Mini Prime 50 mm ... 150 mm

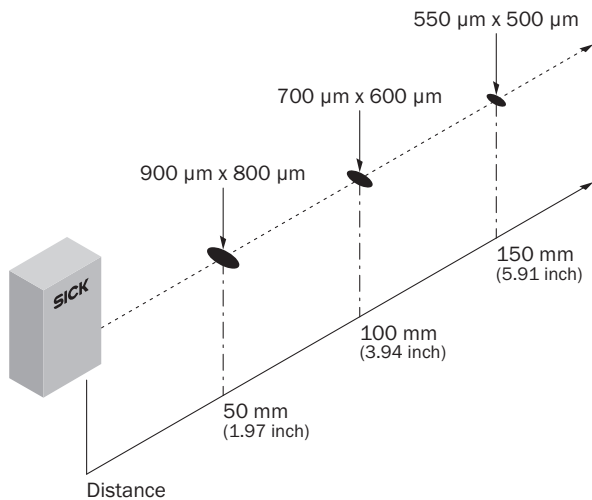

## Linearity

Linearity



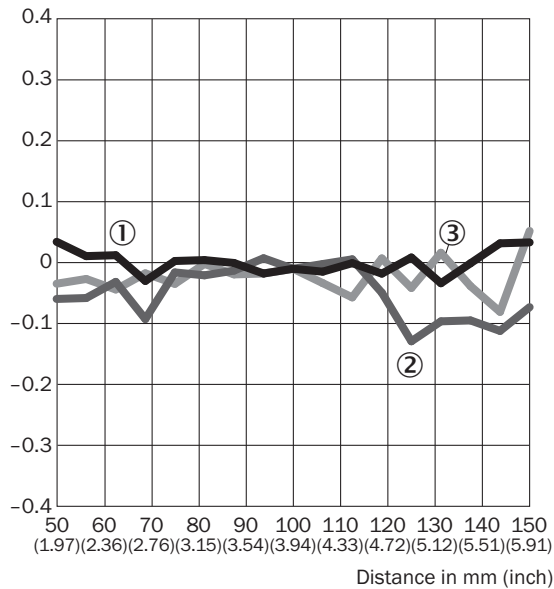

Linearity [% FS]



- ① White ceramic
- ② Stainless steel
- ③ Black rubber

## Recommended accessories

Other models and accessories → [www.sick.com/OD\\_Mini](http://www.sick.com/OD_Mini)

	Brief description	Type	Part no.
<b>Mounting brackets and plates</b>			
	Mounting bracket, for wall installation, no alignment bracket, stainless steel	BEF-OD1-A	5328343
	Mounting bracket, no alignment bracket, stainless steel	BEF-OD1-B	5328344
<b>Others</b>			
	<ul style="list-style-type: none"> <li>• <b>Connection type head A:</b> Female connector, M12, 4-pin, straight</li> <li>• <b>Connection type head B:</b> Male connector, M8, 4-pin</li> <li>• <b>Cable:</b> 2 m, PUR</li> <li>• <b>Description:</b> Highly flexible</li> </ul>	DSL-2804-G02MB	6059743
	<ul style="list-style-type: none"> <li>• <b>Connection type head A:</b> Female connector, M12, 4-pin, straight, A-coded</li> <li>• <b>Connection type head B:</b> Male connector, M8, 4-pin, straight, A-coded</li> <li>• <b>Signal type:</b> Sensor/actuator cable</li> <li>• <b>Cable:</b> 2 m, 4-wire, PUR, halogen-free</li> <li>• <b>Description:</b> Sensor/actuator cable, unshielded</li> <li>• <b>Application:</b> Zones with oils and lubricants, Drag chain operation, Robot</li> </ul>	YF2A14-020UA3M8U14	2096112
	<ul style="list-style-type: none"> <li>• <b>Connection type head A:</b> Female connector, M12, 5-pin, straight, A-coded</li> <li>• <b>Connection type head B:</b> Flying leads</li> <li>• <b>Signal type:</b> Sensor/actuator cable</li> <li>• <b>Cable:</b> 2 m, 5-wire, PUR, halogen-free</li> <li>• <b>Description:</b> Sensor/actuator cable, unshielded</li> <li>• <b>Application:</b> Zones with oils and lubricants, Drag chain operation, Robot</li> </ul>	YF2A15-020UB5XLEAX	2095617

## Recommended services

Additional services → [www.sick.com/OD\\_Mini](http://www.sick.com/OD_Mini)

	Type	Part no.
<b>Commissioning</b>		
<ul style="list-style-type: none"> <li>• <b>Product area:</b> Displacement measurement sensors</li> <li>• <b>Range of services:</b> Inspection of connection and mounting, optimization of parameters of SICK product as well as tests, set-up of previously defined functions of the scaling of the analog measuring range, switching point position, hysteresis, measuring frequency, measured value filter, signal quality, evaluation function, or communication interface</li> <li>• <b>Travel expenses:</b> The prices do not include travel costs such as hotel, flight, travel time and expenses.</li> <li>• <b>Duration:</b> Additional work will be invoiced separately</li> </ul>	DT20 Hi/OD/OL commissioning	1612241

## SICK AT A GLANCE

SICK is one of the leading manufacturers of intelligent sensors and sensor solutions for industrial applications. A unique range of products and services creates the perfect basis for controlling processes securely and efficiently, protecting individuals from accidents and preventing damage to the environment.

We have extensive experience in a wide range of industries and understand their processes and requirements. With intelligent sensors, we can deliver exactly what our customers need. In application centers in Europe, Asia and North America, system solutions are tested and optimized in accordance with customer specifications. All this makes us a reliable supplier and development partner.

Comprehensive services complete our offering: SICK LifeTime Services provide support throughout the machine life cycle and ensure safety and productivity.

For us, that is “Sensor Intelligence.”

## WORLDWIDE PRESENCE:

Contacts and other locations –[www.sick.com](http://www.sick.com)