



OD1-B100H50U25

OD Mini

DISPLACEMENT MEASUREMENT SENSORS

SICK
Sensor Intelligence.



Ordering information

Type	Part no.
OD1-B100H50U25	6050514

Other models and accessories → www.sick.com/OD_Mini



Detailed technical data

Features

Measuring range	50 mm ... 150 mm
Target	Natural objects
Repeatability	20 µm ^{1) 2)}
Linearity	± 100 µm ³⁾
Response time	≥ 2 ms ⁴⁾
Output time	≥ 0.5 ms
Light source	Laser, red visible red light
Type of light	Visible red light
Laser class	1 (IEC 60825-1:2014, EN 60825-1:2014) ⁵⁾
Typ. light spot size (distance)	700 µm x 600 µm (100 mm)
Additional function	Averaging 1 ... 512x Automatic or manual sensitivity adjustment Analog outputs can be taught in Digital outputs can be taught in Invertable digital output Switching mode: window (Wnd) Switching mode: distance to object (DtO) Switching mode: object between sensor and background (ObSB) Multifunctional input: laser-off / external teach-in / trigger
General notes	Note Not free of paint wetting impairment substances.
Safety-related parameters	MTTF _D 101 years

¹⁾ Averaging function set to: 512.

²⁾ Constant ambient conditions.

³⁾ Measurement on 90 % remission (ceramic, white).

⁴⁾ With fixed sensitivity adjustment and averaging setting = 1. With automatic sensitivity and measuring rate 500 µs: 2 ... 7.5 ms response time/measuring rate
1,000 µs: 4 ... 15 ms response time.

⁵⁾ Wavelength: 655 nm, max. output: 390 µW (laser class 1) / < 1 mW (laser class 2).

DC_{avg}	0%
-------------------------	----

- 1) Averaging function set to: 512.
- 2) Constant ambient conditions.
- 3) Measurement on 90 % remission (ceramic, white).
- 4) With fixed sensitivity adjustment and averaging setting = 1. With automatic sensitivity and measuring rate 500 µs: 2 ... 7.5 ms response time/measuring rate 1,000 µs: 4 ... 15 ms response time.
- 5) Wavelength: 655 nm, max. output: 390 µW (laser class 1) / < 1 mW (laser class 2).

Interfaces

Digital output	
Number	1
Type	PNP/NPN, selectable
Analog output	
Number	1
Type	Voltage output
Voltage	0 V ... 10 V, > 10,000 Ω
Resolution	13.4 bit
Multifunctional input (MF)	
	1 x ¹⁾

¹⁾ MF can be used as laser-off, trigger, external teach-in or deactivated.

Electronics

Supply voltage U_B	DC 12 V (-5 %) ... DC 24 V (+10 %)
Power consumption	≤ 1.92 W ¹⁾
Warm-up time	≤ 5 min
Indication	4-digit 7-segment display (plus 4 LEDs for status display)
Enclosure rating	IP67
Protection class	III

¹⁾ Without load, with current output.

Mechanics

Dimensions (W x H x D)	17.8 mm x 44.4 mm x 31 mm
Control elements	4 buttons
Housing material	Stainless steel
Window material	Plastic (PPSU)
Weight	70 g
Connection type	Cable with male connector, M12, 5-pin, 30 cm

Ambient data

Ambient temperature, operation	-10 °C ... +50 °C
Ambient temperature, storage	-20 °C ... +60 °C
Min. rel. humidity (not condensing)	35 %
Max. rel. humidity (not condensing)	95 %
Temperature drift	± 0.08 % FS/K (FS = Full Scale = Measuring range of sensor)
Typ. Ambient light immunity	Artificial light: ≤ 3,000 lx Sunlight: ≤ 10,000 lx
Vibration resistance	10 Hz ... 55 Hz (amplitude 1.5 mm, x-, y-, z-axis 2 hours each)

Shock resistance	50 G (x, y, z axis 3 times each)
-------------------------	----------------------------------

Classifications

ECLASS 5.0	27270801
ECLASS 5.1.4	27270801
ECLASS 6.0	27270801
ECLASS 6.2	27270801
ECLASS 7.0	27270801
ECLASS 8.0	27270801
ECLASS 8.1	27270801
ECLASS 9.0	27270801
ECLASS 10.0	27270801
ECLASS 11.0	27270801
ECLASS 12.0	27270916
ETIM 5.0	EC001825
ETIM 6.0	EC001825
ETIM 7.0	EC001825
ETIM 8.0	EC001825
UNSPSC 16.0901	41111613

Dimensional drawing (Dimensions in mm (inch))

Stainless steel housing

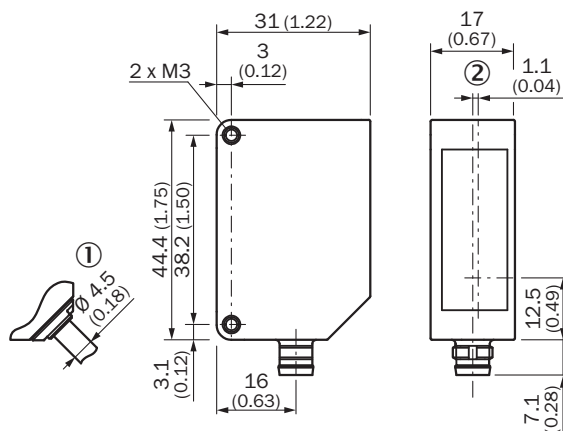

- ① Variant with 30 cm cable with M12, 5-pin connector
- ② Optical axis

Connection type

Connection type

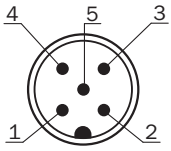

Connection diagram

Connection diagram

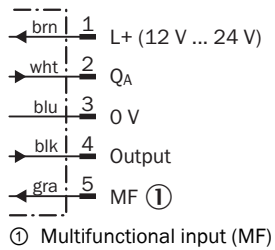

Adjustment possible

Adjustments

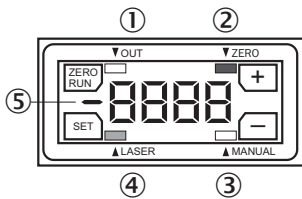

- ① Digital output status indicator
- ② Zero offset status indicator
- ③ Teach mode status indicator
- ④ Laser status indicator
- ⑤ Minus sign for measured value indicator

Light spot size

OD Mini Prime 50 mm ... 150 mm

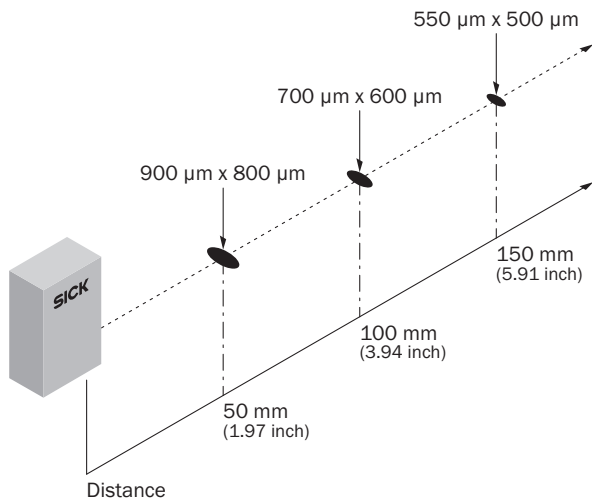

Linearity

Linearity



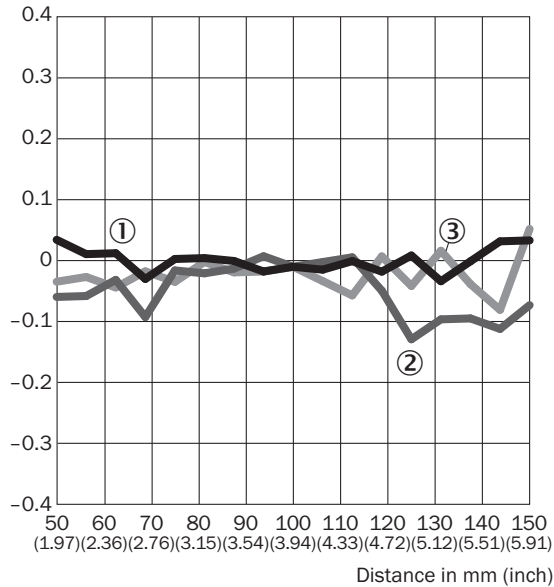

Linearity [% FS]



- ① White ceramic
- ② Stainless steel
- ③ Black rubber

Recommended accessories

Other models and accessories → www.sick.com/OD_Mini

	Brief description	Type	Part no.
Mounting brackets and plates			
	Mounting bracket, for wall installation, no alignment bracket, stainless steel	BEF-OD1-A	5328343
	Mounting bracket, no alignment bracket, stainless steel	BEF-OD1-B	5328344
Others			
	<ul style="list-style-type: none"> • Connection type head A: Female connector, M12, 4-pin, straight • Connection type head B: Male connector, M8, 4-pin • Cable: 2 m, PUR • Description: Highly flexible 	DSL-2804-G02MB	6059743
	<ul style="list-style-type: none"> • Connection type head A: Female connector, M12, 4-pin, straight, A-coded • Connection type head B: Male connector, M8, 4-pin, straight, A-coded • Signal type: Sensor/actuator cable • Cable: 2 m, 4-wire, PUR, halogen-free • Description: Sensor/actuator cable, unshielded • Application: Zones with oils and lubricants, Drag chain operation, Robot 	YF2A14-020UA3M8U14	2096112
	<ul style="list-style-type: none"> • Connection type head A: Female connector, M12, 5-pin, straight, A-coded • Connection type head B: Flying leads • Signal type: Sensor/actuator cable • Cable: 2 m, 5-wire, PUR, halogen-free • Description: Sensor/actuator cable, unshielded • Application: Zones with oils and lubricants, Drag chain operation, Robot 	YF2A15-020UB5XLEAX	2095617

Recommended services

Additional services → www.sick.com/OD_Mini

	Type	Part no.
Commissioning		
<ul style="list-style-type: none"> • Product area: Displacement measurement sensors • Range of services: Inspection of connection and mounting, optimization of parameters of SICK product as well as tests, set-up of previously defined functions of the scaling of the analog measuring range, switching point position, hysteresis, measuring frequency, measured value filter, signal quality, evaluation function, or communication interface • Travel expenses: The prices do not include travel costs such as hotel, flight, travel time and expenses. • Duration: Additional work will be invoiced separately 	DT20 Hi/OD/OL commissioning	1612241

SICK AT A GLANCE

SICK is one of the leading manufacturers of intelligent sensors and sensor solutions for industrial applications. A unique range of products and services creates the perfect basis for controlling processes securely and efficiently, protecting individuals from accidents and preventing damage to the environment.

We have extensive experience in a wide range of industries and understand their processes and requirements. With intelligent sensors, we can deliver exactly what our customers need. In application centers in Europe, Asia and North America, system solutions are tested and optimized in accordance with customer specifications. All this makes us a reliable supplier and development partner.

Comprehensive services complete our offering: SICK LifeTime Services provide support throughout the machine life cycle and ensure safety and productivity.

For us, that is “Sensor Intelligence.”

WORLDWIDE PRESENCE:

Contacts and other locations –www.sick.com