



OD2000-3502T15

OD2000

DISPLACEMENT MEASUREMENT SENSORS

SICK
Sensor Intelligence.



Ordering information

Type	Part no.
OD2000-3502T15	6074384

Other models and accessories → www.sick.com/OD2000



Detailed technical data

Features

Measuring range	100 mm ... 600 mm ¹⁾
Target	Natural objects
Repeatability	20 µm ^{2) 3) 4)}
Linearity	± 500 µm ^{2) 4) 5)}
Response time	≥ 0.533 ms ⁶⁾
Output time	≥ 0.1333 ms
Light source	Laser, red visible red light
Type of light	Visible red light
Laser class	2 (IEC 60825-1:2014, EN 60825-1:2014) ⁷⁾
Typ. light spot size (distance)	Ø 600 µm (350 mm)
Additional function	Adjustable average value or media filter Switching mode: Distance to Object (DtO) / switching window / object between sensor and background (ObSB) Teach-in of digital output Invertable digital output Teach-in of analog output Invertable analog output Switchable analog output (mA / V) Multifunctional input: sender off/hold functions/deactivated Switch-off display

¹⁾ 6 % ... 90 % remission; at default settings.

²⁾ Measurement on 60 % remission (ceramic, white).

³⁾ Average value setting: 512, median: 31, measuring frequency: 5 kHz, in the middle of the measuring range, for static measurement.

⁴⁾ At T = +25 °C, under constant general conditions.

⁵⁾ Observe min. warm-up time of 30 minutes.

⁶⁾ Dependent on the set average or sensitivity.

⁷⁾ Visible, wavelength: 655 nm, max. average power: 1 mW, max. pulse power: 1 mW, max. pulse duration: 5 ms.

	Lock user interface Display can be rotated by 180° Alarm function Edge height jump Time functions (ON/OFF delay, 1 shot) region of interest
Safety-related parameters	
	MTTF _D 107 years
	DC _{avg} 0%

- 1) 6 % ... 90 % remission; at default settings.
- 2) Measurement on 60 % remission (ceramic, white).
- 3) Average value setting: 512, median: 31, measuring frequency: 5 kHz, in the middle of the measuring range, for static measurement.
- 4) At T = +25 °C, under constant general conditions.
- 5) Observe min. warm-up time of 30 minutes.
- 6) Dependent on the set average or sensitivity.
- 7) Visible, wavelength: 655 nm, max. average power: 1 mW, max. pulse power: 1 mW, max. pulse duration: 5 ms.

Interfaces

IO-Link	✓, IO-Link V1.1
Function	Process data, parameterization, diagnosis, data storage
Data transmission rate	230,4 kbit/s (COM3), Process data length 6 bytes, min. cycle time 0.7 ms
Digital input	In ₁ Can be used as sender off, trigger for hold functions, or deactivated
Digital output	
Number	2 ¹⁾
Type	PNP/NPN, selectable
Analog output	
Number	1
Type	Current output / voltage output
Function	Selectable
Current	4 mA ... 20 mA, ≤ 300 Ω
Voltage	0 V ... 10 V, > 10,000 Ω
Resolution	16 bit

¹⁾ PNP/PP: HIGH = UV > 13.5 V/LOW = UV < 8 V; NPN: HIGH = UV < 8 V/LOW = UV > 13.5 V.

Electronics

Supply voltage U_B	DC 18 V ... 24 V, ± 10%, including residual ripple ¹⁾
Power consumption	1.5 W, At 24 V DC ²⁾
Warm-up time	< 30 min
Indication	OLED display, status LEDs
Enclosure rating	IP67
Protection class	III (EN 50178)
Electrical safety	IEC 61010-1 AMD 1:2016-12

- 1) Limit values, reverse-polarity protected.
- 2) Without load, at +20 °C.

Mechanics

Dimensions (W x H x D)	27 mm x 60 mm x 50 mm
-------------------------------	-----------------------

Control elements	4 buttons
Housing material	Plastic (PBT)
Window material	Plastic (PMMA)
Weight	90 g
Connection type	Cable with male connector, M12, 5-pin, A-coded, 30 cm

Ambient data

Ambient temperature, operation	-10 °C ... +50 °C, Operating temperature at $V_S = 24\text{ V}$
Ambient temperature, storage	-20 °C ... +60 °C
Relative air humidity (non-condensing)	35 % ... 85 %
Temperature drift	300 $\mu\text{m}/\text{K}$
Typ. Ambient light immunity	Artificial light: $\leq 3,000\text{ lx}$ ¹⁾ Sunlight: $\leq 10,000\text{ lx}$
Vibration resistance	EN 60068-2-6, EN 60068-2-64
Shock resistance	EN 60068-2-27

¹⁾ With constant object movement in the measuring range.

Classifications

ECLASS 5.0	27270801
ECLASS 5.1.4	27270801
ECLASS 6.0	27270801
ECLASS 6.2	27270801
ECLASS 7.0	27270801
ECLASS 8.0	27270801
ECLASS 8.1	27270801
ECLASS 9.0	27270801
ECLASS 10.0	27270801
ECLASS 11.0	27270801
ECLASS 12.0	27270916
ETIM 5.0	EC001825
ETIM 6.0	EC001825
ETIM 7.0	EC001825
ETIM 8.0	EC001825
UNSPSC 16.0901	41111613

Dimensional drawing (Dimensions in mm (inch))

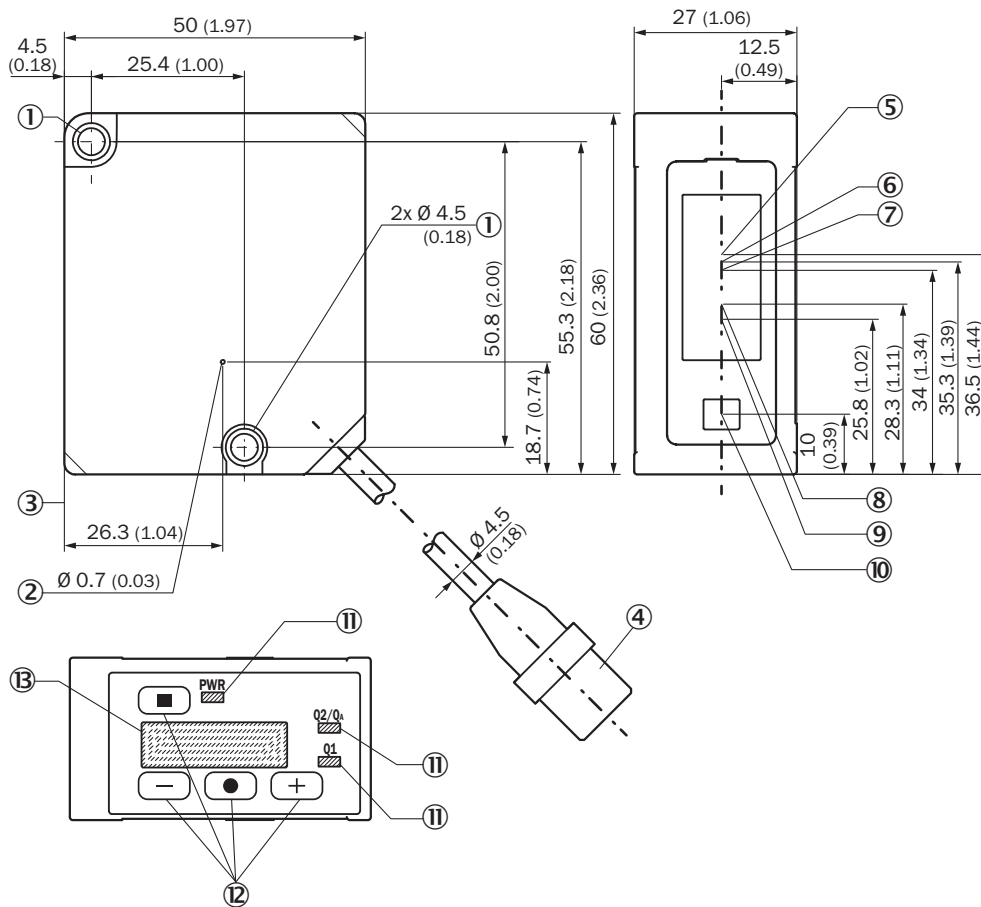

Structure and device dimensions, unit: mm (inch), decimal separator: period

- ① M4 fixing holes
- ② Ventilation opening (do not cover)
- ③ Device zero point (distance = 0 mm)
- ④ Device cable (length: 300 mm) with male connector, M12, 5-pin, A-coded
- ⑤ Center of optical axis, receiver (device type OD2000-350, OD2000-700)
- ⑥ Center of optical axis, receiver (device type OD2000-245)
- ⑦ Center of optical axis, receiver (device type OD2000-130)
- ⑧ Center of optical axis, receiver (device type OD2000-050)
- ⑨ Center of optical axis, receiver (device type OD2000-030)
- ⑩ Center of optical axis, sender
- ⑪ Status LEDs
- ⑫ Control elements
- ⑬ Display

Interference diagram

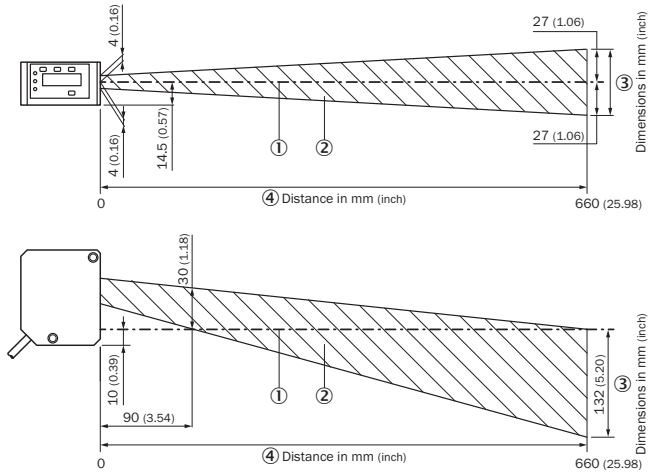

- ① Optical axis sender and receiver
- ② Interference range
- ③ Dimensions in mm (inch)
- ④ Distance in mm (inch)

Connection diagram

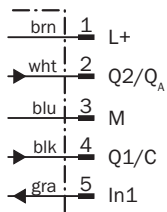

- ① Brown
- ② White
- ③ Blue
- ④ Black
- ⑤ Gray

Light spot size

Typical light spot size OD2000-350xxx

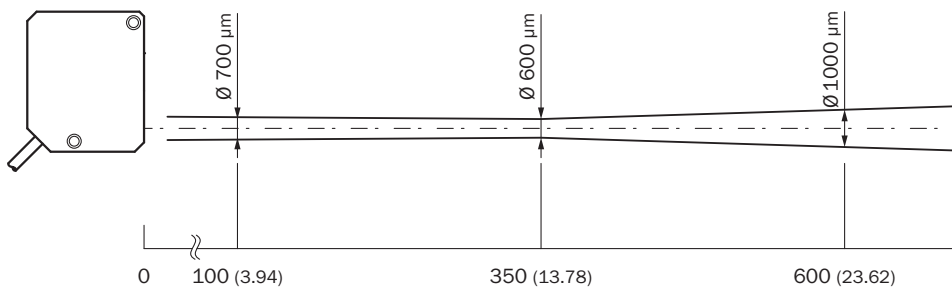

Unit: mm (inch), decimal separator: period

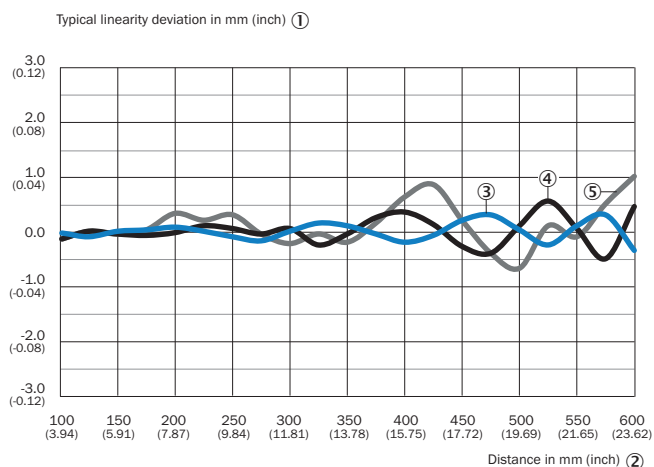

Linearity



- ① Typical linearity deviation in mm (inch)
- ② Distance in mm (inch)
- ③ White 60% remission factor
- ④ Black 9.5% remission factor
- ⑤ Stainless steel

Recommended accessories

Other models and accessories → www.sick.com/OD2000

	Brief description	Type	Part no.
Connection modules			
	IO-Link V1.1 Class A port, USB2.0 port, optional external power supply 24V / 1A	IOLA2US-01101 (SiLink2 Master)	1061790
Mounting brackets and plates			
	Stainless-steel mounting bracket, stainless steel	BEF-WN-OD2000	4112929
	<ul style="list-style-type: none"> • Connection type head A: Female connector, M12, 5-pin, straight, A-coded • Connection type head B: Flying leads • Signal type: Sensor/actuator cable • Cable: 2 m, 5-wire, PVC • Description: Sensor/actuator cable, unshielded • Application: Zones with chemicals 	YF2A15-020VB5XLEAX	2096239

SICK AT A GLANCE

SICK is one of the leading manufacturers of intelligent sensors and sensor solutions for industrial applications. A unique range of products and services creates the perfect basis for controlling processes securely and efficiently, protecting individuals from accidents and preventing damage to the environment.

We have extensive experience in a wide range of industries and understand their processes and requirements. With intelligent sensors, we can deliver exactly what our customers need. In application centers in Europe, Asia and North America, system solutions are tested and optimized in accordance with customer specifications. All this makes us a reliable supplier and development partner.

Comprehensive services complete our offering: SICK LifeTime Services provide support throughout the machine life cycle and ensure safety and productivity.

For us, that is “Sensor Intelligence.”

WORLDWIDE PRESENCE:

Contacts and other locations –www.sick.com