



OD2-P300W200I0

OD Value

DISPLACEMENT MEASUREMENT SENSORS

SICK
Sensor Intelligence.



Illustration may differ



Ordering information

Type	Part no.
OD2-P300W200IO	6048912

Other models and accessories → www.sick.com/OD_Value

Detailed technical data

Features

Measuring range	100 mm ... 500 mm ¹⁾
Target	Natural objects
Repeatability	100 µm ^{2) 3) 4)}
Linearity	± 1,200 µm ^{2) 3) 5)}
Response time	≥ 1 ms
Output time	≥ 0.75 ms
Light source	Laser, red visible red light
Type of light	Visible red light
Laser class	2 (IEC 60825-1:2014, EN 60825-1:2014) ⁶⁾
Typ. light spot size (distance)	1.9 mm x 3.9 mm (300 mm)
Additional function	Mean-value setting 1 ... 64x Automatic sensitivity adjustment Analog outputs can be taught in Invertable analog output Teach-in of digital output Invertable switching output Multifunctional input: laser-off / external teach-in / trigger Switching mode: distance to object (DtO) Switching mode: window (Wnd)
Safety-related parameters	
	MTTF _D 101 years
	DC _{avg} 0%

¹⁾ 6% ... 90% remission factor.

²⁾ Measurement on 90 % remission (ceramic, white).

³⁾ At averaging function medium.

⁴⁾ Constant ambient conditions.

⁵⁾ When calibrated in the application regularly.

⁶⁾ Wavelength: 655 nm, max. output: 1 mW.

Interfaces

Digital output	Number	2 ¹⁾
	Type	PNP
	Maximum output current I_A	≤ 100 mA
Analog output	Number	1
	Type	Current output
	Current	4 mA ... 20 mA, $\leq 300 \Omega$
	Resolution	16 bit
Multifunctional input (MF)		1 x MF ²⁾

¹⁾ PNP: HIGH = $V_S - (< 2 V)$ / LOW = $< 2 V$; NPN: HIGH = $< 2 V$ / LOW = V_S .

²⁾ MF can be used as laser-off, trigger, external teach-in, or deactivated; response time ≤ 3 ms.

Electronics

Supply voltage U_B	DC 12 V ... 24 V
Power consumption	≤ 2.88 W ¹⁾
Warm-up time	≤ 30 min
Indication	Distance bar graph, up to 8 status LEDs
Enclosure rating	IP67
Protection class	III

¹⁾ Without load, with current output.

Mechanics

Dimensions (W x H x D)	20.4 mm x 60 mm x 50 mm
Housing material	Plastic (PBT)
Window material	Plastic (PMMA)
Weight	70 g
Connection type	Male connector, M12, 8-pin, swivel connector unit

Ambient data

Ambient temperature, operation	$-10 \text{ }^\circ\text{C} \dots +40 \text{ }^\circ\text{C}$
Ambient temperature, storage	$-20 \text{ }^\circ\text{C} \dots +60 \text{ }^\circ\text{C}$
Relative air humidity (non-condensing)	35 % ... 95 %
Temperature drift	± 0.08 % FS/K (FS = Full Scale = Measuring range of sensor)
Typ. Ambient light immunity	Artificial light: $\leq 3,000$ lx Sunlight: $\leq 10,000$ lx
Vibration resistance	10 Hz ... 55 Hz (amplitude 1.5 mm, x-, y-, z-axis 2 hours each)
Shock resistance	50 G (x, y, z axis 3 times each)

Classifications

ECLASS 5.0	27270801
ECLASS 5.1.4	27270801
ECLASS 6.0	27270801
ECLASS 6.2	27270801

OD2-P300W200I0 | OD Value

DISPLACEMENT MEASUREMENT SENSORS

ECLASS 7.0	27270801
ECLASS 8.0	27270801
ECLASS 8.1	27270801
ECLASS 9.0	27270801
ECLASS 10.0	27270801
ECLASS 11.0	27270801
ECLASS 12.0	27270916
ETIM 5.0	EC001825
ETIM 6.0	EC001825
ETIM 7.0	EC001825
ETIM 8.0	EC001825
UNSPSC 16.0901	41111613

Dimensional drawing (Dimensions in mm (inch))

OD2-x300W200xx

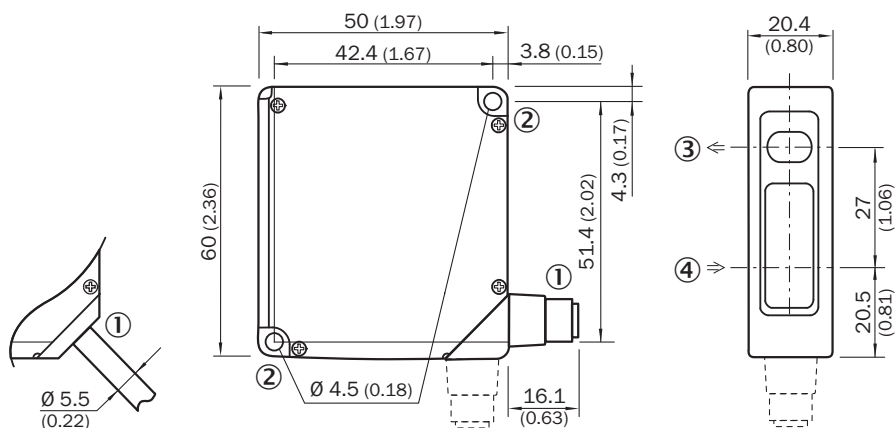

- ① 2 m cable or M12 connector; 90° rotatable
- ② Mounting hole, Ø 4.5 mm
- ③ Optical axis, sender
- ④ Optical axis, receiver

Connection type

OD2-xxxxxA0 OD2-xxxxxC0 OD2-xxxxxI0 OD2-xxxxxU0 connector M12, 8-pin

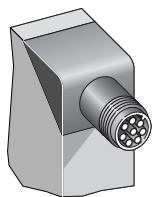

Connection diagram

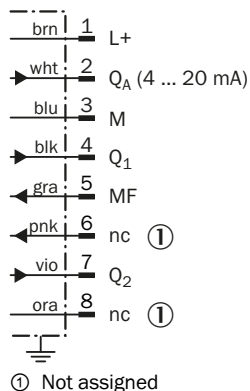

Adjustment possible

OD2-xxxxxIx

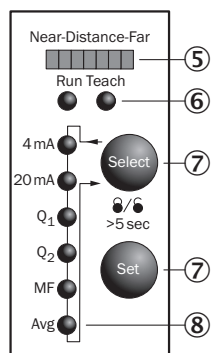

- ⑤ Distance indicator
- ⑥ Mode indicator (Run/Teach)
- ⑦ Control elements
- ⑧ Status indicator in- and outputs (Run-mode)/menu indicator (Teach-mode)

Light spot size

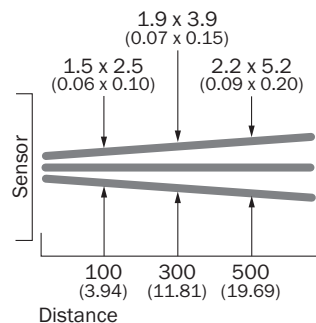

All dimensions in mm (inch)

Linearity

OD2-x300xxxx

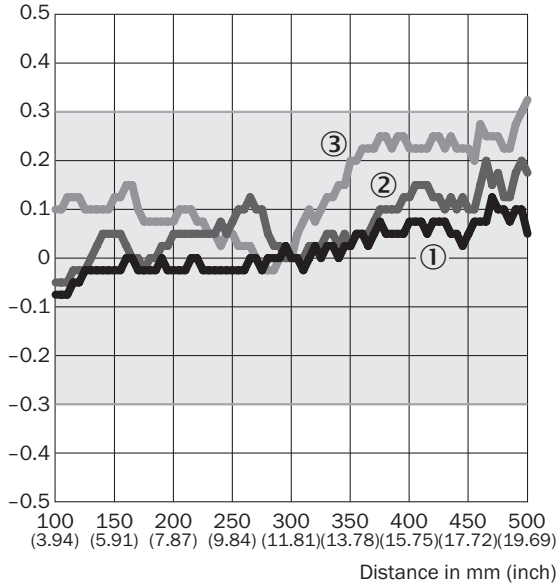

Linearity [%FS]



- ① White ceramic
- ② Black paper
- ③ Stainless steel

Recommended accessories

Other models and accessories → www.sick.com/OD_Value

	Brief description	Type	Part no.
Mounting brackets and plates			
	Stainless-steel mounting bracket, stainless steel	BEF-WN-OD1000	4089813
Others			
	<ul style="list-style-type: none"> • Connection type head A: Female connector, M12, 8-pin, straight • Connection type head B: Flying leads • Signal type: Sensor/actuator cable • Cable: 2 m, 8-wire, PVC • Description: Sensor/actuator cable, special color code, shielded • Connection systems: Flying leads 	DOL-1208-G02MF	6020663

Recommended services

Additional services → www.sick.com/OD_Value

	Type	Part no.
Commissioning		
<ul style="list-style-type: none"> • Product area: Displacement measurement sensors • Range of services: Inspection of connection and mounting, optimization of parameters of SICK product as well as tests, set-up of previously defined functions of the scaling of the analog measuring range, switching point position, hysteresis, measuring frequency, measured value filter, signal quality, evaluation function, or communication interface • Travel expenses: The prices do not include travel costs such as hotel, flight, travel time and expenses. • Duration: Additional work will be invoiced separately 	DT20 Hi/OD/OL commissioning	1612241

SICK AT A GLANCE

SICK is one of the leading manufacturers of intelligent sensors and sensor solutions for industrial applications. A unique range of products and services creates the perfect basis for controlling processes securely and efficiently, protecting individuals from accidents and preventing damage to the environment.

We have extensive experience in a wide range of industries and understand their processes and requirements. With intelligent sensors, we can deliver exactly what our customers need. In application centers in Europe, Asia and North America, system solutions are tested and optimized in accordance with customer specifications. All this makes us a reliable supplier and development partner.

Comprehensive services complete our offering: SICK LifeTime Services provide support throughout the machine life cycle and ensure safety and productivity.

For us, that is “Sensor Intelligence.”

WORLDWIDE PRESENCE:

Contacts and other locations –www.sick.com