



# OD2-P85W20I2

OD Value

DISPLACEMENT MEASUREMENT SENSORS

**SICK**  
Sensor Intelligence.



Illustration may differ



### Ordering information

Type	Part no.
OD2-P85W2012	6036609

Other models and accessories → [www.sick.com/OD\\_Value](http://www.sick.com/OD_Value)

### Detailed technical data

#### Features

<b>Measuring range</b>	65 mm ... 105 mm <sup>1)</sup>
<b>Target</b>	Natural objects
<b>Repeatability</b>	10 µm <sup>1) 2) 3)</sup>
<b>Linearity</b>	± 40 µm <sup>2) 4) 5)</sup>
<b>Response time</b>	≥ 1 ms
<b>Output time</b>	≥ 0.5 ms
<b>Light source</b>	Laser, red visible red light
<b>Type of light</b>	Visible red light
<b>Laser class</b>	2 (IEC 60825-1:2014, EN 60825-1:2014) <sup>6)</sup>
<b>Typ. light spot size (distance)</b>	0.8 mm x 1.3 mm (85 mm)
<b>Additional function</b>	Mean-value setting 1 ... 64x Automatic sensitivity adjustment Analog outputs can be taught in Invertable analog output Teach-in of digital output Invertable switching output Multifunctional input: laser-off / external teach-in / trigger Switching mode: distance to object (DtO) Switching mode: window (Wnd)
<b>Safety-related parameters</b>	
	MTTF <sub>D</sub> 101 years
	DC <sub>avg</sub> 0%

<sup>1)</sup> 6% ... 90% remission factor.

<sup>2)</sup> At averaging function medium.

<sup>3)</sup> Constant ambient conditions.

<sup>4)</sup> Measurement on 90 % remission (ceramic, white).

<sup>5)</sup> When calibrated in the application regularly.

<sup>6)</sup> Wavelength: 655 nm, max. output: 1 mW.

## Interfaces

<b>Digital output</b>	Number	2 <sup>1)</sup>
	Type	PNP
	Maximum output current $I_A$	$\leq 100$ mA
<b>Analog output</b>	Number	1
	Type	Current output
	Current	4 mA ... 20 mA, $\leq 300 \Omega$
	Resolution	16 bit
<b>Multifunctional input (MF)</b>		1 x MF <sup>2)</sup>

<sup>1)</sup> PNP: HIGH =  $V_S - (< 2 V)$  / LOW =  $< 2 V$ ; NPN: HIGH =  $< 2 V$  / LOW =  $V_S$ .

<sup>2)</sup> MF can be used as laser-off, trigger, external teach-in, or deactivated; response time  $\leq 3$  ms.

## Electronics

<b>Supply voltage <math>U_B</math></b>	DC 12 V ... 24 V
<b>Power consumption</b>	$\leq 2.88$ W <sup>1)</sup>
<b>Warm-up time</b>	$\leq 30$ min
<b>Indication</b>	Distance bar graph, up to 8 status LEDs
<b>Enclosure rating</b>	IP67
<b>Protection class</b>	III

<sup>1)</sup> Without load, with current output.

## Mechanics

<b>Dimensions (W x H x D)</b>	20.4 mm x 60 mm x 50 mm
<b>Housing material</b>	Plastic (PBT)
<b>Window material</b>	Plastic (PMMA)
<b>Weight</b>	70 g
<b>Connection type</b>	Cable, 2 m

## Ambient data

<b>Ambient temperature, operation</b>	-10 °C ... +40 °C
<b>Ambient temperature, storage</b>	-20 °C ... +60 °C
<b>Relative air humidity (non-condensing)</b>	35 % ... 95 %
<b>Temperature drift</b>	$\pm 0.08$ % FS/K (FS = Full Scale = Measuring range of sensor)
<b>Typ. Ambient light immunity</b>	Artificial light: $\leq 3,000$ lx Sunlight: $\leq 10,000$ lx
<b>Vibration resistance</b>	10 Hz ... 55 Hz (amplitude 1.5 mm, x-, y-, z-axis 2 hours each)
<b>Shock resistance</b>	50 G (x, y, z axis 3 times each)

## Classifications

<b>ECLASS 5.0</b>	27270801
<b>ECLASS 5.1.4</b>	27270801
<b>ECLASS 6.0</b>	27270801
<b>ECLASS 6.2</b>	27270801

# OD2-P85W2012 | OD Value

## DISPLACEMENT MEASUREMENT SENSORS

<b>ECLASS 7.0</b>	27270801
<b>ECLASS 8.0</b>	27270801
<b>ECLASS 8.1</b>	27270801
<b>ECLASS 9.0</b>	27270801
<b>ECLASS 10.0</b>	27270801
<b>ECLASS 11.0</b>	27270801
<b>ECLASS 12.0</b>	27270916
<b>ETIM 5.0</b>	EC001825
<b>ETIM 6.0</b>	EC001825
<b>ETIM 7.0</b>	EC001825
<b>ETIM 8.0</b>	EC001825
<b>UNSPSC 16.0901</b>	41111613

### Dimensional drawing (Dimensions in mm (inch))

OD2-x85W20xx

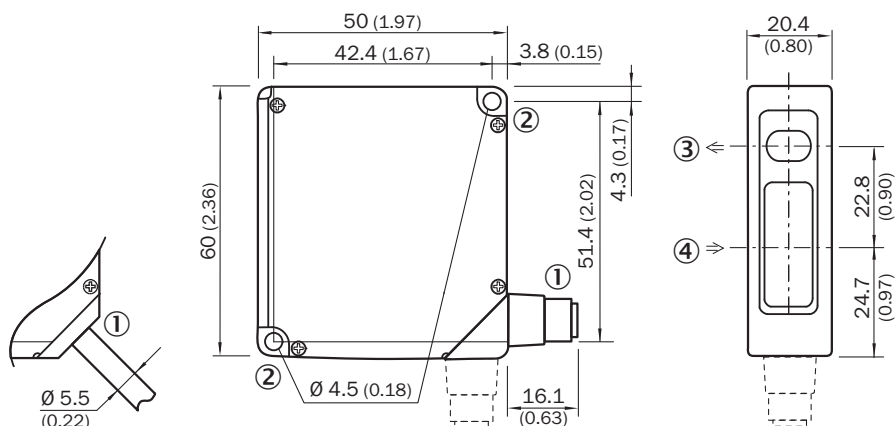

- ① 2 m cable or M12 connector; 90° rotatable
- ② Mounting hole, Ø 4.5 mm
- ③ Optical axis, sender
- ④ Optical axis, receiver

### Connection type

OD2-xxxxxA2 OD2-xxxxxC2 OD2-xxxxxI2 OD2-xxxxxU2 cable

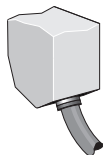

### Connection diagram

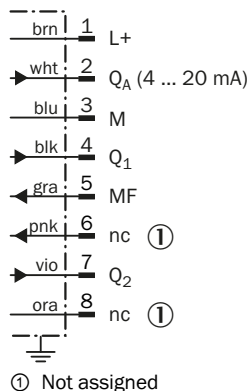

### Adjustment possible

OD2-xxxxxxIx

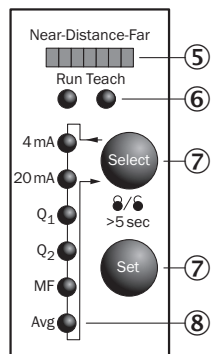

- ⑤ Distance indicator
- ⑥ Mode indicator (Run/Teach)
- ⑦ Control elements
- ⑧ Status indicator in- and outputs (Run-mode)/menu indicator (Teach-mode)

### Light spot size

OD2-x85W20xx

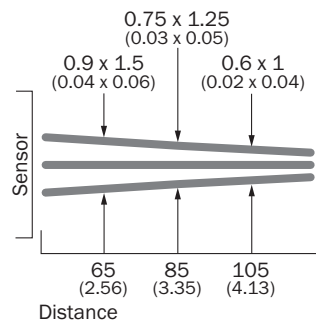

All dimensions in mm (inch)

### Linearity

OD2-x85xxxxx

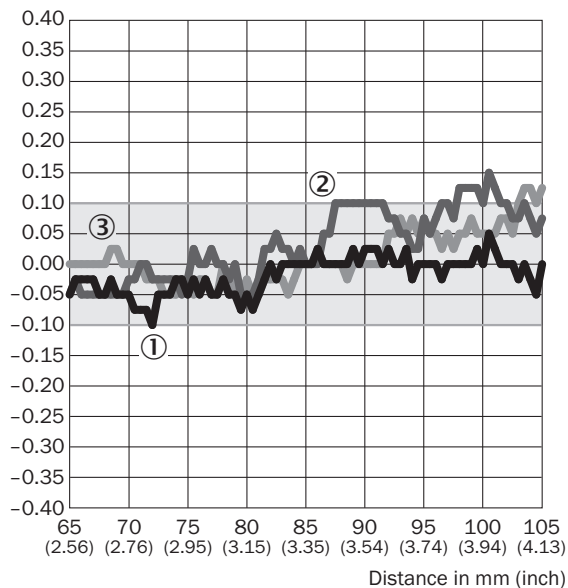

Linearity [%FS]



- ① White ceramic
- ② Black paper
- ③ Stainless steel

### Recommended accessories

Other models and accessories → [www.sick.com/OD\\_Value](http://www.sick.com/OD_Value)

	Brief description	Type	Part no.
<b>Mounting brackets and plates</b>			
	Stainless-steel mounting bracket, stainless steel	BEF-WN-OD1000	4089813
<b>Others</b>			
	<ul style="list-style-type: none"> <li>• <b>Connection type head A:</b> Female connector, M12, 8-pin, straight</li> <li>• <b>Connection type head B:</b> Flying leads</li> <li>• <b>Signal type:</b> Sensor/actuator cable</li> <li>• <b>Cable:</b> 2 m, 8-wire, PVC</li> <li>• <b>Description:</b> Sensor/actuator cable, special color code, shielded</li> <li>• <b>Connection systems:</b> Flying leads</li> </ul>	DOL-1208-G02MF	6020663

### Recommended services

Additional services → [www.sick.com/OD\\_Value](http://www.sick.com/OD_Value)

	Type	Part no.
Commissioning		
<ul style="list-style-type: none"> <li>• <b>Product area:</b> Displacement measurement sensors</li> <li>• <b>Range of services:</b> Inspection of connection and mounting, optimization of parameters of SICK product as well as tests, set-up of previously defined functions of the scaling of the analog measuring range, switching point position, hysteresis, measuring frequency, measured value filter, signal quality, evaluation function, or communication interface</li> <li>• <b>Travel expenses:</b> The prices do not include travel costs such as hotel, flight, travel time and expenses.</li> <li>• <b>Duration:</b> Additional work will be invoiced separately</li> </ul>	DT20 Hi/OD/OL commissioning	1612241

## SICK AT A GLANCE

SICK is one of the leading manufacturers of intelligent sensors and sensor solutions for industrial applications. A unique range of products and services creates the perfect basis for controlling processes securely and efficiently, protecting individuals from accidents and preventing damage to the environment.

We have extensive experience in a wide range of industries and understand their processes and requirements. With intelligent sensors, we can deliver exactly what our customers need. In application centers in Europe, Asia and North America, system solutions are tested and optimized in accordance with customer specifications. All this makes us a reliable supplier and development partner.

Comprehensive services complete our offering: SICK LifeTime Services provide support throughout the machine life cycle and ensure safety and productivity.

For us, that is “Sensor Intelligence.”

## WORLDWIDE PRESENCE:

Contacts and other locations –[www.sick.com](http://www.sick.com)