

OD5-25T01

OD Precision

DISPLACEMENT MEASUREMENT SENSORS

SICK
Sensor Intelligence.



Ordering information

Type	Part no.
OD5-25T01	6035975

Other models and accessories → www.sick.com/OD_Precision



Detailed technical data

Features

System part	Sensor head
Measuring range	24 mm ... 26 mm ¹⁾
Target	Natural objects
Repeatability	0.02 μm ²⁾
Linearity	± 1.6 μm ²⁾
Response time	≥ 0.1 ms ^{3) 4)}
Output time	≥ 0.1 ms
Light source	Laser, red visible red light
Type of light	Visible red light
Laser class	1 (IEC 60825-1:2014, EN 60825-1:2014) ⁵⁾
Typ. light spot size (distance)	25 μm x 35 μm (25 mm)
Special task	Thickness measurement of transparent material
Additional function	Mean-value setting 1 ... 4,096x Selectable measuring frequency (automatic / 0.1 ms ... 3.2 ms) Automatic sensitivity adjustment Manual sensitivity adjustment Mutual interference Glass thickness measurement
Thickness measurement of transparent material	0.2 mm ... 2 mm
General notes	Note on use OD Precision sensor head can be used in combination with AOD5-P/N1 or stand-alone via RS-422
Safety-related parameters	MTTF _D 101 years DC _{avg} 0%

¹⁾ 6 % ... 90 % remission; at default settings.

²⁾ Measurement at 90% remission (ceramic, white), or mirror for OD5-25x; averaging set to: 256 or 4096 for OD5-25x; constant ambient conditions.

³⁾ Time needed for automatic sensitivity adjustment is calculated as: sampling period x 20. At default setting 100 μs (10kHz) this is ≤ 2ms.

⁴⁾ Default setting for OD5-350x100 and OD5-500x200 = 0.8 ms, or 1.25 kHz, all others = 0.1 ms/10 kHz.

⁵⁾ Wavelength: 650 nm, max. output: 390 μW.

Interfaces

Serial	✓, RS-422
Remark	RS-232 optional via external evaluation unit AOD5
Digital output	
Number	5 ¹⁾
Type	PNP / NPN
Maximum output current I _A	≤ 100 mA
Analog output	
Number	3 ^{1) 2)}
Type	Current output / voltage output
Current	4 mA ... 20 mA, ≤ 300 Ω
Voltage	0 V ... 10 V ³⁾
Laser-off input	1 x laser-off

¹⁾ Optional over evaluation unit AOD5.

²⁾ A maximum of three current and three voltage outputs are possible via the AOD5 evaluation unit.

³⁾ Output resistance 100 Ω, min. load 10 k Ω.

Electronics

Supply voltage U_B	DC 12 V ... 24 V ¹⁾
Warm-up time	≤ 5 min
Indication	LEDs, 4" color display on optional evaluation unit
Enclosure rating	IP67
Protection class	III

¹⁾ DC 12 V (-5 %) ... DC 24 V (+10 %).

Mechanics

Dimensions (W x H x D)	29 mm x 78 mm x 75 mm
Housing material	Metal (Aluminum)
Window material	Glass
Weight	250 g ¹⁾
Connection type	0.5 m cable with connector ²⁾

¹⁾ Includes 0.5 m cable.

²⁾ Can be extended to up to 50 m with extension cable.

Ambient data

Ambient temperature, operation	-10 °C ... +50 °C
Ambient temperature, storage	-20 °C ... +60 °C
Relative air humidity (non-condensing)	35 % ... 85 %
Temperature drift	± 0.01 % FS/K (FS = Full Scale = Measuring range of sensor)
Typ. Ambient light immunity	Artificial light: ≤ 3,000 lx Sunlight: ≤ 10,000 lx
Vibration resistance	10 Hz ... 55 Hz (amplitude 1.5 mm, x-, y-, z-axis 2 hours each)
Shock resistance	50 G (x, y, z axis 3 times each)

Classifications

ECLASS 5.0	27270801
ECLASS 5.1.4	27270801
ECLASS 6.0	27270801
ECLASS 6.2	27270801
ECLASS 7.0	27270801
ECLASS 8.0	27270801
ECLASS 8.1	27270801
ECLASS 9.0	27270801
ECLASS 10.0	27270801
ECLASS 11.0	27270801
ECLASS 12.0	27270916
ETIM 5.0	EC001825
ETIM 6.0	EC001825
ETIM 7.0	EC001825
ETIM 8.0	EC001825
UNSPSC 16.0901	411111613

Dimensional drawing (Dimensions in mm (inch))

OD5-25xxx

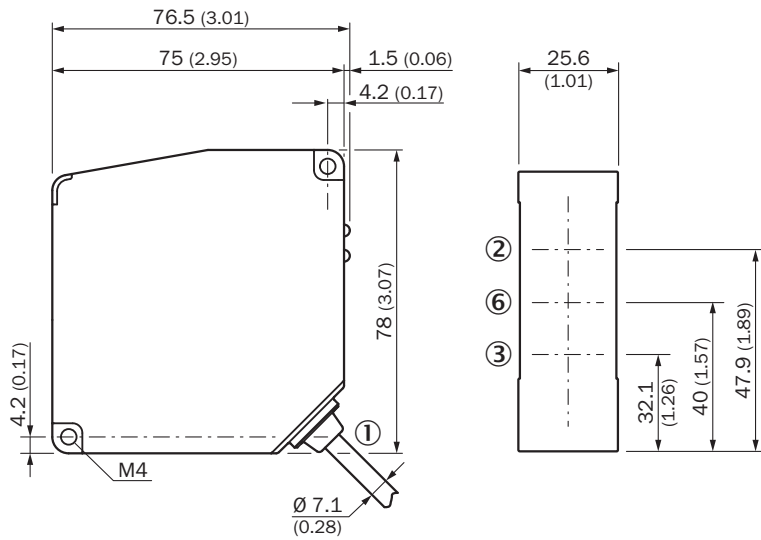

- ① Cable Ø 7.1 mm, 0.5 m with connector, 12-pin
- ② Optical axis, receiver
- ③ Optical axis, sender
- ⑥ Optical axis, light spot (at 25 mm due to V-Optics with 17.5°)

Connection type

Hirose 12-pin male connector for sensor head



Connection diagram

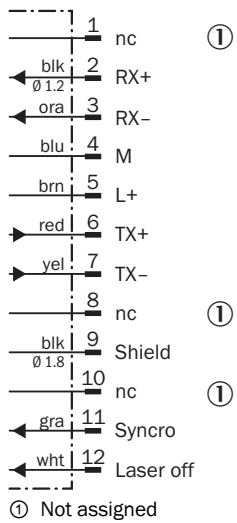

Adjustment possible

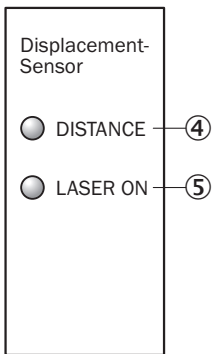

- ④ Distance indicator
- ⑤ Status indicator laser (laser on)

Light spot size

OD5-25T01

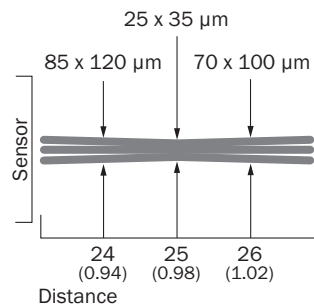

All dimensions in mm (inch)

Linearity

OD5-25T01

Linearity [%FS]

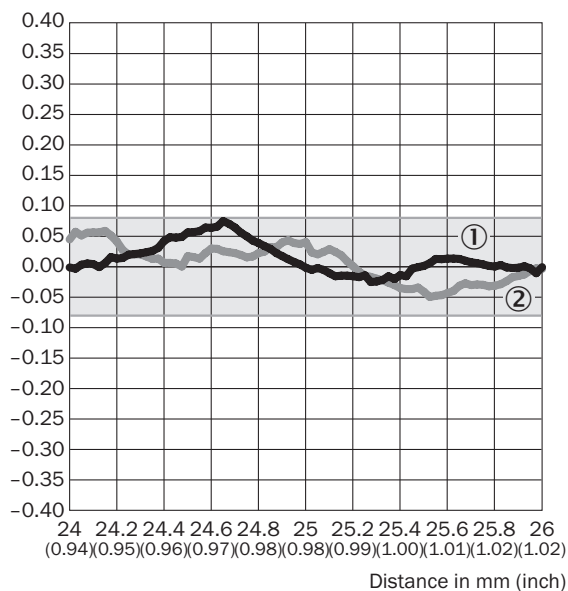





- ① Mirror
- ② Stone, ceramic, glass

Recommended accessories

Other models and accessories → www.sick.com/OD_Precision

	Brief description	Type	Part no.
Evaluation units			
	Evaluation unit: OD Precision, 5 x NPN	AOD5-N1	6035984
	Evaluation unit: OD Precision, 5 x PNP	AOD5-P1	6035985

	Brief description	Type	Part no.
	<ul style="list-style-type: none"> • Connection type head A: Female connector, M12, 12-pin, straight • Connection type head B: Male connector, M12, 12-pin, straight • Signal type: RS-422 • Cable: 2 m, 12-wire, twisted pair, PVC • Description: RS-422, shielded • Note: OD Precision specific 	YFHRSB-020XXXMHRB	6035986
	<ul style="list-style-type: none"> • Connection type head A: Female connector, M12, 12-pin, straight • Connection type head B: Flying leads • Cable: 5 m, 12-wire, PVC • Description: Shielded • Note: For stand-alone operation 	DOL-1212-G05M	6035988
	<ul style="list-style-type: none"> • Connection type head A: Female connector, M12, 12-pin, straight • Connection type head B: Male connector, M12, 12-pin, straight • Signal type: RS-422 • Cable: 5 m, 12-wire, twisted pair, PVC • Description: RS-422, shielded • Note: OD Precision specific 	YFHRSB-050XXXMHRB	6035987
	<ul style="list-style-type: none"> • Connection type head A: Male connector, 50-pin, straight • Connection type head B: Flying leads • Cable: 3 m, 50-wire, PVC • Description: Shielded • Connection systems: Flying leads • Note: In- and output expansion cable for AOD5-P/N1 (OD Precision) 	IO-EXP-AOD5	6035990
	<ul style="list-style-type: none"> • Connection type head A: Male connector, 12-pin • Connection type head B: Terminal connector, 12-pin • Description: Unshielded • Connection systems: Spring terminal • Note: Terminal strip for AOD5-P/N1 (OD Precision) 	TERM.-AOD5	6035989

Recommended services

Additional services → www.sick.com/OD_Precision

	Type	Part no.
Commissioning		
<ul style="list-style-type: none"> • Product area: Displacement measurement sensors • Range of services: Inspection of connection and mounting, optimization of parameters of SICK product as well as tests, set-up of previously defined functions of the scaling of the analog measuring range, switching point position, hysteresis, measuring frequency, measured value filter, signal quality, evaluation function, or communication interface • Travel expenses: The prices do not include travel costs such as hotel, flight, travel time and expenses. • Duration: Additional work will be invoiced separately 	DT20 Hi/OD/OL commissioning	1612241

SICK AT A GLANCE

SICK is one of the leading manufacturers of intelligent sensors and sensor solutions for industrial applications. A unique range of products and services creates the perfect basis for controlling processes securely and efficiently, protecting individuals from accidents and preventing damage to the environment.

We have extensive experience in a wide range of industries and understand their processes and requirements. With intelligent sensors, we can deliver exactly what our customers need. In application centers in Europe, Asia and North America, system solutions are tested and optimized in accordance with customer specifications. All this makes us a reliable supplier and development partner.

Comprehensive services complete our offering: SICK LifeTime Services provide support throughout the machine life cycle and ensure safety and productivity.

For us, that is “Sensor Intelligence.”

WORLDWIDE PRESENCE:

Contacts and other locations –www.sick.com