

# OD5-85W20

OD Precision

DISPLACEMENT MEASUREMENT SENSORS

**SICK**  
Sensor Intelligence.



### Ordering information

Type	Part no.
OD5-85W20	6035980

Other models and accessories → [www.sick.com/OD\\_Precision](http://www.sick.com/OD_Precision)



### Detailed technical data

#### Features

<b>System part</b>	Sensor head
<b>Measuring range</b>	65 mm ... 105 mm <sup>1) 2)</sup>
<b>Target</b>	Natural objects
<b>Repeatability</b>	1 µm <sup>3)</sup>
<b>Linearity</b>	Diffuse ± 20 µm <sup>3)</sup> Specular ± 16 µm <sup>3)</sup>
<b>Response time</b>	≥ 0.1 ms <sup>4) 5)</sup>
<b>Output time</b>	≥ 0.1 ms
<b>Light source</b>	Laser, red visible red light
<b>Type of light</b>	Visible red light
<b>Laser class</b>	2 (IEC 60825-1:2014, EN 60825-1:2014) <sup>6)</sup>
<b>Typ. light spot size (distance)</b>	260 µm x 1,200 µm (85 mm)
<b>Special task</b>	Thickness measurement of transparent material
<b>Additional function</b>	Mean-value setting 1 ... 4,096x Selectable measuring frequency (automatic / 0.1 ms ... 3.2 ms) Automatic sensitivity adjustment Manual sensitivity adjustment Mutual interference Glass thickness measurement
<b>Thickness measurement of transparent material</b>	2 mm ... 20 mm
<b>General notes</b>	Note on use OD Precision sensor head can be used in combination with AOD5-P/N1 or stand-alone via RS-422
<b>Safety-related parameters</b>	MTTF <sub>D</sub> 101 years DC <sub>avg</sub> 0%

<sup>1)</sup> 6 % ... 90 % remission; at default settings.

<sup>2)</sup> If there are reflections, the measuring range is reduced to 72.3 mm ... 92.3 mm.

<sup>3)</sup> Measurement at 90% remission (ceramic, white), or mirror for OD5-25x; averaging set to: 256 or 4096 for OD5-25x; constant ambient conditions.

<sup>4)</sup> Time needed for automatic sensitivity adjustment is calculated as: sampling period x 20. At default setting 100 µs (10kHz) this is ≤ 2ms.

<sup>5)</sup> Default setting for OD5-350x100 and OD5-500x200 = 0.8 ms, or 1.25 kHz, all others = 0.1 ms/10 kHz.

<sup>6)</sup> Wavelength: 658 nm, max. output: 1 mW.

## Interfaces

<b>Serial</b>	✓, RS-422
Remark	RS-232 optional via external evaluation unit AOD5
<b>Digital output</b>	
Number	5 <sup>1)</sup>
Type	PNP / NPN
Maximum output current $I_A$	≤ 100 mA
<b>Analog output</b>	
Number	3 <sup>1) 2)</sup>
Type	Current output / voltage output
Current	4 mA ... 20 mA, ≤ 300 Ω
Voltage	0 V ... 10 V <sup>3)</sup>
<b>Laser-off input</b>	1 x laser-off

<sup>1)</sup> Optional over evaluation unit AOD5.

<sup>2)</sup> A maximum of three current and three voltage outputs are possible via the AOD5 evaluation unit.

<sup>3)</sup> Output resistance 100 Ω, min. load 10 k Ω.

## Electronics

<b>Supply voltage <math>U_B</math></b>	DC 12 V ... 24 V <sup>1)</sup>
<b>Warm-up time</b>	≤ 5 min
<b>Indication</b>	LEDs, 4" color display on optional evaluation unit
<b>Enclosure rating</b>	IP67
<b>Protection class</b>	III

<sup>1)</sup> DC 12 V (-5 %) ... DC 24 V (+10 %).

## Mechanics

<b>Dimensions (W x H x D)</b>	29 mm x 78 mm x 75 mm
<b>Housing material</b>	Metal (Aluminum)
<b>Window material</b>	Glass
<b>Weight</b>	250 g <sup>1)</sup>
<b>Connection type</b>	0.5 m cable with connector <sup>2)</sup>

<sup>1)</sup> Includes 0.5 m cable.

<sup>2)</sup> Can be extended to up to 50 m with extension cable.

## Ambient data

<b>Ambient temperature, operation</b>	-10 °C ... +50 °C
<b>Ambient temperature, storage</b>	-20 °C ... +60 °C
<b>Relative air humidity (non-condensing)</b>	35 % ... 85 %
<b>Temperature drift</b>	± 0.01 % FS/K (FS = Full Scale = Measuring range of sensor)
<b>Typ. Ambient light immunity</b>	Artificial light: ≤ 3,000 lx Sunlight: ≤ 10,000 lx
<b>Vibration resistance</b>	10 Hz ... 55 Hz (amplitude 1.5 mm, x-, y-, z-axis 2 hours each)
<b>Shock resistance</b>	50 G (x, y, z axis 3 times each)

Classifications

<b>ECLASS 5.0</b>	27270801
<b>ECLASS 5.1.4</b>	27270801
<b>ECLASS 6.0</b>	27270801
<b>ECLASS 6.2</b>	27270801
<b>ECLASS 7.0</b>	27270801
<b>ECLASS 8.0</b>	27270801
<b>ECLASS 8.1</b>	27270801
<b>ECLASS 9.0</b>	27270801
<b>ECLASS 10.0</b>	27270801
<b>ECLASS 11.0</b>	27270801
<b>ECLASS 12.0</b>	27270916
<b>ETIM 5.0</b>	EC001825
<b>ETIM 6.0</b>	EC001825
<b>ETIM 7.0</b>	EC001825
<b>ETIM 8.0</b>	EC001825
<b>UNSPSC 16.0901</b>	411111613

Dimensional drawing (Dimensions in mm (inch))

OD5-85xxx

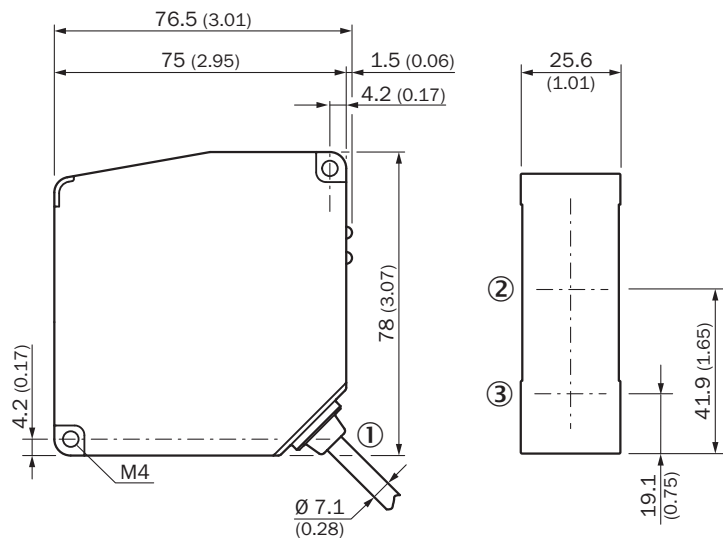

- ① Cable Ø 7.1 mm, 0.5 m with connector, 12-pin
- ② Optical axis, receiver
- ③ Optical axis, sender

## Connection type

Hirose 12-pin male connector for sensor head



## Connection diagram

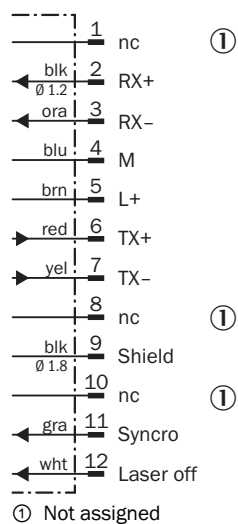

## Adjustment possible

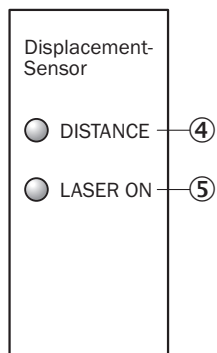

- ④ Distance indicator
- ⑤ Status indicator laser (laser on)

Light spot size

OD5-85W20

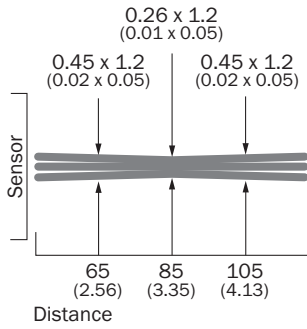

All dimensions in mm (inch)

Linearity

OD5-85W20



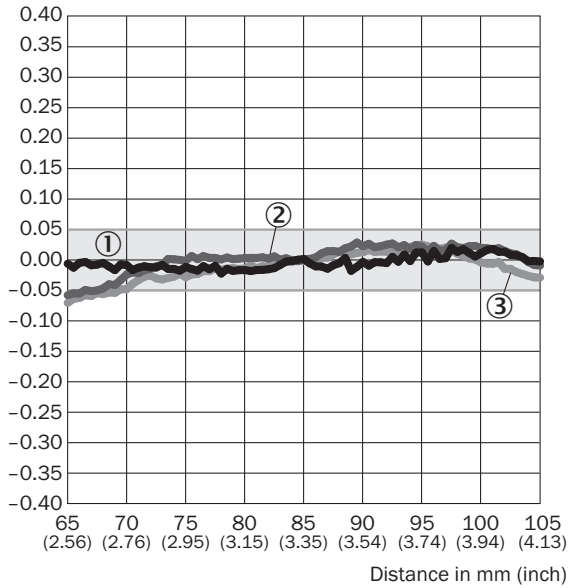



Linearity [%FS]



- ① White ceramic
- ② Stainless steel
- ③ Black rubber

## Recommended accessories

Other models and accessories → [www.sick.com/OD\\_Precision](http://www.sick.com/OD_Precision)

	Brief description	Type	Part no.
Evaluation units			
	Evaluation unit: OD Precision, 5 x NPN	AOD5-N1	6035984
	Evaluation unit: OD Precision, 5 x PNP	AOD5-P1	6035985
	<ul style="list-style-type: none"> <li><b>Connection type head A:</b> Female connector, M12, 12-pin, straight</li> <li><b>Connection type head B:</b> Male connector, M12, 12-pin, straight</li> <li><b>Signal type:</b> RS-422</li> <li><b>Cable:</b> 2 m, 12-wire, twisted pair, PVC</li> <li><b>Description:</b> RS-422, shielded</li> <li><b>Note:</b> OD Precision specific</li> </ul>	YFHRSB-020XXXMHRSB	6035986
	<ul style="list-style-type: none"> <li><b>Connection type head A:</b> Female connector, M12, 12-pin, straight</li> <li><b>Connection type head B:</b> Flying leads</li> <li><b>Cable:</b> 5 m, 12-wire, PVC</li> <li><b>Description:</b> Shielded</li> <li><b>Note:</b> For stand-alone operation</li> </ul>	D0L-1212-G05M	6035988
	<ul style="list-style-type: none"> <li><b>Connection type head A:</b> Female connector, M12, 12-pin, straight</li> <li><b>Connection type head B:</b> Male connector, M12, 12-pin, straight</li> <li><b>Signal type:</b> RS-422</li> <li><b>Cable:</b> 5 m, 12-wire, twisted pair, PVC</li> <li><b>Description:</b> RS-422, shielded</li> <li><b>Note:</b> OD Precision specific</li> </ul>	YFHRSB-050XXXMHRSB	6035987
	<ul style="list-style-type: none"> <li><b>Connection type head A:</b> Male connector, 50-pin, straight</li> <li><b>Connection type head B:</b> Flying leads</li> <li><b>Cable:</b> 3 m, 50-wire, PVC</li> <li><b>Description:</b> Shielded</li> <li><b>Connection systems:</b> Flying leads</li> <li><b>Note:</b> In- and output expansion cable for AOD5-P/N1 (OD Precision)</li> </ul>	IO-EXP-AOD5	6035990
	<ul style="list-style-type: none"> <li><b>Connection type head A:</b> Male connector, 12-pin</li> <li><b>Connection type head B:</b> Terminal connector, 12-pin</li> <li><b>Description:</b> Unshielded</li> <li><b>Connection systems:</b> Spring terminal</li> <li><b>Note:</b> Terminal strip for AOD5-P/N1 (OD Precision)</li> </ul>	TERM.-AOD5	6035989

## Recommended services

Additional services → [www.sick.com/OD\\_Precision](http://www.sick.com/OD_Precision)

	Type	Part no.
Commissioning		
<ul style="list-style-type: none"> <li><b>Product area:</b> Displacement measurement sensors</li> <li><b>Range of services:</b> Inspection of connection and mounting, optimization of parameters of SICK product as well as tests, set-up of previously defined functions of the scaling of the analog measuring range, switching point position, hysteresis, measuring frequency, measured value filter, signal quality, evaluation function, or communication interface</li> <li><b>Travel expenses:</b> The prices do not include travel costs such as hotel, flight, travel time and expenses.</li> <li><b>Duration:</b> Additional work will be invoiced separately</li> </ul>	DT20 Hi/OD/OL commissioning	1612241

## SICK AT A GLANCE

SICK is one of the leading manufacturers of intelligent sensors and sensor solutions for industrial applications. A unique range of products and services creates the perfect basis for controlling processes securely and efficiently, protecting individuals from accidents and preventing damage to the environment.

We have extensive experience in a wide range of industries and understand their processes and requirements. With intelligent sensors, we can deliver exactly what our customers need. In application centers in Europe, Asia and North America, system solutions are tested and optimized in accordance with customer specifications. All this makes us a reliable supplier and development partner.

Comprehensive services complete our offering: SICK LifeTime Services provide support throughout the machine life cycle and ensure safety and productivity.

For us, that is “Sensor Intelligence.”

## WORLDWIDE PRESENCE:

Contacts and other locations –[www.sick.com](http://www.sick.com)