



OLM100-1006

OLM100

LINEAR MEASUREMENT SENSORS

SICK
Sensor Intelligence.



Ordering information

Type	Part no.
OLM100-1006	1047413

Other models and accessories → www.sick.com/OLM100



Detailed technical data

Mechanics/electronics

Supply voltage V_s	DC 10 V ... 30 V ¹⁾
Ripple	$\leq 5 V_{pp}$ ²⁾
Power consumption	< 3 W
Initialization time	< 3 s
Enclosure rating	IP65
Protection class	III

¹⁾ Limit values, reverse-polarity protected.

²⁾ May not exceed or fall below U_V tolerances.

Performance

Measuring range	0 m ... 10,000 m ¹⁾
Resolution	0.1 mm, 1 mm
Repeatability	1 mm ²⁾
Output time	1 ms
Light source	LED, red
Max. movement speed	4 m/s
Reading distance	100 mm, ± 20 mm
Barcode width	30 mm

¹⁾ Dependent on the set resolution and transfer protocol.

²⁾ Statistical error 1σ .

Interfaces

CANopen	✓
----------------	---

Ambient data

Electromagnetic compatibility (EMC)	EN 61000-6-2 EN 61000-6-4
--	------------------------------

¹⁾ Temperatures < -20 °C with 5 min warm up time.

²⁾ Max. 95 % humidity, non-condensing.

³⁾ Typ. value at +25 °C ambient temperature.

Ambient temperature, operation	-30 °C ... +60 °C ¹⁾
Ambient temperature, storage	-40 °C ... +75 °C ²⁾
Typ. Ambient light immunity	≤ 5,000 lx ³⁾
Vibration resistance	DIN/EN 60068-2-6, DIN/EN 60068-2-64
Shock resistance	DIN/EN 60068-2-27

¹⁾ Temperatures < -20 °C with 5 min warm up time.

²⁾ Max. 95 % humidity, non-condensing.

³⁾ Typ. value at +25 °C ambient temperature.

Classifications

eCl@ss 5.0	27270890
eCl@ss 5.1.4	27270890
eCl@ss 6.0	27270890
eCl@ss 6.2	27270890
eCl@ss 7.0	27270890
eCl@ss 8.0	27270890
eCl@ss 8.1	27270890
eCl@ss 9.0	27270890
eCl@ss 10.0	27270890
eCl@ss 11.0	27270890
eCl@ss 12.0	27280106
ETIM 5.0	EC001825
ETIM 6.0	EC001825
ETIM 7.0	EC001825
ETIM 8.0	EC001825
UNSPSC 16.0901	39121528

Dimensional drawing (Dimensions in mm (inch))

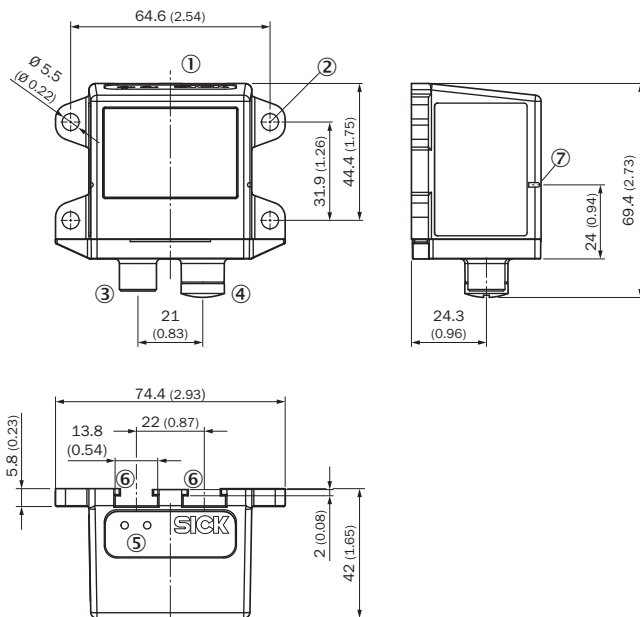

- ① Reference axis position measurement
- ② Mounting holes, \varnothing 5.5 mm
- ③ Connector M12, 5-pin
- ④ Ethernet M12 female connector, 4-pin
- ⑤ Status LED [status]
- ⑥ T-slot
- ⑦ Adjustment aid (slot)

Connection type

OLM100-10x6 1 x socket M12, 4-pin 1 x connector M12, 5-pin

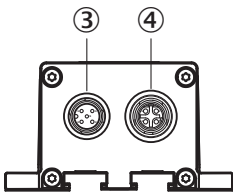

- ③ CANopen
- ④ Ethernet

Connection diagram

OLM100-10x6 1 x socket M12, 4-pin 1 x connector M12, 5-pin

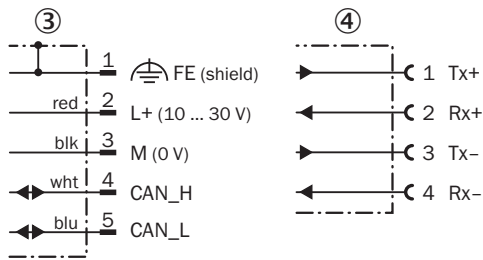

M12 (A-coded)









M12 (D-coded)



③ CANopen

④ Ethernet

Recommended accessories

Other models and accessories → www.sick.com/OLM100

	Brief description	Type	Part no.
Codes			
	30 mm, height: 60 mm, measuring range: customer-specific	Customer-specific bar code tape	5327812
	30 mm, height: 100 mm, measuring range: customer-specific	Customer-specific bar code tape	5327576
	30 mm, height: 25 mm, measuring range: customer-specific	Customer-specific bar code tape	5328960
	30 mm, height: 40 mm, measuring range: customer-specific	Customer-specific bar code tape	5323951
	30 mm, height: 30 mm, measuring range: customer-specific	Customer-specific bar code tape	5322556
Distributors			
	Head A: female connector, M12, 5-pin, A-coded Head B: male connector, M12, 5-pin, A-coded 5-pin	DSC-1205T000025KM0	6030664
Other mounting accessories			
	4 pieces, Sliding nut set, M5, 4x, Included in delivery	Sliding nuts	2017550
Plug connectors and cables			
	Head A: female connector, M12, 5-pin, A-coded Head B: Flying leads Cable: Power, CAN, unshielded, 5 m	D0L-1205-G05M_Can	6021166
	Head A: female connector, M12, 5-pin, straight, A-coded Head B: male connector, M12, 5-pin, straight, A-coded Cable: Power, CANopen, shielded, 1 m	CAN cable (male connector - female connector)	6021164

	Brief description	Type	Part no.
	Head A: male connector, M12, 5-pin, straight, A-coded Cable: CANopen, DeviceNet™, shielded	STE-1205-GA	6027533
	Head A: male connector, M12, 5-pin, straight Cable: CANopen, unshielded	CAN male connector	6021167

Recommended services

Additional services → www.sick.com/OLM100

	Type	Part no.
Warranty extensions		
<ul style="list-style-type: none"> • Product area: Identification solutions, machine vision, Distance sensors, Detection and ranging solutions • Range of services: The services correspond to the scope of the statutory manufacturer warranty (SICK general terms of delivery). • Duration: Five-year warranty from delivery date. 	Extended warranty for a total of five years from delivery date	1680671

SICK AT A GLANCE

SICK is one of the leading manufacturers of intelligent sensors and sensor solutions for industrial applications. A unique range of products and services creates the perfect basis for controlling processes securely and efficiently, protecting individuals from accidents and preventing damage to the environment.

We have extensive experience in a wide range of industries and understand their processes and requirements. With intelligent sensors, we can deliver exactly what our customers need. In application centers in Europe, Asia and North America, system solutions are tested and optimized in accordance with customer specifications. All this makes us a reliable supplier and development partner.

Comprehensive services complete our offering: SICK LifeTime Services provide support throughout the machine life cycle and ensure safety and productivity.

For us, that is “Sensor Intelligence.”

WORLDWIDE PRESENCE:

Contacts and other locations –www.sick.com