



OLS20-BB1114142

OLS

CONTRAST SENSORS

SICK
Sensor Intelligence.



Illustration may differ



Ordering information

Type	Part no.
OLS20-BB114142	1095594

Other models and accessories → www.sick.com/OLS

Detailed technical data

Features

Dimensions (W x H x D)	31 mm x 62 mm x 52.5 mm
Sensing distance	≤ 100 mm
Sensing distance tolerance	± 10 mm
Housing design	Rectangular
Working range	90 mm ... 110 mm
Light source	LED, blue ¹⁾
Wave length	450 nm
Light spot size	180 mm x 9 mm ²⁾
Receiving filters	RG 610
Bar code types	Interleaved 2 of 5
Module width (min.)	≥ 1.5 mm
Line radius (min.)	≥ 0.5 m
Track color	Orange

¹⁾ Average service life: 100,000 h at T_U = +25 °C.

²⁾ Field of view line +90mm, field of view code +50mm.

Mechanics/electronics

Supply voltage	18 V DC ... 30 V DC ¹⁾
Ripple	≤ 5 V _{pp} ²⁾

¹⁾ Limit values when operated in short-circuit protected network: max. 8 A.

²⁾ May not exceed or fall below U_v tolerances.

³⁾ Without load.

Power consumption	< 3 W ³⁾
Sampling rate	5 ms
Accuracy optical center	± 1 mm
Switching output	Push-pull: PNP/NPN
Switching output (voltage)	Push-pull: PNP/NPN HIGH = $U_V - 3\text{ V}$ /LOW ≤ 3 V
Output current I_{max}	< 100 mA
Connection type	Male connector M12, 5-pin
Protection class	III
Circuit protection	U_V connections, reverse polarity protected Output Q short-circuit protected Interference pulse suppression
Enclosure rating	IP67
LED risk group	2 (IEC 62471)
Weight	250 g
Housing material	Zinc diecast

¹⁾ Limit values when operated in short-circuit protected network: max. 8 A.

²⁾ May not exceed or fall below U_V tolerances.

³⁾ Without load.

Communication interface

IO-Link	✓, COM3 (230,4 kBaud)
Cycle time	5 ms
Process data length	21 Byte Process Data In
CANopen	✓
Digital output	Q ₁
Number	1

Ambient data

Ambient operating temperature	-10 °C ... +55 °C
Ambient temperature, storage	-25 °C ... +75 °C
Ambient light immunity	50,000 lx
Shock load	According to IEC 60068
UL File No.	NRKH.E181493 & NRKH7.E181493

Classifications

ECLASS 5.0	27270906
ECLASS 5.1.4	27270906
ECLASS 6.0	27270906
ECLASS 6.2	27270906
ECLASS 7.0	27270906
ECLASS 8.0	27270906
ECLASS 8.1	27270906
ECLASS 9.0	27270906
ECLASS 10.0	27270906

ECLASS 11.0	27270906
ECLASS 12.0	27270906
ETIM 5.0	EC001820
ETIM 6.0	EC001820
ETIM 7.0	EC001820
ETIM 8.0	EC001820
UNSPSC 16.0901	39121528

Dimensional drawing (Dimensions in mm (inch))

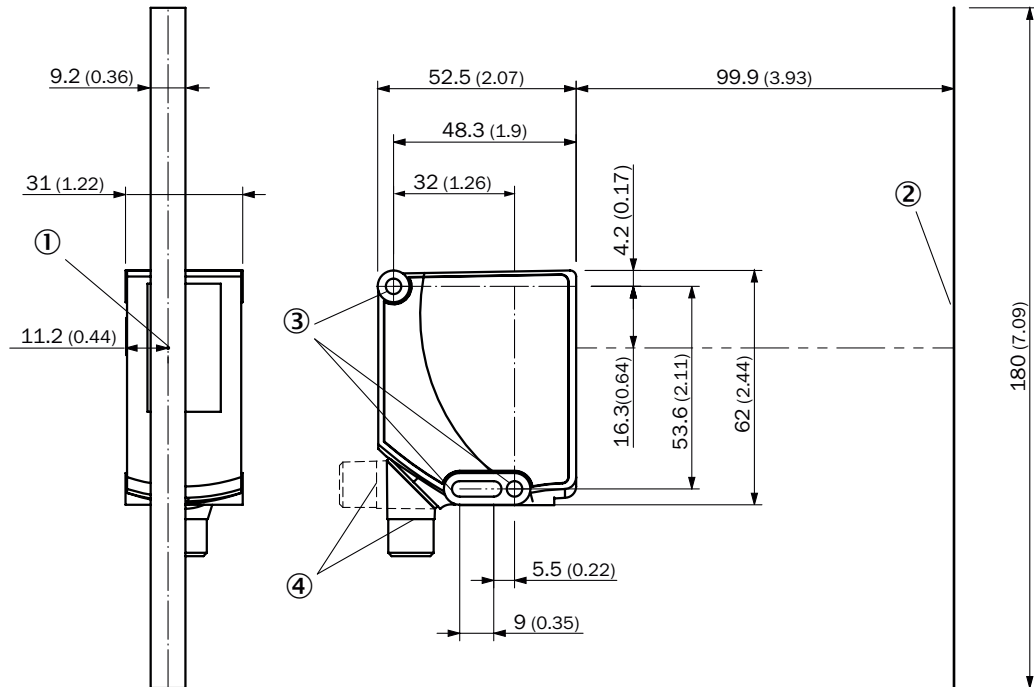

- ① Optical axis
- ② Field of view
- ③ Mounting hole, \varnothing 4.1 mm
- ④ Connector M12 (rotatable up to 180°)

Connection diagram

Cd-422

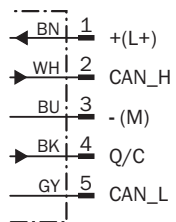

Adjustments

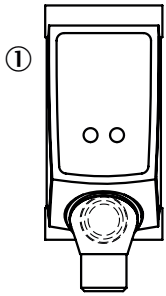



① Indicator lamps

Recommended accessories

Other models and accessories → www.sick.com/OLS

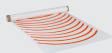
	Brief description	Type	Part no.
Connection modules			
	IO-Link V1.1 Class A port, USB2.0 port, optional external power supply 24V / 1A	IOLA2US-01101 (SiLink2 Master)	1061790
Universal bar clamp systems			
	Plate N04 for universal clamp, steel, Zinc plated steel (sheet), Zinc die cast (clamping bracket), Universal clamp (5322626), mounting hardware	BEF-KHS-N04	2051610
	Mounting bar, straight, 200 mm, steel, steel, zinc coated, without mounting hardware	BEF-MS12G-A	4056054
	Mounting bar, L-shaped, 250 x 250 mm, steel, steel, zinc coated, without mounting hardware	BEF-MS12L-B	4056053
Codes			
	Luminescent duct tape for easy application to all types of flooring, width 2.5 cm, length 25 m, neon orange	ADHESIVE TAPE, FABRIC	5337868
	1D bar codes in 2/5 interleaved format, set of 108 bar codes, 9 A4 sheets of 12 bar codes each, luminescent PVC base material with protective film, codes 0001 ... 0108, neon orange	BARCODE 7510-038-0001-0108	5338408
	Scope of delivery: 1 x 90° arc, protective film for adhesive tape, slip resistance class R10, protection against abrasion and moisture, prepared as 90° arc with a radius of 1,000 mm	TAPE 250AS-100-35	5338390
	Protective film for adhesive tape, slip resistance class R10, protection against abrasion and moisture, width 3,5 cm, length 50 m	TAPE 250AS-35-50	5338386
	Scope of delivery: 1 x 90° arc, protective film for adhesive tape, slip resistance class R10, protection against abrasion and moisture, prepared as 90° arc with a radius of 500 mm	TAPE 250AS-500-35	5338389
	Scope of delivery: 1 x 90° arc, luminescent rugged PVC adhesive tape, prepared as 90° arc with a radius of 1,000 mm, neon orange	TAPE 7510-038-1000	5338388

	Brief description	Type	Part no.
	Luminescent rugged PVC adhesive tape for easy application to all types of flooring, width 2 cm, length 25 m, neon orange	TAPE 7510-038-20-25	5338378
	Scope of delivery: 1 x 90° arc: luminescent rugged PVC adhesive tape, prepared as 90° arc with a radius of 500 mm, neon orange	TAPE 7510-038-500	5338387
	<ul style="list-style-type: none"> • Connection type head A: Male connector, M12, 5-pin, straight, A-coded • Description: Unshielded, Head A: male connector, M12, 5-pin, straight, unshielded, for cable diameter 4 mm ... 6 mm Head B: - • Connection systems: Screw-type terminals • Permitted cross-section: ≤ 0.75 mm² • Note: For field bus technology 	STE-1205-G	6022083
	<ul style="list-style-type: none"> • Connection type head A: Female connector, M12, 5-pin, straight, A-coded • Connection type head B: Flying leads • Signal type: Sensor/actuator cable • Cable: 5 m, 5-wire, PVC • Description: Sensor/actuator cable, unshielded • Application: Zones with chemicals 	YF2A15-050VB5XLEAX	2096240

Recommended services

Additional services → www.sick.com/OLS

	Type	Part no.
Pre-configuration		
<ul style="list-style-type: none"> • Product area: OLS • Voraussetzungen: SOPAS ET file or sensor app which contains the necessary configuration and is coordinated to the customer application, Uploading of the configuration or the SOPAS ET file or sensor app • Range of services: Production and delivery of one or several personalized SICK products with the configuration uploaded by the customer and selected in the web ordering process • Documentation: Additional label on the SICK product and its packaging with the configuration name specified by the customer and a unique configuration ID • Duration: The delivery time of the pre-configured and customer-specific SICK product is identical, or in the case of temporary storage, a few days longer than with a standard SICK product 	Pre-configuration OLS20	1615148

SICK AT A GLANCE

SICK is one of the leading manufacturers of intelligent sensors and sensor solutions for industrial applications. A unique range of products and services creates the perfect basis for controlling processes securely and efficiently, protecting individuals from accidents and preventing damage to the environment.

We have extensive experience in a wide range of industries and understand their processes and requirements. With intelligent sensors, we can deliver exactly what our customers need. In application centers in Europe, Asia and North America, system solutions are tested and optimized in accordance with customer specifications. All this makes us a reliable supplier and development partner.

Comprehensive services complete our offering: SICK LifeTime Services provide support throughout the machine life cycle and ensure safety and productivity.

For us, that is “Sensor Intelligence.”

WORLDWIDE PRESENCE:

Contacts and other locations –www.sick.com